

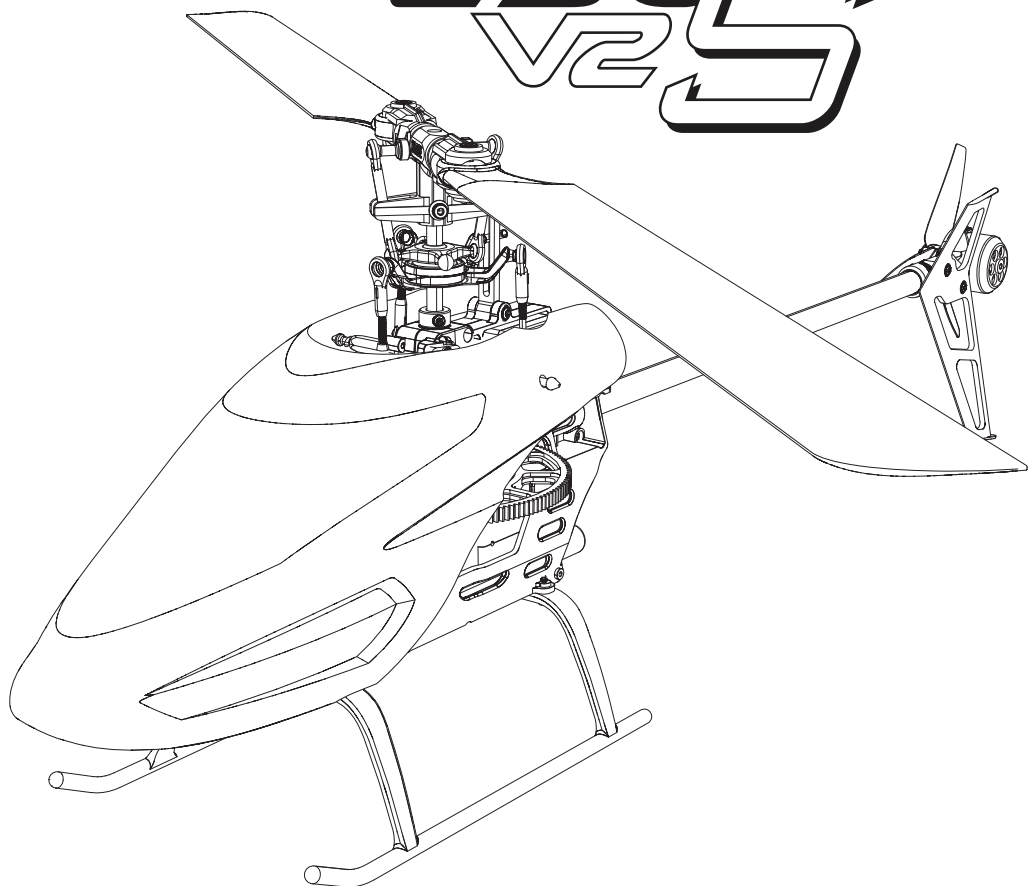

BLADE®

230
V2S



Instruction Manual
Bedienungsanleitung
Manuel d'utilisation
Manuale di Istruzioni

SAFE®

RTF

BNF
BASIC

NOTICE

All instructions, warranties and other collateral documents are subject to change at the sole discretion of Horizon Hobby, LLC. For up-to-date product literature, visit horizonhobby.com and click on the support tab for this product.

Meaning of Special Language

The following terms are used throughout the product literature to indicate various levels of potential harm when operating this product:

WARNING: Procedures, which if not properly followed, create the probability of property damage, collateral damage, and serious injury OR create a high probability of superficial injury.

CAUTION: Procedures, which if not properly followed, create the probability of physical property damage AND a possibility of serious injury.

NOTICE: Procedures, which if not properly followed, create a possibility of physical property damage AND a little or no possibility of injury.



WARNING: Read the ENTIRE instruction manual to become familiar with the features of the product before operating. Failure to operate the product correctly can result in damage to the product, personal property and cause serious injury.

This is a sophisticated hobby product. It must be operated with caution and common sense and requires some basic mechanical ability. Failure to operate this Product in a safe and responsible manner could result in injury or damage to the product or other property. This product is not intended for use by children without direct adult supervision. Do not use with incompatible components or alter this product in any way outside of the instructions provided by Horizon Hobby, LLC. This manual contains instructions for safety, operation and maintenance. It is essential to read and follow all the instructions and warnings in the manual, prior to assembly, setup or use, in order to operate correctly and avoid damage or serious injury.

Age Recommendation: Not for children under 14 years. This is not a toy.

Safety Precautions and Warnings

- Always keep a safe distance in all directions around your model to avoid collisions or injury. This model is controlled by a radio signal subject to interference from many sources outside your control. Interference can cause momentary loss of control.
- Always operate your model in open spaces away from full-size vehicles, traffic and people.
- Always carefully follow the directions and warnings for this and any optional support equipment (chargers, rechargeable battery packs, etc.).
- Always keep all chemicals, small parts and anything electrical out of the reach of children.
- Always avoid water exposure to all equipment not specifically designed and protected for this purpose. Moisture causes damage to electronics.
- Never place any portion of the model in your mouth as it could cause serious injury or even death.
- Never operate your model with low transmitter batteries.
- Always keep aircraft in sight and under control.
- Always move the throttle fully down at rotor strike.
- Always use fully charged batteries.
- Always keep transmitter powered on while aircraft is powered.
- Always remove batteries before disassembly.
- Always keep moving parts clean.
- Always keep parts dry.
- Always let parts cool after use before touching.
- Always remove batteries after use.
- Never operate aircraft with damaged wiring.
- Never touch moving parts.



WARNING AGAINST COUNTERFEIT PRODUCTS: If you ever need to replace your Spektrum receiver found in a Horizon Hobby product, always purchase from Horizon Hobby, LLC or a Horizon Hobby authorized dealer to ensure authentic high-quality Spektrum product. Horizon Hobby, LLC disclaims all support and warranty with regards, but not limited to, compatibility and performance of counterfeit products or products claiming compatibility with DSM or Spektrum technology.

Table of Contents

First Flight Preparation.....	4	Flying	11
Flying Checklist	4	Advanced Settings	12
Charging Warnings.....	4	Servo Adjustment	15
Using the Included Charger (BNF Only).....	4	Trim Flight	16
Installing the DXe Transmitter Batteries (RTF).....	5	Calibration Procedure	17
DXe Transmitter Control (RTF)	5	Post-Flight Inspection and Maintenance Checklist.....	18
Transmitter Setup (BNF)	6	Troubleshooting Guide	18
Installing the Flight Battery	7	Exploded View	20
Transmitter and Receiver Binding.....	7	Parts Listings	20
SAFE® Technology	8	Optional Parts	21
Flight Mode and Rate Selection.....	8	Limited Warranty	21
Panic Recovery	8	Warranty and Service Contact Information	22
Throttle Hold.....	9	FCC Information.....	22
Control Tests.....	9	IC Information.....	23
Understanding the Primary Flight Controls	10	Compliance Information for the European Union.....	23

Specifications

Length	18.66 in (474mm)	Tail Rotor Diameter	3.25 in (82.5mm)
Height	6.46 in (164 mm)	Flying Weight	11.95oz (339 g)
Main Rotor Diameter	21.10in (536mm)		

Components		RTF (BLH1400)	BNF- Basic (BLH1450)
Airframe (A)	Blade 230 S V2	Included	
Main Motor	3900Kv Brushless (EFLH1516)	Installed	
Tail Motor	3600Kv Brushless (BLH1512)	Installed	
Receiver	Blade 230 S V2 AS3X®/ SAFE® receiver (BLH1427)	Installed	
ESC	Dual Brushless ESC (BLH1425)	Installed	
Battery (B)	800mAh 3S 11.1V 30C Li-Po (EFLB8003SJ30)	Included	Not Included
Charger (C)	3S Li-Po Balancing Charger (EFLC3105) with AC to DC adaptor	Included	Not Included
Transmitter (D)	DSM2®/DSMX® Compatible Transmitter (SPM1000)	Included	Not Included
Batteries (E)	AA Alkaline cells	Included	Not Included

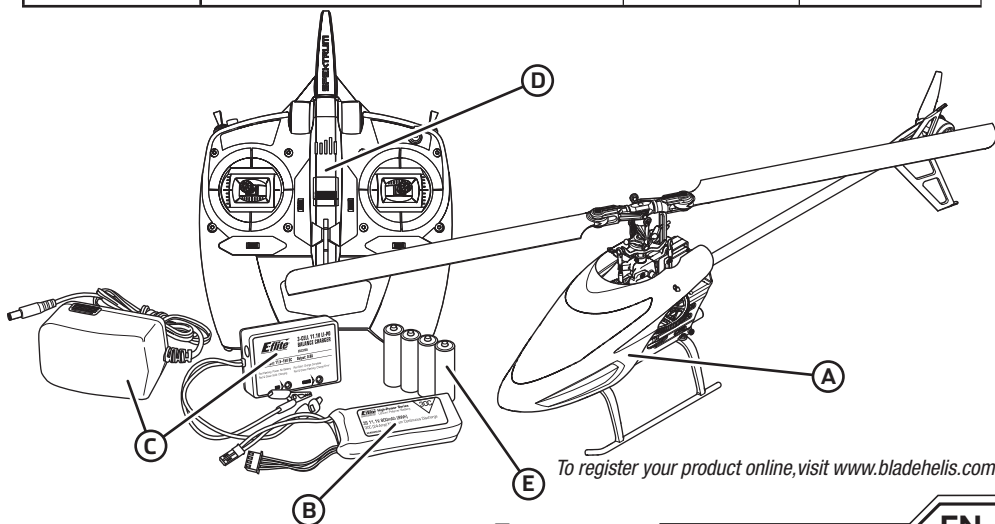

To register your product online, visit www.bladehelis.com

First Flight Preparation

- Remove and inspect contents
- Begin charging the flight battery
- Program your computer transmitter (BNF only)
- Charge the flight battery
- Install the flight battery
- Bind your transmitter (BNF only)
- Familiarize yourself with the controls
- Find a suitable area for flying

Charging Warnings



CAUTION: All instructions and warnings must be followed exactly. Mishandling of Li-Po batteries can result in a fire, personal injury and/or property damage.

- **NEVER LEAVE CHARGING BATTERIES UNATTENDED.**
- **NEVER CHARGE BATTERIES OVERNIGHT.**
- By handling, charging or using the included Li-Po battery, you assume all risks associated with lithium batteries.
- If at any time the battery begins to balloon or swell, discontinue use immediately. If charging or discharging, discontinue and disconnect. Continuing to use, charge or discharge a battery that is ballooning or swelling can result in fire.
- Always store the battery at room temperature in a dry area for best results.
- Always transport or temporarily store the battery in a temperature range of 40–120° F (5–49° C).
- Do not store battery or model in a car or direct sunlight. If stored in a hot car, the battery can be damaged or even catch fire.

Using the Included Charger (RTF)

NOTICE: Charge only batteries that are cool to the touch and are not damaged. Look at the battery to make sure it is not damaged e.g., swollen, bent, broken or punctured.

1. Connect the AC to DC adapter to an AC outlet.
2. Connect the AC to DC adapter to the charger.
3. Connect the battery balance lead to the charger. The connector is keyed to prevent reverse polarity connection.
4. Always disconnect the flight battery from the charger immediately upon completion of charging.

LED Indicators

Red Flashing LED: Input power with no battery connected

Red and Green Solid LEDs: Battery connected and charging

Red Solid LED: Charge complete

Red and Green Flashing LEDs: Charge error

Charging a fully discharged (not over-discharged) 800mAh battery takes approximately 1–1.5 hours.

The charger can also be powered through the DC alligator clips. Connect them to a 11.5–15V DC power source, noting proper polarity.

Flying Checklist

- Always turn the transmitter on first**
- Plug the flight battery into the lead from the ESC
- Allow the receiver and ESC to initialize and arm properly
- Fly the model
- Land the model
- Unplug the flight battery from the ESC
- Always turn the transmitter off last**

- Always charge batteries away from flammable materials.
- Always inspect the battery before charging
- Always disconnect the battery after charging, and let the charger cool between charges.
- Always constantly monitor the temperature of the battery pack while charging.
- **ONLY USE A CHARGER SPECIFICALLY DESIGNED TO CHARGE LI-PO BATTERIES.** Failure to charge the battery with a compatible charger may cause a fire resulting in personal injury and/or property damage.
- Never discharge Li-Po cells to below 3V under load.
- Never cover warning labels with hook and loop strips.
- Never charge batteries outside recommended levels.
- Never charge damaged batteries.
- Never attempt to dismantle or alter the charger.
- Never allow minors to charge battery packs.
- Never charge batteries in extremely hot or cold places (recommended between 40–120° F or (5–49° C) or place in direct sunlight.

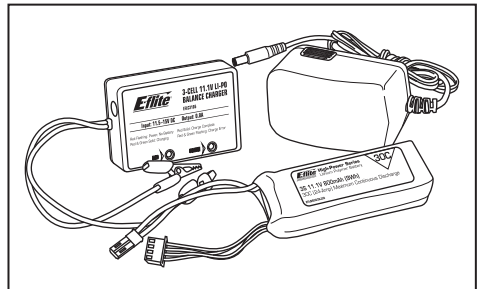

CAUTION: Do not connect to AC and DC power sources at the same time. Doing so may cause a short circuit, resulting in damage to the product, personal injury or property damage.

NOTICE: Always connect cable polarities correctly. Consult the battery instructions, safety sheet or product support before using a 12V battery with sources other than a standard AC wall outlet.

Installing the DXe Transmitter Batteries (RTF)

Replace the transmitter batteries when the transmitter begins to beep continuously.

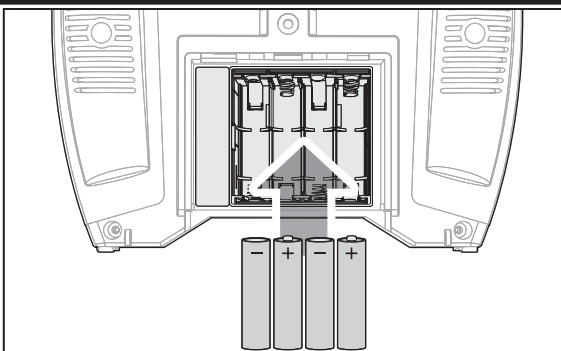

DXe Transmitter Control (RTF)

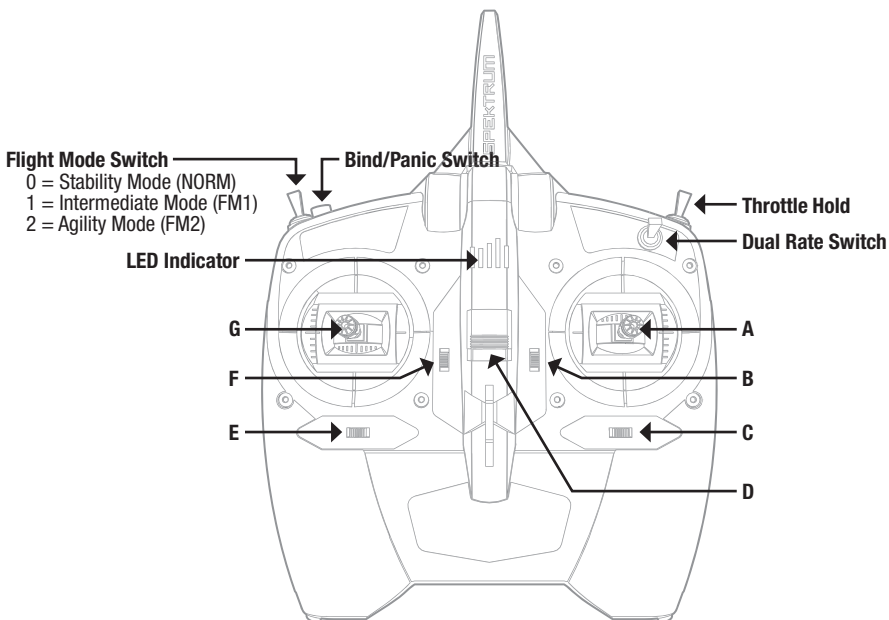

	A	B	C	D	E	F	G
Mode 1	Aileron (Left/Right) Throttle (Up/Down)	Throttle Trim	Aileron Trim	ON/OFF Switch	Rudder Trim	Elevator Trim	Rudder (Left/Right) Elevator (Up/Down)
Mode 2	Aileron (Left/Right) Elevator (Up/Down)	Elevator Trim	Aileron Trim	ON/OFF Switch	Rudder Trim	Throttle Trim	Rudder (Left/Right) Throttle (Up/Down)

Transmitter Setup Table (BNF)

DX6i

SETUP LIST		ADJUST LIST				
Model Type	HELI	TRAVEL ADJ				
Swash Type	1 servo Normal	Channel	Travel			
REVERSE		THRO	100/100			
Channel	Direction	AILE	100/100			
THRO	N	ELEV	100/100			
AILE	N	RUDD	100/100			
ELEV	N	GYRO	100/100			
RUDD	N	PITC	100/100			
GYRO	N	GYRO				
PITC	R	RATE	SW-F.MODE			
Modulation Type		0	88%	NORM	0	
AUTO DSMX-ENABLE		1	12%	STUNT	1	
D/R COMBI		Throttle Curve				
D/R SW	AILE	Switch Pos (F Mode)	Pos 1	Pos 2	Pos 3	
		NORM	0	25	50	
		STUNT	85	85	85	
			85	85	85	
D/R & Expo		Mix 1				
Chan	Sw Pos	D/R	Expo			
AILE	0	100	+25			
	1	75	+25			
ELEV	0	100	+25			
	1	75	+25			
RUDD	0	100	+25			
	1	75	+25			
Mix 1		GYRO->GYRO ACT				
Rate	D+125%	U+125%				
SW	ELE D/R	TRIM - INH				
Pitch Curve		Timer				
Switch Pos (F Mode)	Pos 1	Pos 2	Pos 3	Pos 4	Pos 5	
NORM	30	40	50	75	100	
STUNT	0	25	50	75	100	
HOLD	25	37	50	75	100	
Down Timer		5:00				
Switch		THR CUT				

Panic Mode Operation

ELEV D/R Switch

Sw Pos 0 = Panic Mode Off

Sw Pos 1 = Panic Mode On

Once the model has returned to level you must manually return the Panic Mode Switch to the off position otherwise the cyclic and tail rotor controls will be reduced.

DX6e, DX6, DX7, DX8, DX9, DX18, DX20, ix12

SYSTEM SETUP		FUNCTION LIST			
Model Type	HELI	Servo Setup			
Swash Type	Normal	Chan	Travel	Reverse	
F-Mode Setup		THR	100/100	Normal	
Switch 1	Switch B	AILE	100/100	Normal	
Switch 2	Inhibit	ELE	100/100	Normal	
Hold Switch	Switch H	RUD	100/100	Normal	
	0 1	GER	100/100	Normal	
Channel Assign		D/R & Expo			
Channel Input Config		Chan	Sw (F) Pos	D/R	Expo
1 Throttle		AILE	0	100/100	+25
2 Aileron			1	100/100	+25
3 Elevator			2	75/75	+25
4 Rudder		ELEV	0	100/100	+25
5 Gear	Switch B		1	100/100	+25
6 Collective			2	75/75	+25
7 AUX 2		RUDD	0	100/100	+25
			1	100/100	+25
			2	75/75	+25
Frame Rate		Gyro			
11ms		Inhibit			
DSMX		Timer			
Panic Mode Operation		Mode	Count Down		
Bind / I Button		Time	5:00v		
Pressed = Panic Mode On		Start	Throttle Out		
Released = Panic Mode Off		Over	25%		
		One Time	Inhibit		
		Throttle Curve			
		Sw (B) Pos	Pt 1	Pt 2	Pt 3
		N	0	25	50
		1	85	85	85
		2	100	100	100
		Pitch Curve			
		Sw (B) Pos	Pt 1	Pt 2	Pt 3
		N	30	40	50
		1	0	25	50
		2	0	25	50
		HOLD	25	37	50
		Mixing			
		Normal			
		P-Mix 1	Channels	-I -> Ger	
			Rate	0/-125	
			Offset	100	
			Switch	Switch I	
			Position	0	1

Installing the Flight Battery

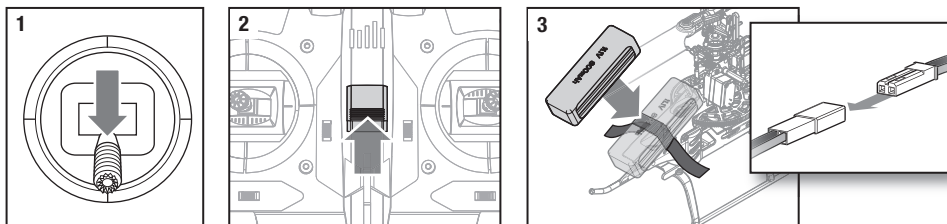

1. Lower the throttle stick to the lowest position.
2. Power ON the transmitter.
3. Center all trims. For the included Spektrum DXe transmitter (RTF only), the trims are centered when you hear a higher pitched beep while pressing the trim button. Move the trim in both directions until you hear the high-pitched beep.
4. Attach the hook material to the helicopter frame and the loop material to the flight battery.
5. Install the flight battery on the helicopter frame.
Secure the flight battery with the hook and loop strap.

NOTICE: If the flight battery velcro strap is pulled too tight, it may result in a vibration or the tail rotor may drift to the right during flight. If you experience either of these issues, loosen the strap slightly and fly again.

6. Connect the battery connector to the ESC, noting correct polarity.

CAUTION: Connecting the battery to the ESC with reversed polarity will cause damage to the ESC, the battery or both. Damage caused by incorrectly

connecting the battery is not covered under warranty.

7. Place the helicopter on a flat surface and leave it still until the ESC beeps twice and the blue LED glows solid, indicating initialization is complete. If you experience issues during initialization, refer to the Troubleshooting Guide at the back of the manual.

CAUTION: Always disconnect the Li-Po battery from the aircraft when not flying to avoid over-discharging the battery. Batteries discharged to a voltage lower than the lowest approved voltage may become damaged, resulting in loss of performance and potential fire when batteries are charged.

WARNING: Always activate throttle hold and wait until the main rotor blades and tail rotor stop spinning before handling the model.

The throttle trim on the transmitter must remain at the center position. Raising the throttle trim above center may cause the main and tail motors to begin spinning.

Transmitter and Receiver Binding



This product requires an approved Spektrum DSM2®/DSMX® compatible transmitter. Visit www.bindnfly.com for a complete list of approved transmitters.

General Binding Procedure

1. Disconnect the flight battery from the helicopter.
2. Refer the Transmitter Setup Table to correctly setup your transmitter.
3. Lower the throttle stick to the lowest position. Set all trims to the center position.
4. Power off the transmitter and move all switches to the 0 position. Move the throttle to the low/off position.
5. Install the bind plug in the receiver BIND/PROG port (far left side of the receiver).
6. Connect the flight battery to the ESC. The receiver LED flashes, indicating it is in bind mode.
7. Put the transmitter into bind mode while powering on the transmitter.
8. Release the bind button/switch after 2–3 seconds. The helicopter is bound when the LED on the receiver turns solid.
9. Disconnect the flight battery and power the transmitter off.

CAUTION: When using a Futaba® transmitter with a Spektrum™ DSM2® module, you must reverse the throttle channel and re-bind. Refer to your Spektrum module manual for binding and failsafe instructions. Refer to your Futaba transmitter manual for instructions on reversing the throttle channel.

DXe Binding Procedure

1. Disconnect the flight battery from the helicopter.
2. Lower the throttle stick to the lowest position. Set all trims to the center position.
3. Power off the transmitter.
4. Install the bind plug in the receiver BIND/PROG port (far left side of the receiver).
5. Connect the flight battery to the ESC. The receiver LED flashes, indicating it is in bind mode.
6. Press and hold the Bind Switch while powering on the transmitter.
7. The transmitter will beep and the LED will blink. Release the Bind Switch.
8. The helicopter is bound when the LED on the receiver control unit is solid and the transmitter emits 3 rapid, high-pitch tones. If the transmitter emits 2 low-pitch tones, the binding procedure was not successful and should be attempted again.
9. Disconnect the flight battery and power the transmitter off.

If you encounter problems, obey binding instructions and refer to the troubleshooting guide for other instructions. If needed, contact the appropriate Horizon Product Support office.

SAFE Technology

Revolutionary SAFE® (Sensor Assisted Flight Envelope) technology uses an innovative combination of multi-axis sensors and software that allows model aircraft to know its position relative to the horizon. This spatial awareness is utilized to create a controlled flight envelope the aircraft can use to maintain a safe region of bank and pitch angles so you can fly more safely. Far beyond stability, this level of protection offers multiple modes so the pilot can choose to develop his or her skills with a greater degree of security and flight control that always feels crisp and responsive.

SAFE technology delivers:

- Flight envelope protection you can enable at the flip of a switch.
- Multiple modes let you adapt SAFE technology to your skill level instantly.

Best of all, sophisticated SAFE technology doesn't require any work to enjoy. Every aircraft with SAFE installed is ready to use and optimized to offer the best possible flight experience.

FlySAFERC.com

Flight Mode and Rate Selection

In **Stability Mode** the bank angle is limited. When the cyclic stick is released the model will return to level.

In **Intermediate Mode** the bank angle is not limited. When the cyclic stick is released the model will not return to level. This mode is great for learning forward flight and basic aerobatics such as stall turns and loops.

In **Agility Mode** the bank angle is not limited. When the cyclic stick is released the model will not return to level. This mode is great for 3D aerobatics such as stationary flips and tic tocs.

Change rates in any mode by moving the two-position dual rate switch.

- Low rate reduces the control rates, providing an easier to fly model. Beginners should use low rate for initial flights.
- High rate provides full control and should be used by intermediate and experience pilots.

Panic Recovery

If you get into distress while flying in any mode, activate the panic function and move the control sticks to their neutral position. SAFE technology will immediately return the aircraft to an upright level attitude, if the aircraft is at a sufficient height with no obstacles in its path. Return the collective stick to 50% and deactivate the Panic Recovery Function to return to the current flight mode.

NOTICE: Before deactivating Panic Recovery, make sure the collective stick has been returned to the 50% position. Once the Panic Recovery has been deactivated, full negative collective becomes available, which could cause the 230 S V2 to descend rapidly.

- This mode is intended to provide the pilot with the confidence to continue to improve their flight skills.
- Move the collective stick to 50% and return all other transmitter controls to neutral for the quickest recovery.
- Once the model has reached a level upright attitude, the negative collective is reduced to prevent the user from pushing the model into the ground.

Throttle Hold

Throttle hold is used to prevent the motor from powering on inadvertently. For safety, turn throttle hold ON any time you need to touch the helicopter or check the direction controls.

Control Tests

Ensure the throttle hold is ON when doing the direction control tests. Test the controls prior to the first flight to ensure the servos, linkages and parts operate correctly.

Throttle hold is also used to turn off the motor quickly if the helicopter is out of control, in danger of crashing, or both. The blades will continue to spin briefly when throttle hold is activated.

Elevator

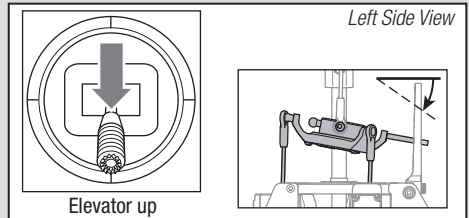
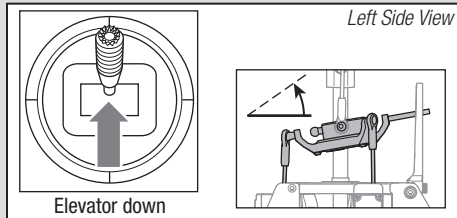

Aileron

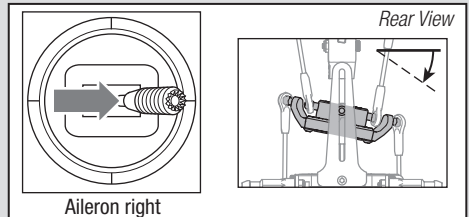
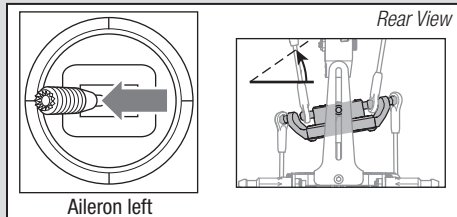

Collective Pitch

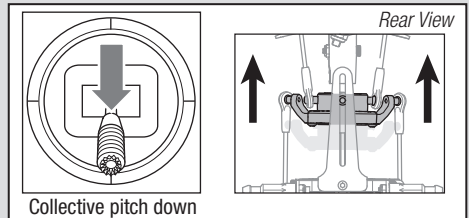
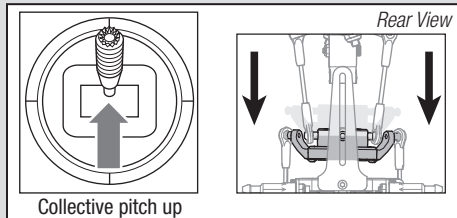

Motor

Place the helicopter outdoors on a clean, flat and level surface (concrete or asphalt) free of obstructions. Always stay clear of moving rotor blades.

CAUTION: Keep pets and other animals away from the helicopter. Animals may injure themselves if they attack or run toward the helicopter.

- Both motors beep 3 times when the helicopter's ESC arms properly. Before you continue, confirm that throttle is at full low position.
- Turn Throttle Hold OFF.

WARNING: Stay at least 30 feet (10 meters) away from the helicopter when the motor is running. Do not attempt to fly the helicopter at this time.

- Slowly increase the throttle until the blades begin to spin. The main blades should spin clockwise when viewing the helicopter from the top. The tail rotor blades should spin counterclockwise when viewing the helicopter from the right side.

NOTICE: If the main rotor blades are spinning counterclockwise, reduce the throttle to low immediately. Disconnect the battery from the helicopter and reverse any two motor wire connections to the ESC and repeat the motor control test.

Understanding the Primary Flight Controls

If you are not familiar with the controls of your aircraft, take a few minutes to familiarize yourself with them before attempting your first flight.

Collective

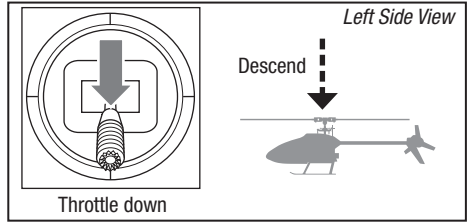
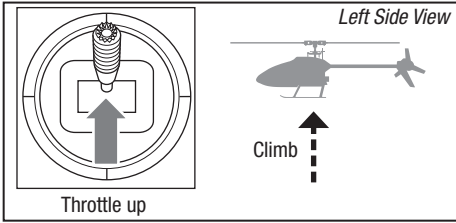

Rudder

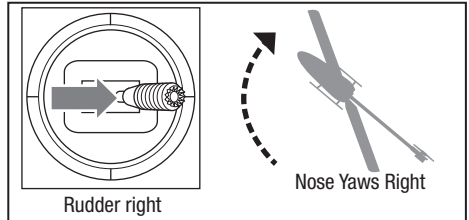
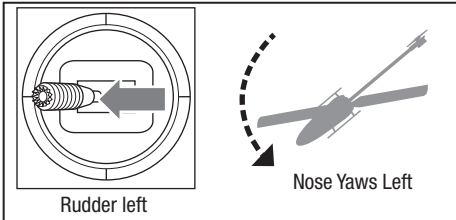

Elevator

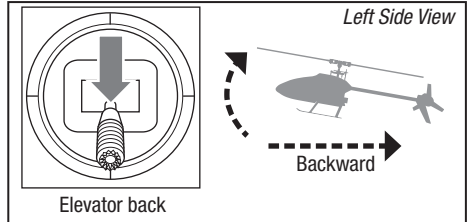
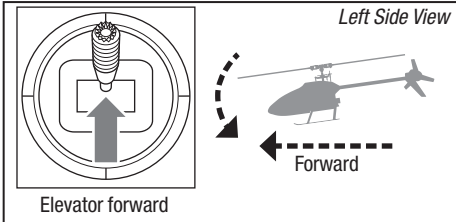

Aileron

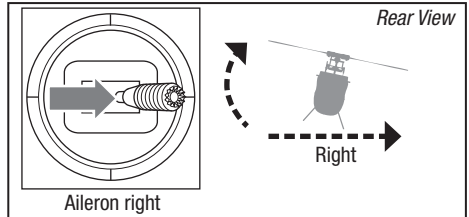
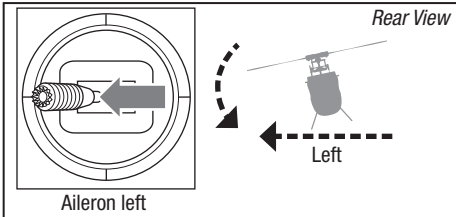

Flying the 230 S V2

Consult your local laws and ordinances before choosing a location to fly your aircraft.

We recommend flying your aircraft outside in calm winds or inside a large gymnasium. Always avoid flying near houses, trees, wires and buildings. You should also be careful to avoid flying in areas where there are many people, such as busy parks, schoolyards or soccer fields.

It is best to fly from a smooth flat surface as this will allow the model to slide without tipping over. Keep the helicopter approximately 2 ft (600mm) above the ground. Keep the tail pointed toward you during initial flights to keep the control orientation consistent. Releasing the stick in Stability Mode will allow the helicopter to level itself. Activating the Panic Recovery button will level the helicopter quickly. If you become disoriented while in Stability Mode, slowly lower the throttle stick to land softly.

During initial flights, only attempt takeoff, landing and hovering in one spot.

Takeoff

NOTICE: If the main motor or tail motor do not start up properly when throttle is first applied, immediately return the throttle to the low position and try again. If the problem persists, disconnect the flight battery, check for binding in the gear train and ensure no wires have become entangled within the gears.

Place the model onto a flat, level surface free of obstacles and walk back 30 feet (10 meters). Slowly increase the throttle until the model is approximately 2 ft. (600mm) off the ground and begin flying the model.

Hovering

Making small corrections on the transmitter, try to hold the helicopter in one spot. If flying in calm winds, the model should require almost no corrective inputs. After moving the cyclic stick and returning it to center, the model should level itself. The model may continue to move due to inertia. Move the cycle stick in the opposite direction to stop the movement.

After you become comfortable hovering, you can progress into flying the model to different locations, keeping the tail pointed towards you at all times. You can also ascend and descend using the throttle stick. Once you're comfortable with these maneuvers, you can attempt flying with the tail in different orientations. It is important to keep in mind that the flight control inputs will rotate with the helicopter, so always try to picture the control inputs relative to the nose of the helicopter. For example, forward will always drop the nose of the helicopter.

Low Voltage Cutoff (LVC)

LVC decreases the power to the motors when the battery voltage gets low. When the motor power decreases and the red LED on the ESC flashes, land the aircraft immediately and recharge the flight battery.

LVC does not prevent the battery from over-discharge during storage.

NOTICE: Repeated flying to LVC will damage the battery.

Landing

To land, slowly decrease the throttle while in a low-level hover. After landing, disconnect and remove the battery from the aircraft after use to prevent trickle discharge. Review your manufacturers provided LiPo guidelines for charging and storage information.

Advanced Settings

The 230 S V2 default settings are appropriate for most users. We recommend flying with the default parameters before making any adjustments.

Telemetry Based Text Generator for Advanced Settings

Advanced parameters may be easily read in text form when using a Spektrum™ telemetry based transmitter. Transmitters may require a firmware update to access this function. To register and update Spektrum™ transmitters, visit www.spektrumrc.com.

Turning On Text Gen

Access the Telemetry menu, select one of the “Empty” Telemetry slots and scroll to select “Text Gen.” Set the display option to active (Act). Once the Text Gen message feature has been enabled, the transmitter will display text based menus on the telemetry screens for adjusting PID values and servo center points. The helicopter must be bound and initialized for the Text Gen screen to function; scroll from the home screen past the telemetry screen(s) to access the Text Gen screen.

Using Text Gen

The available features and stick inputs used to manipulate the menus are the same as the methods outlined in the following section, but using the text based programming is more intuitive. Refer to the transmitter manual for details on how to utilize telemetry menus.



WARNING: To ensure your safety, always disconnect the motor wires from the ESC before performing the following steps. After you have completed the adjustments, reconnect the motor wires to the ESC before attempting to fly the model.

Telemetry		LIST
Auto-Config	6: Empty	
1: Text Gen	7: Empty	
2: Empty	8: Empty	
3: Empty	9: Empty	
4: Empty	10: Rx V	
5: Empty	11: Flight Log	
Settings	File Settings	

Blade 230 S	
Version 4.40	
[Cyclic]	
P	>100
I	100
D	100
Feel	100

Advanced Settings

Gain Parameters

1. Cyclic P Gain Adjustment (Default 100%)

Higher gain will result in greater stability. Setting the gain too high may result in random twitches if your model has an excessive level of vibration. High frequency oscillations may also occur if the gain is set too high.

Lower gain will result in less stability. Too low of a value may result in a less stable model, particularly outdoors in winds.

If you are located at a higher altitude or in a warmer climate, higher gains may be beneficial—the opposite is true for lower altitude or colder climates.

2. Cyclic I Gain Adjustment (Default 100%)

Higher gain will result in the model remaining still, but may cause low frequency oscillations if increased too far.

Lower gain will result in the model drifting slowly.

If you are located at a higher altitude or in a warmer climate, higher gains may be beneficial—the opposite is true for lower altitude or colder climates.

3. Cyclic D Gain Adjustment (Default 100%)

Higher gain will improve the response rate of your inputs.

If the gain is raised too much, high frequency oscillations may occur.

Lower gain will slow down the response to inputs.

4. Cyclic Response (Default 100%)

Higher cyclic response will result in a more aggressive cyclic response.

Lower cyclic response will result in a less aggressive cyclic response.

5. Tailrotor P Gain Adjustment (Default 100%)

Higher gain will result in greater stability. Setting the gain too high may result in random twitches if your model has an excessive level of vibration. High frequency oscillations may also occur if the gain is set too high.

Lower gain may result in a decrease in stability. Too low of a value may result in a less stable model particularly outdoors in winds.

If you are located at a higher altitude or in a warmer climate, higher gains may be beneficial—the opposite is true for lower altitude or colder climates.

6. Tailrotor I Gain Adjustment (Default 100%)

Higher gain results in the tail remaining still. If the gain is raised too far, low speed oscillations may occur.

Lower gain will result in the tail drifting in flight over time.

If you are located at a higher altitude or in a warmer climate, higher gains may be beneficial—the opposite is true for lower altitude or colder climates.

7. Tailrotor D Gain Adjustment (Default 100%)

Higher gain will improve the response rate to your inputs.

If raised too far, high frequency oscillations may occur.

Lower gain will slow down the response to inputs, but will not have an effect on stability.

8. Tailrotor Adaptive Filtering

Higher gain will reduce oscillations during high speed flight and when using large amounts of collective.

Lower gain will improve tail performance but may lead to tail oscillations.

Entering Gain Adjustment Mode

1. Lower the throttle stick to the lowest position.
2. Power ON the transmitter.
3. Install the flight battery on the helicopter frame, securing it with the hook and loop strap.
4. Connect the battery connector to the ESC.
5. Place the helicopter on a flat surface and leave it still until the orange receiver LED glows solid, indicating initialization is complete.
6. Set the rate switch on the transmitter to the high rate.

7. Move and hold both transmitter sticks to the bottom right corner as shown.

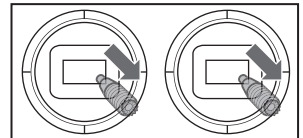

8. Activate the panic recovery function until the swash servos move.
9. Release the sticks and deactivate panic recovery. The model is now in Gain Adjustment Mode.
10. Proceed to Adjusting the Gain Values to make any desired changes.

Advanced Settings

Adjusting the Gain Values

If you are using a Spektrum™ telemetry-enabled transmitter, the gain adjustments can be viewed on the Flight Log screen. Refer to your transmitter instructions to locate this screen. The gain parameter currently selected will flash on the transmitter screen. If you are not using a Spektrum telemetry-enabled transmitter, the parameter and gain values are indicated by the position of the swashplate on the helicopter.

Flight Log Screen

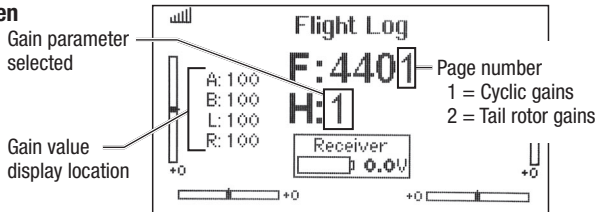

Once you have entered Gain Adjustment Mode, move the cyclic stick forward and backward to select the gain parameter to adjust. Moving the stick backward will select the next parameter. Moving the stick forward will select the previous parameter.

The selected gain parameter is indicated on the Flight Log screen above and by the lean of the swashplate on the roll axis as shown in the table at the right.

Parameter #	Display location	Swash Position	Page #
1	A	100% to the Left	1
2	B	70% to the Left	1
3	L	40% to the Left	1
4	R	10% to the Left	1
5	A	10% to the Right	2
6	B	40% to the Right	2
7	L	70% to the Right	2
8	R	100% to the Right	2

The current gain value for the selected parameter is indicated on the Flight Log screen and by the angle of the swashplate (forward or backward) as shown in the table at the right.

Move the cyclic stick left or right to adjust the gain value. Moving the stick *right* will increase the gain value. Moving the stick *left* will decrease the gain value.

It is always best to adjust one gain at a time. Make small adjustments (5% or less) and test fly the model to evaluate the adjustments that were made.

If you would like to reset the current gain value to the default value of 100%, move and hold the rudder stick full right for 1 second. The swash will level on the pitch axis, indicating a 100% gain setting.

Swash Position	Gain Value
Full backward	0%
50% backward	50%
Level forward and backward	100%
50% forward	150%
Full forward	200%

Saving the Gain Adjustments

1. Lower the throttle stick to the lowest position and release the sticks.
2. Activate the panic recovery function until the swash servos move.
3. Deactivate the panic recovery function to save the gain adjustments.
4. Reconnect the main drive motor to the ESC. Your model is now ready for flight.

Servo Adjustment

Your helicopter was setup at the factory and test flown. The servo adjustment steps are only necessary in special circumstances, such as after a crash or if a servo or linkage is replaced.

Entering Servo Adjustment Mode

1. Lower the throttle stick to the lowest position.
2. Power ON the transmitter.
3. Install the flight battery on the helicopter frame, securing it with the hook and loop strap.
4. Connect the battery connector to the ESC.
5. Place the helicopter on a flat surface and leave it still until the orange receiver LED glows solid, indicating initialization is complete.
6. Set the rate switch on the transmitter to the high rate.

Adjusting the Servo Neutral Position

With the model in Servo Adjustment Mode, the control stick and gyro inputs are disabled and the servos are held in the neutral position. Check the position of the servo arms to see if they are perpendicular to the servos.

- If the arms are perpendicular to the servos, no adjustment is necessary. Exit Servo Adjustment Mode.
- If one or more servo arm is not perpendicular to the servos, continue the servo adjustment process.

While watching the swashplate servos, apply right cyclic and release. One of the servos will jump, indicating which servo is selected. Press right cyclic and release until the servo that needs to be adjusted is selected.

Saving the Servo Adjustments

Before saving your adjustments and exiting servo adjustment mode, verify the swashplate is level and both main rotor blades are at 0 degrees. If they are not, make linkage adjustments as necessary.

1. Lower the throttle stick to the lowest position and release the sticks.
2. Press and hold switch I until the swash servos move.
3. Release switch I to save the servo adjustments.



WARNING: To ensure your safety, always disconnect the motor wires from the ESC before performing the following steps. After you have completed the adjustments, reconnect the motor wires to the ESC before attempting to fly the model.

7. Hold the left stick to the bottom left corner and the right stick to the bottom right corner as shown.

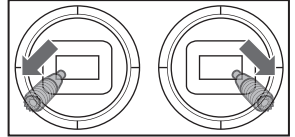

8. Activate the panic recovery function until the swash servos move.
9. Release the sticks and deactivate panic recovery. The model is now in Gain Adjustment Mode.
10. Proceed to Adjusting the Servo Neutral Position to make any desired changes.

Once the servo you wish to adjust is selected, move the cyclic stick forward or backward to adjust the servo neutral position in the desired direction.

If you would like to reset the current servo to the default neutral position, hold the rudder stick full right for 1 second.

The range of adjustment is limited. If you are unable to adjust the servo arm to be perpendicular to the servo, you must reset the servo to the default neutral position, remove the servo arm and place it back onto the servo as close to perpendicular as possible. You may then adjust the servo neutral position using the forward/backward cyclic stick.

4. Disconnect the flight battery from the ESC
5. Reconnect the main drive motor to the ESC. Your model is now ready for flight.

All of the settings are stored internally, so your adjustments will be maintained each time you initialize the model.

Trim Flight

Perform this procedure if the model is not performing well or has been recently rebuilt from a crash.

The trim flight procedure was performed during the factory test flight and only needs to be performed if you notice the model is not returning to level consistently or if the model does not remain still during stationary pirouettes.

The trim flight is used to determine the optimal settings for SAFE® technology during flight.

The trim flight must be performed in calm conditions.

Entering Trim Flight Mode

1. Lower the throttle stick to the lowest position.
2. Center all trims. For the included Spektrum DXe transmitter (RTF only), the trims are centered when you hear a higher pitched beep while pressing the trim button. Move the trim in both directions until you hear the high-pitched beep.
3. Power ON the transmitter.
4. Install the flight battery in the helicopter.
5. Connect the battery connector to the ESC.
6. Place the helicopter on a flat surface and leave it still until the motor beeps twice and the blue ESC LED glows solid, indicating initialization is complete.
7. Place the helicopter where you are going to take off.
8. Move and hold the left stick to the bottom left corner and the right stick to the top left corner as shown.
9. Activate Panic Recovery until the swashplate rotates around once.
10. Release the sticks and deactivate panic recovery.
11. The model is ready for the trim flight.

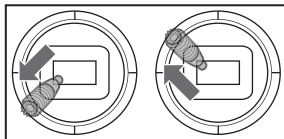

Exiting Trim Flight Mode

1. After landing, lower the throttle stick to the lowest position.
2. Activate Panic Recovery for 2 seconds, or until the swashplate moves, indicating the servo positions and attitude values have been recorded and trim flight mode has been exited.

Flight Test

After performing the trim flight, test-fly the model to evaluate the leveling characteristics.

- The model should return to level flight consistently.
- During takeoff, the model should lift off with minimal corrections.
- During a hover, the control stick should remain close to center. Small corrections are acceptable.

If the model performs poorly or does not level properly after the trim flight, retry the entire trim flight procedure. If the problem persists, inspect the model for damaged components, a bent shaft or anything that may result in increased vibration. The trim flight may not record the correct values due to excessive vibration, flying in wind or the model not staying level. In these cases, shorter trim flights may be necessary. If you are still experiencing problems after several attempts please perform the calibration procedure and try the trim flight procedure again.

Performing the Trim Flight

1. Slowly increase the throttle to lift the model into a stationary hover. Make corrections as necessary to keep the model still. Evaluation does not begin until the throttle stick is over 50% and the sticks are centered. Making corrections will not affect the result but a longer flight may be necessary.
2. Keep the model stationary in a hover for 120 seconds. Sliding and slow movements are okay. The main goal is to keep the rotor disk level.
3. Once you are satisfied with the trim flight, land the model.

Calibration Procedure

If the Blade 230 S V2 is experiencing drift issues after completing the trim flight procedure located at www.bladehelis.com, perform the following calibration. The calibration procedure may also be needed following crash repairs.



WARNING: Before beginning the calibration procedure, disconnect the main motor and tail motor leads to prevent accidental motor startup during calibration.

To perform the calibration procedure:

1. Ensure the surface used for calibration is level.
2. Power on the transmitter and helicopter, allowing them to initialize.
3. Turn Throttle Hold ON.
4. **Ensure the main motor and tail motor leads are disconnected.** Set the flight mode switch to Intermediate Mode (FM1).
5. Using a bubble level as shown below, level the helicopter by placing the Blade 230 S V2 foam blade holder under the tail fin. Use additional items, as necessary, to build up under the tail fin until the tail boom is level.

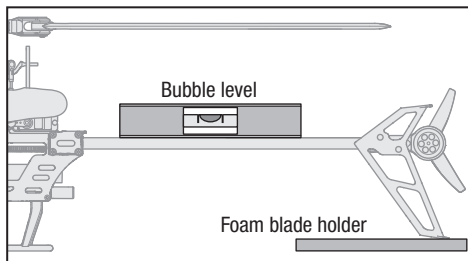

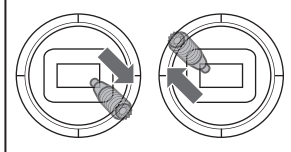
6. Hold the left stick to the bottom right corner, the right stick to the upper left corner and activate the Panic Recovery function until the LED on the receiver flashes once.
- 
7. Release both sticks and deactivate the Panic Recovery function.
 8. The LED on the receiver will remain solid for 1-2 minutes while the calibration takes place. Do not move the helicopter until the calibration is completed. If the LED begins blinking rapidly, an error has occurred. Begin the calibration procedure again, starting with step 1.
 9. After the calibration is successfully completed, the receiver LED will blink slowly (2 seconds on, 2 seconds off).
 10. Power the helicopter off.
 11. Reconnect the main motor and tail motor wires.
 12. Perform the trim flight procedure.
 13. During subsequent flights after the trim flight, the helicopter should return to within 5 degrees of level consistently.

Post-Flight Inspection and Maintenance Checklist

✓		
Ball Links	Make sure the plastic ball link holds the control ball, but is not tight (binding) on the ball. When a link is too loose on the ball, it can separate from the ball during flight and cause a crash. Replace worn ball links before they fail.	
Cleaning	Make sure the battery is not connected before cleaning. Remove dust and debris with a soft brush or a dry, lint-free cloth.	
Bearings	Replace bearings when they become notchy (sticky in places when turning) or draggy.	
Wiring	Make sure the wiring does not contact moving parts. Replace damaged wiring and loose connectors.	
Fasteners	Make sure there are no loose screws, other fasteners or connectors. Do not over-tighten metal screws in plastic parts. Tighten screws so the parts are mated together, then turn the screw only 1/8th of a turn more.	
Rotors	Make sure there is no damage to rotor blades and other parts which move at high speed. Damage to these parts includes cracks, burrs, chips or scratches. Replace damaged parts before flying. Verify both main rotor blades have the correct and equal tension in the blade grips. When the helicopter is held up sideways, the main blades should support their own weight. When the helicopter is shaken lightly, the blades should fall.	
Tail	Inspect the tail rotor for damage and replace if necessary. Verify the tail motor bolts, tail rotor adapter bolts and tail motor mount bolts are properly tightened. Inspect the tail boom for any damage and replace if necessary.	
Mechanics	Inspect the main frame and landing gear for damage and replace if necessary. Check the mainshaft for vertical play and adjust the locking collar if necessary. Verify that the main gear mesh is correct and that no tight spots exist in the 360 degree rotation. Inspect all wires for damage and replace as necessary.	

Troubleshooting Guide

Problem	Possible Cause	Solution
Helicopter control response is inconsistent or requires extra trim to neutralize movement	Aircraft was not initialized properly or a vibration is interfering with the sensor operation	Disconnect the flight battery, center the control trim and re-initialize the helicopter
Helicopter will not respond to throttle	Throttle too high and/or throttle trim is too high	Disconnect the flight battery, place the throttle stick in the lowest position and move the throttle trim to the center position. Connect the flight battery and allow the model to initialize
	Helicopter moved during initialization	Disconnect the flight battery and re-initialize the helicopter while keeping the helicopter from moving
Helicopter has reduced flight time or is under-powered	Flight battery charge is low	Completely recharge the flight battery
	Flight battery is damaged	Replace the flight battery and follow the flight battery instructions
	Flight conditions might be too cold	Make sure the battery is warm (room temperature) before use
LED on receiver flashes rapidly and aircraft will not respond to transmitter (during binding)	Transmitter too near aircraft during binding process	Power off the transmitter. Move the transmitter a larger distance from the aircraft. Disconnect and reconnect the flight battery to the aircraft. Follow the binding instructions
	Bind switch or button was not held while transmitter was powered on	Power off transmitter and repeat bind process
	Aircraft or transmitter is too close to large metal object, wireless source or another transmitter	Move aircraft and transmitter to another location and attempt binding again

Problem	Possible Cause	Solution
LED on the receiver flashes rapidly and the helicopter will not respond to the transmitter (after binding)	The bind plug was not removed from the receiver after binding	Disconnect the flight battery, remove the bind plug from the receiver and reconnect the flight battery.
	Less than a 5-second wait between first powering on the transmitter and connecting the flight battery to the helicopter	Leave the transmitter powered on. Disconnect and reconnect the flight battery to the helicopter
	The helicopter is bound to a different model memory (ModelMatch™ transmitters only)	Select the correct model memory on the transmitter. Disconnect and reconnect the flight battery to the helicopter
	Flight battery or transmitter battery charge is too low	Replace or recharge batteries
	Aircraft or transmitter is too close to large metal object, wireless source or another transmitter	Move aircraft and transmitter to another location and attempt connecting again
Helicopter vibrates or shakes in flight	Damaged rotor blades, spindle or blade grips	Check main rotor blades and blade grips for cracks or chips. Replace damaged parts. Replace bent spindle
Random movements in flight	Vibration	Verify the receiver is properly attached to the helicopter. Inspect mounting tape for damage. Verify that no wires are contacting the receiver. Inspect and balance all rotating components. Verify the main shaft and tail rotor adapter are not damaged or bent. Inspect mechanics for broken or damaged parts and replace as necessary
Tail oscillation/wag or poor performance	Damaged tail rotor, main gear mesh, loose bolts, vibration	Verify that the boom support bolts are tight and the plastic boom support ends are properly adhered to the boom support rods. Inspect the tail rotor for damage. Verify that all bolts on the tail assembly are properly tightened. Verify main gear mesh and ensure no tight spots in the mesh through full rotation. Replace any damaged or worn components
Drift in calm winds	Vibration, damaged linkage, damaged servo	Under normal operation the transmitter trims should not require adjustment and the center positions are memorized during initialization. If you find that trim adjustments are necessary after take off, verify the balance of all rotating components, ensure the linkages are not damaged and make sure the servos are in proper working condition
Drift in wind	Normal	The model will drift with the wind but should remain level in flight. Simply hold the cyclic stick in the necessary position to keep the model stationary. The model must lean into the wind to remain stationary, if the model remains level then it will drift with the wind
Panic Recovery or Return to Level does not level the model	Model was not initialized on a level, still surface	Re-initialize the model on a level and still surface
	Model was not taken off of a level surface	Always lift off from a level surface
Severe vibration	Battery strapped too tightly to the model	Loosen the battery strap
	Rotating component out of balance	Check the main shaft, tail rotor, main rotor blades, main frame and adapter for damage, replace as necessary. Vibration must be minimized for Panic Recovery and Return to Level functions to work properly

Exploded View

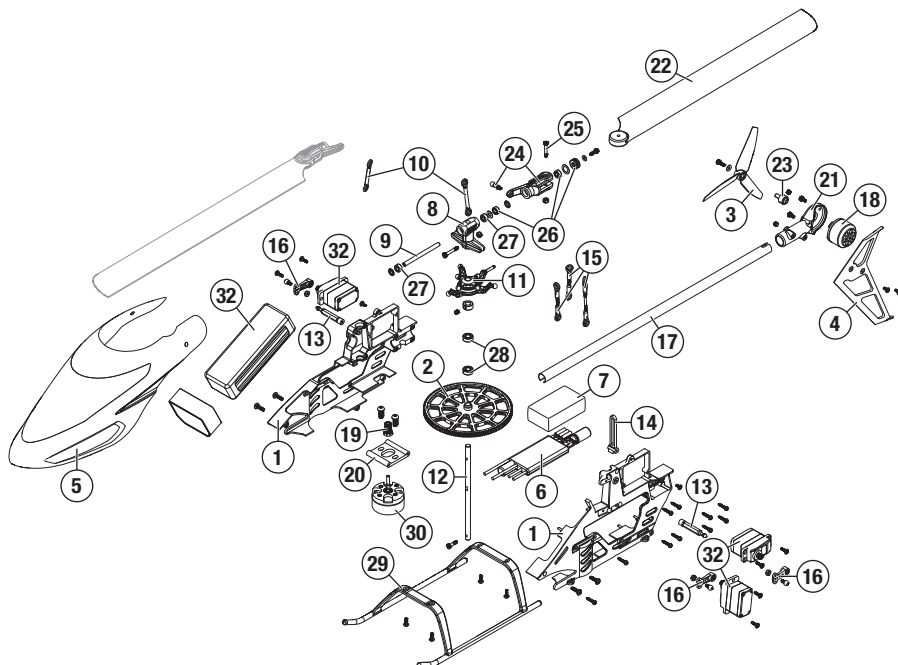

Parts Listings

Part #	Description
1	BLH1401 Main Frame 230 S V2
2	BLH1402 Main Gear 230 S V2
3	BLH1403 Tail Rotor Orange (2) 230 S V2
4	BLH1406 Vertical Fin Orange 230 S V2
5	BLH1407 Canopy 230 S V2
6	BLH1425 Brushless ESC 230 S V2
7	BLH1427 Replacement Receiver 230 S V2
8	BLH1501 Main rotor head Blade 230 S
9	BLH1502 Spindle set Blade 230 S
10	BLH1504 Main rotor head linkage set Blade 230 S
11	BLH1505 Swashplate Blade 230 S
12	BLH1506 Main Shaft Blade 230 S
13	BLH1507 Canopy mounting post Blade 230 S
14	BLH1508 Anti-rotation bracket Blade 230 S
15	BLH1509 Servo pushrod set Blade 230 S
16	BLH1511 Servo arms with linkage balls 230 S

Part #	Description
17	BLH1512 Tail boom Blade 230 S
18	BLH1515 Tail motor 3600kv Blade 230 S
19	BLH1516 Pinion gear 12t
20	BLH1518 Motor mount Blade 230 S
21	BLH1555 Tail motor mount Blade 230 S
22	BLH1577 Main rotor blade set, Orange 230 S
23	BLH2020 Tail Rotor Hub Set: 200 SR X
24	BLH4502 Main Rotor Grips: 300X
25	BLH4503 Main Blade Mounting Screw: 300X
26	BLH4504 Main Grip Bearing Kit: 300X
27	BLH4505 Dampers (4): 300X
28	BLH4515 Bearings 4x8x3 (3): 300X
29	EFLH1502 Landing Gear: BSR
30	EFLH1516 3900kv Brushless Motor: BSR
31	SPMA3032 Foam Gyro Tape
32	SPMSH3050 Sub-Micro Digital Heli Cyclic MG Servo

Optional Parts

Part #	Description
BLH1404	Tail Rotor White (2) 230 S V2
BLH1501A	Aluminum Main Rotor Head: 230 S
BLH1503	Main rotor blade set (white) Blade 230 S
BLH1503C	CF Rotor Blades: 230 S
BLH1513A	Aluminum Tail Case: 230 S
BLH1514	Vertical Tail Fin (white) 230 S
BLH1519A	Aluminum Blade Grips: 230 S

Part #	Description
BLH1554	Complete Night 230 S Upgrade
BLH1574	Canopy fiberglass (green) Blade 230 S
BLH1575	Canopy fiberglass (orange) Blade 230 S
BLH1576	Main rotor blade set (green) Blade 230 S
SPMA3065	AS3X Programming Cable - USB Interface
EFLB8003Sj30	800mAh 3S 11.1v 30C LiPo, JST

Limited Warranty

What this Warranty Covers

Horizon Hobby, LLC, (Horizon) warrants to the original purchaser that the product purchased (the "Product") will be free from defects in materials and workmanship at the date of purchase.

What is Not Covered

This warranty is not transferable and does not cover (i) cosmetic damage, (ii) damage due to acts of God, accident, misuse, abuse, negligence, commercial use, or due to improper use, installation, operation or maintenance, (iii) modification of or to any part of the Product, (iv) attempted service by anyone other than a Horizon Hobby authorized service center, (v) Product not purchased from an authorized Horizon dealer, (vi) Product not compliant with applicable technical regulations, or (vii) use that violates any applicable laws, rules, or regulations.

OTHER THAN THE EXPRESS WARRANTY ABOVE, HORIZON MAKES NO OTHER WARRANTY OR REPRESENTATION, AND HEREBY DISCLAIMS ANY AND ALL IMPLIED WARRANTIES, INCLUDING, WITHOUT LIMITATION, THE IMPLIED WARRANTIES OF NON-INFRINGEMENT, MERCHANTABILITY AND FITNESS FOR A PARTICULAR PURPOSE. THE PURCHASER ACKNOWLEDGES THAT THEY ALONE HAVE DETERMINED THAT THE PRODUCT WILL SUITABLY MEET THE REQUIREMENTS OF THE PURCHASER'S INTENDED USE.

Purchaser's Remedy

Horizon's sole obligation and purchaser's sole and exclusive remedy shall be that Horizon will, at its option, either (i) service, or (ii) replace, any Product determined by Horizon to be defective. Horizon reserves the right to inspect any and all Product(s) involved in a warranty claim. Service or replacement decisions are at the sole discretion of Horizon. Proof of purchase is required for all warranty claims. SERVICE OR REPLACEMENT AS PROVIDED UNDER THIS WARRANTY IS THE PURCHASER'S SOLE AND EXCLUSIVE REMEDY.

Limitation of Liability

HORIZON SHALL NOT BE LIABLE FOR SPECIAL, INDIRECT, INCIDENTAL OR CONSEQUENTIAL DAMAGES, LOSS OF PROFITS OR PRODUCTION OR COMMERCIAL LOSS IN ANY WAY, REGARDLESS OF WHETHER SUCH CLAIM IS BASED IN CONTRACT, WARRANTY, TORT, NEGLIGENCE, STRICT LIABILITY OR ANY OTHER THEORY OF LIABILITY, EVEN IF HORIZON HAS BEEN ADVISED OF THE POSSIBILITY OF SUCH DAMAGES. Further, in no event shall the liability of Horizon exceed the individual price of the Product on which liability is asserted. As Horizon has no control over use, setup, final assembly, modification or misuse, no liability shall be assumed nor accepted for any resulting damage or injury. By the act of use, setup or assembly, the user accepts all resulting liability. If you as the purchaser or user are not prepared

to accept the liability associated with the use of the Product, purchaser is advised to return the Product immediately in new and unused condition to the place of purchase.

Law

These terms are governed by Illinois law (without regard to conflict of law principals). This warranty gives you specific legal rights, and you may also have other rights which vary from state to state. Horizon reserves the right to change or modify this warranty at any time without notice.

WARRANTY SERVICES

Questions, Assistance, and Services

Your local hobby store and/or place of purchase cannot provide warranty support or service. Once assembly, setup or use of the Product has been started, you must contact your local distributor or Horizon directly. This will enable Horizon to better answer your questions and service you in the event that you may need any assistance. For questions or assistance, please visit our website at www.horizonhobby.com, submit a Product Support Inquiry, or call the toll free telephone number referenced in the Warranty and Service Contact Information section to speak with a Product Support representative.

Inspection or Services

If this Product needs to be inspected or serviced and is compliant in the country you live and use the Product in, please use the Horizon Online Service Request submission process found on our website or call Horizon to obtain a Return Merchandise Authorization (RMA) number. Pack the Product securely using a shipping carton. Please note that original boxes may be included, but are not designed to withstand the rigors of shipping without additional protection. Ship via a carrier that provides tracking and insurance for lost or damaged parcels, as Horizon is not responsible for merchandise until it arrives and is accepted at our facility. An Online Service Request is available at http://www.horizonhobby.com/content/_service-center_render-service-center. If you do not have internet access, please contact Horizon Product Support to obtain a RMA number along with instructions for submitting your product for service. When calling Horizon, you will be asked to provide your complete name, street address, email address and phone number where you can be reached during business hours. When sending product into Horizon, please include your RMA number, a list of the included items, and a brief summary of the problem. A copy of your original sales receipt must be included for warranty consideration. Be sure your name, address, and RMA number are clearly written on the outside of the shipping carton.

NOTICE: Do not ship Li-Po batteries to Horizon. If you have any issue with a Li-Po battery, please contact the appropriate Horizon Product Support office.

Warranty Requirements

For Warranty consideration, you must include your original sales receipt verifying the proof-of-purchase date. Provided warranty conditions have been met, your Product will be serviced or replaced free of charge. Service or replacement decisions are at the sole discretion of Horizon.

Non-Warranty Service

Should your service not be covered by warranty, service will be completed and payment will be required without notification or estimate of the expense unless the expense exceeds 50% of the retail purchase cost.

By submitting the item for service you are agreeing to payment of the service without notification. Service estimates are available upon request. You must include this request with your item submitted for service. Non-warranty service estimates will be billed a minimum of ½ hour of labor. In addition

you will be billed for return freight. Horizon accepts money orders and cashier's checks, as well as Visa, MasterCard, American Express, and Discover cards. By submitting any item to Horizon for service, you are agreeing to Horizon's Terms and Conditions found on our website http://www.horizonhobby.com/content/_service-center_render-service-center.

ATTENTION: Horizon service is limited to Product compliant in the country of use and ownership. If received, a non-compliant Product will not be serviced. Further, the sender will be responsible for arranging return shipment of the un-serviced Product, through a carrier of the sender's choice and at the sender's expense. Horizon will hold non-compliant Product for a period of 60 days from notification, after which it will be discarded.

10/15

Warranty and Service Contact Information

Country of Purchase	Horizon Hobby	Contact Information	Address
United States of America	Horizon Service Center (Repairs and Repair Requests)	servicecenter.horizonhobby.com/RequestForm/	2904 Research Rd Champaign, Illinois, 61822 USA
	Horizon Product Support (Product Technical Assistance)	productsupport@horizonhobby.com 877-504-0233	
	Sales	websales@horizonhobby.com 800-338-4639	
European Union	Horizon Technischer Service	service@horizonhobby.eu	Hanskampring 9 D 22885 Barsbüttel, Germany
	Sales: Horizon Hobby GmbH	+49 (0) 4121 2655 100	

FCC Information

BLH1400 contains FCC ID: BRWDASRX15, BRWDXE

BLH1450 contains FCC ID: BRWDASRX15

This equipment has been tested and found to comply with the limits for Part 15 of the FCC rules. These limits are designed to provide reasonable protection against harmful interference in a residential installation. This equipment generates uses and can radiate radio frequency energy and, if not installed and used in accordance with the instructions, may cause harmful interference to radio communications.

However, there is no guarantee that interference will not occur in a particular installation. If this equipment does cause harmful interference to radio or television reception, which can be determined by turning the equipment off and on, the user is encouraged to try to correct the interference by one or more of the following measures:

Reorient or relocate the receiving antenna.

- Increase the separation between the equipment and receiver.
- Connect the equipment to an outlet on a circuit different from that to which the receiver is connected.
- Consult the dealer or an experienced radio/TV technician for help.

This device complies with part 15 of the FCC rules.

Operation is subject to the following two conditions:

(1) This device may not cause harmful interference, and (2) this device must accept any interference received, including interference that may cause undesired operation.

NOTICE: Modifications to this product will void the user's authority to operate this equipment.

FCC Information

This device complies with part 15 of the FCC rules. Operation is subject to the following two conditions:
(1) This device may not cause harmful interference, and (2) this device must accept any interference received, including interference that may cause undesired operation.



CAUTION: Changes or modifications not expressly approved by the party responsible for compliance could void the user's authority to operate the equipment.

This product contains a radio transmitter with wireless technology which has been tested and found to be compliant with the applicable regulations governing a radio transmitter in the 2.400GHz to 2.4835GHz frequency range.

Antenna Separation Distance

When operating your Spektrum transmitter, please be sure to maintain a separation distance of at least 5 cm between your body (excluding fingers, hands, wrists, ankles and feet) and the antenna to meet RF exposure safety requirements as determined by FCC regulations.

The following illustrations show the approximate 5 cm RF exposure area and typical hand placement when operating your Spektrum transmitter.

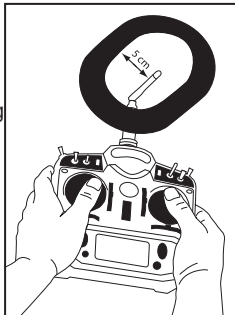

IC Information

BLH1400 contains IC: 6157A-AMRX15, 6157A-DXe

BLH1450 contains IC: 6157A-AMRX15

This device complies with Industry Canada licence-exempt RSS standard(s). Operation is subject to the following two conditions: (1) this device may not cause interference, and

(2) this device must accept any interference, including interference that may cause undesired operation of the device."

Compliance Information for the European Union



EU Compliance Statement:

Horizon Hobby, LLC hereby declares that this product is in compliance with the essential requirements and other relevant provisions of the RED, EMC, and LVD Directives.

A copy of the EU Declaration of Conformity is available online at: <http://www.horizonhobby.com/content/support-render-compliance>.

Instructions for disposal of WEEE by users in the European Union



This product must not be disposed of with other waste. Instead, it is the user's responsibility to dispose of their waste equipment by handing it over to a designated collections point for the recycling of waste electrical and electronic equipment. The separate collection and recycling of your

waste equipment at the time of disposal will help to conserve natural resources and make sure that it is recycled in a manner that protects human health and the environment. For more information about where you can drop off your waste equipment for recycling, please contact your local city office, your household waste disposal service or where you purchased the product.



E328



BLADE®

©2020 Horizon Hobby, LLC

Blade, E-flite, Bind-N-Fly, the BNF logo, DSM, DSM2, DSMX, AS3X, SAFE, the SAFE logo and ModelMatch are trademarks or registered trademarks of Horizon Hobby, LLC.

The Spektrum trademark is used with permission of Bachmann Industries, Inc.

Futaba is a registered trademark of Futaba Denshi Kogyo Kabushiki Kaisha Corporation of Japan. All other trademarks, service marks and logos are property of their respective owners.

US D774,933

Created 02/20 56791.1 BLH1400/BLH1450