

HORIZON[®]
H O B B Y

Eflite[®]
ADVANCING ELECTRIC FLIGHT

UMX[™] Timber[™]

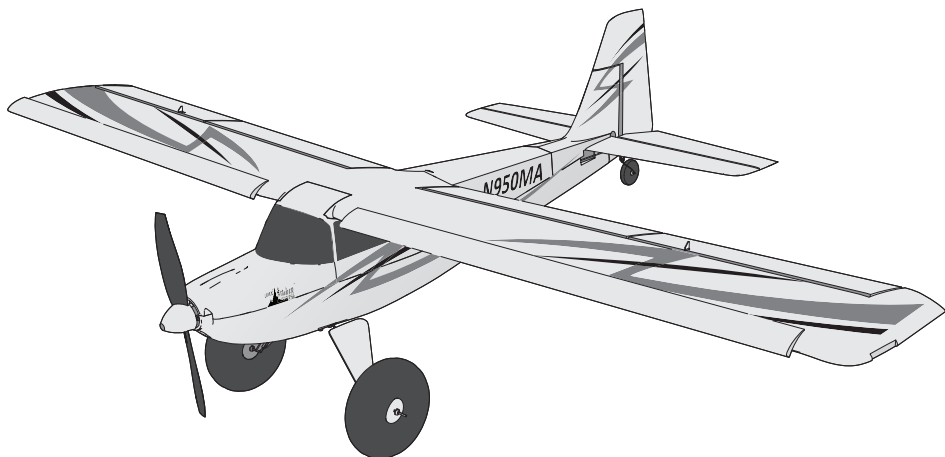

Instruction Manual
Bedienungsanleitung
Manuel d'utilisation
Manuale di Istruzioni

AS3X[®] 

Bind-N-Fly[®]
BASIC

NOTICE

All instructions, warranties and other collateral documents are subject to change at the sole discretion of Horizon Hobby, LLC. For up-to-date product literature, visit www.horizonhobby.com and click on the support tab for this product.

Meaning of Special Language:

The following terms are used throughout the product literature to indicate various levels of potential harm when operating this product:

WARNING: Procedures, which if not properly followed, create the probability of property damage, collateral damage, and serious injury OR create a high probability of superficial injury.

CAUTION: Procedures, which if not properly followed, create the probability of physical property damage AND a possibility of serious injury.

NOTICE: Procedures, which if not properly followed, create a possibility of physical property damage AND little or no possibility of injury.



WARNING: Read the ENTIRE instruction manual to become familiar with the features of the product before operating. Failure to operate the product correctly can result in damage to the product, personal property and cause serious injury.

This is a sophisticated hobby product. It must be operated with caution and common sense and requires some basic mechanical ability. Failure to operate this product in a safe and responsible manner could result in injury or damage to the product or other property. This product is not intended for use by children without direct adult supervision. Do not use with incompatible components or alter this product in any way outside of the instructions provided by Horizon Hobby, LLC. This manual contains instructions for safety, operation and maintenance. It is essential to read and follow all the instructions and warnings in the manual, prior to assembly, setup or use, in order to operate correctly and avoid damage or serious injury.

Age Recommendation: Not for children under 14 years. This is not a toy.

Safety Precautions and Warnings

- Always keep a safe distance in all directions around your model to avoid collisions or injury. This model is controlled by a radio signal subject to interference from many sources outside your control. Interference can cause momentary loss of control.
- Always operate your model in open spaces away from full-size vehicles, traffic and people.
- Always carefully follow the directions and warnings for this and any optional support equipment (chargers, rechargeable battery packs, etc.).
- Always keep all chemicals, small parts and anything electrical out of the reach of children.
- Always avoid water exposure to all equipment not specifically designed and protected for this purpose. Moisture causes damage to electronics.
- Never place any portion of the model in your mouth as it could cause serious injury or even death.
- Never operate your model with low transmitter batteries.
- Always keep aircraft in sight and under control.
- Always use fully charged batteries.
- Always keep the transmitter powered on while aircraft is powered.
- Always remove batteries before disassembly.
- Always keep moving parts clean.
- Always keep parts dry.
- Always let parts cool after use before touching.
- Always remove batteries after use.
- Always ensure failsafe is properly set before flying.
- Never operate aircraft with damaged wiring.
- Never touch moving parts.

Specifications

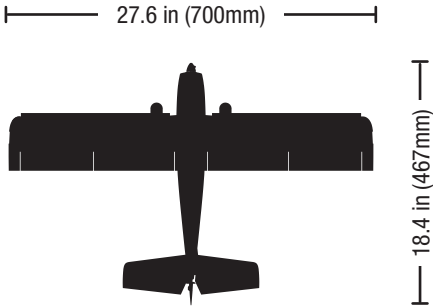

Wing Area: 119.0 sq In
 (7.7 sq Dm)

4.3oz
 (121g)

Installed



Motor: BL180 Brushless Outrunner
3,000Kv (EFLUM180BLB)



Receiver : DSM2® 6 Ch. UM AS3X® RX
BL-ESC (EFLU4864)



(2) 2.3-Gram Performance Linear Long
Throw Offset Servo (SPMSA2030L0)

Required to Complete



Battery: 280mAh 2S 7.4V 30C Li-Po,
(EFLB2802S30)



Battery Charger:
Celectra™ 2S 7.4V DC Li-Po Charger
(EFLUC1007)



Recommended Transmitter:
Full range Spektrum™ DSM2®/DSMX®
with dual-rates (DXe and up)

Preflight Checklist

✓	
	1. Charge flight battery.
	2. Install flight battery in aircraft (once it has been fully charged).
	3. Bind aircraft to transmitter.
	4. Make sure linkages move freely.
	5. Perform Control Direction Test with transmitter.
	6. Perform AS3X control Direction Test with aircraft.

✓	
	7. Set dual rates.
	8. Adjust center of gravity.
	9. Perform a radio system Range Check.
	10. Find a safe and open area.
	11. Plan flight for flying field conditions.
	12. Set flight timer for 5 minutes for first flight.

To register your product online, go to www.e-fliterc.com

Transmitter and Receiver Binding

Binding is the process of programming the receiver to recognize the GUID (Globally Unique Identifier) code of a single specific transmitter. You need to 'bind' your chosen Spektrum™ DSM2/DSMX technology equipped aircraft transmitter to the receiver for proper operation.

Any full range Spektrum DSM2/DSMX transmitter can bind to the DSM2/DSMX receiver. Please visit www.bindnfly.com for a complete list of compatible transmitters.

✓ Binding Procedure	
	CAUTION: When using a Futaba transmitter with a Spektrum DSM® module, you must reverse the throttle channel and rebind. Refer to your Spektrum module manual for binding and failsafe instructions. Refer to your Futaba transmitter manual for instructions on reversing the throttle channel.
	1. Refer to your transmitter's unique instructions for binding to a receiver (location of transmitter's Bind control).
	2. Make sure the flight battery is disconnected from the aircraft.
	3. Power off your transmitter.
	4. Set the aircraft upright on its wheels and connect the flight battery in the aircraft. The receiver LED will begin to flash rapidly (typically after 5 seconds)
	5. Make sure the transmitter controls are neutral and the throttle and throttle trim are in low position.
	6. Put your transmitter into bind mode. Refer to your transmitter's manual for binding button or switch instructions.
	7. After 5 to 10 seconds, the receiver status LED will turn solid, indicating that the receiver is bound to the transmitter. If the LED does not turn solid, refer to the Troubleshooting Guide at the back of the manual.

For subsequent flights, power ON the transmitter for 5 seconds before connecting the flight battery.

SAFE® Select Technology

The evolutionary SAFE® Select technology can offer an extra level of protection so you can perform the first flight with confidence. No complex transmitter programming is required. **Just simply flip your GEAR switch to position 1 (Channel 5) to make the SAFE Select system active.** Flip the Gear switch back to turn OFF SAFE Select and fly with just the assistance of AS3X.

When activated, bank and pitch limitations keep you from over-controlling and automatic self-leveling makes recovery from risky or confusing attitudes as simple as releasing the sticks. In fact, with the aileron, elevator and rudder sticks in the neutral position, SAFE Select will automatically keep the airplane in a straight and level attitude.

Transmitter Setup

To obtain the best flight performance, we recommend using a DSM2®/DSMX® transmitter capable of Dual Rates. Before binding, ensure that you are starting with a blank acro model in your transmitter.

IMPORTANT: After you set up your model, always rebind the transmitter and receiver to set the desired failsafe positions.

Program Your Transmitter

1. Start with a new ACRO Model.
2. Set Aircraft Type: Wing >1Ail 1Flap
: Tail > Normal
3. Leave all settings at their default values.

The Gear Switch (ch 5) will control the Safe mode function.

- Switch position 0 = SAFE Mode
- Switch position 1 = AS3X Mode

Computerized Transmitter Setup (DX6e, DX6 G2, DX7 G2, DX8 G2, DX9, DX18 and DX20)	
Start all transmitter programming with a blank ACRO model (do a model reset), then name the model.	
Set Servo Travel to:	100%
F-Mode Setup	
Switch 1	Inhibit
Switch 2	Inhibit
Channel Assign	
Channel Input Config	
1 Throttle	
2 Aileron	
3 Elevator	
4 Rudder	
5 Gear	SAFE/AS3X
6 Aux 1	
Frame Rate	
22mz	
DSMX	
Funtion List	
Timer	
Mode	Count Down
Time	6:00
Start	Throttle Out
Over	25%
One Time	Inhibit

Dual Rates and Expos

The suggested settings shown here are the recommended starting settings. Adjust according to the individual preferences after the initial flight.

NOTICE: Do not set your transmitter travel adjust over 100%. If the TRAVEL ADJUST is set over 100%, it will not result in more control movement, it will overdrive the servo and cause damage.

It is normal for linear servos to make significant noise. The noise is not an indication of a faulty servo.

Tip: For the first flight, fly the model in low rate.

	Dual Rates	
	Low	High
Aileron	70%	100%
Elevator	70%	100%
Rudder	70%	100%

ESC/Receiver Arming, Battery Installation and Center of Gravity

CAUTION: Always keep hands away from the propeller. When armed, the motor will turn the propeller in response to any throttle movement.

Arming the ESC/receiver also occurs after binding as previously described, but subsequent connection of a flight battery requires the following steps.

AS3X

The AS3X® system will not activate until the throttle stick or trim is increased for the first time. Once active, the control surfaces may move rapidly and noisily on the aircraft. This is normal. AS3X technology will remain active until the battery is disconnected.

1. Remove the battery hatch from the fuselage.
2. Install the flight battery in the center of battery tray. Ensure the battery is secured by the hook and loop strip.

Center of Gravity (CG)

Measure back **28mm** from the leading edge of the top wing, where the wing meets the fuselage and place a mark. Balance the airplane on this CG mark. The easiest way to achieve CG is to balance the aircraft upright.

3. Lower the throttle and throttle trim to the lowest settings on your transmitter. Power on your transmitter, then wait 5 seconds.
4. Connect the battery to the ESC, noting proper polarity. Keep the aircraft upright (on its gear) and immobile and away from wind for 5 seconds to allow the AS3X system to initialize. A series of tones and a continuous LED indicates a successful connection.

CAUTION: Always disconnect the Li-Po battery from the ESC when not flying to eliminate power supplied to the motor. The ESC does not have an arming switch and will respond to any transmitter input when a signal is present.

CAUTION: Always disconnect the Li-Po battery from the ESC when not flying to avoid over-discharging the battery. Batteries discharged to a voltage lower than the lowest approved voltage may become damaged, resulting in loss of performance and potential fire when batteries are charged.

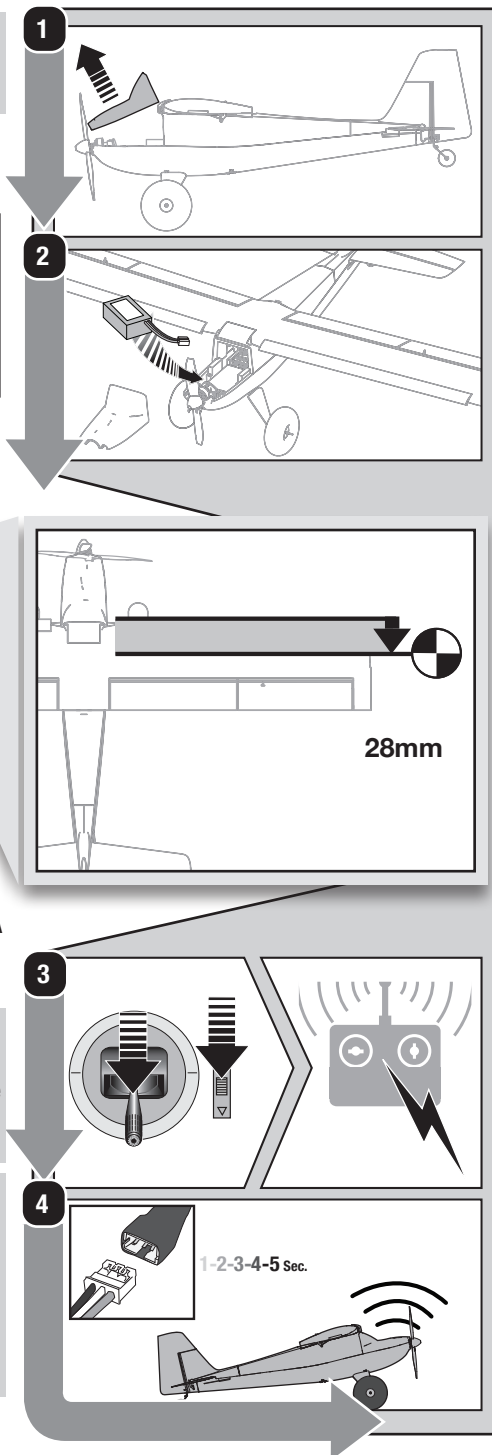





Control Direction Tests

Traditional Control Direction Test

You should bind your aircraft and transmitter before doing these tests. Move the controls on the transmitter to make sure the aircraft control surfaces move correctly and in the proper direction. Make sure the tail linkages move freely and that paint or decals are not adhered to them.

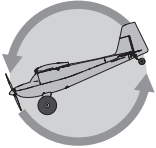
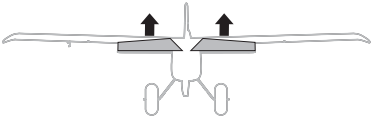
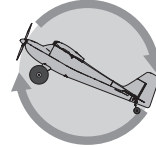
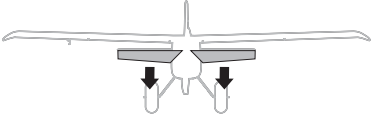
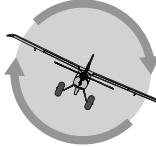
AS3X® Control Direction Test

This test ensures that the AS3X® control system is functioning properly.

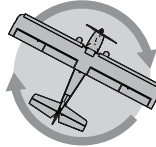
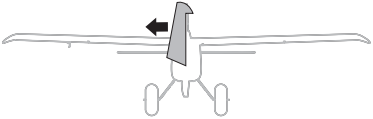
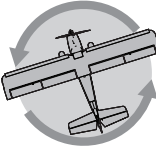
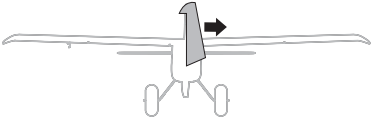
		Aircraft movement	AS3X Reaction
<ol style="list-style-type: none"> 1. Advance the throttle above 25% to activate the AS3X system. 2. Fully lower the throttle. 3. Move the entire aircraft as shown and ensure the control surfaces move in the direction indicated in the graphic. If the control surfaces do not respond as shown, do not fly the aircraft. Refer to the receiver manual for more information. 	Elevator		
			
<p>Once the AS3X system is active, control surfaces may move rapidly. This is normal. AS3X is active until the battery is disconnected.</p>	Aileron		
			
	Rudder		
			

Control Centering

Before your first flight make sure the aircraft's control surfaces are centered.

1. Power on the transmitter and then the aircraft.
2. Set all transmitter trims and sub-trims to zero.
3. Check the control surfaces to make sure they are centered.
4. If centering is required, use a pair of pliers to carefully bend the metal linkage (see illustration).

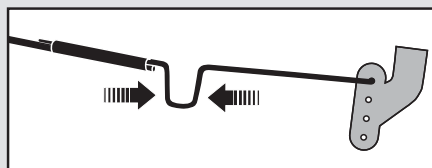

Make the U-shape narrower to make the connector shorter. Make the U-shape wider to make the linkage longer.

In flight trimming may be required

During your first flight, the aircraft should fly straight and level. Use your transmitter trims to fine-tune the aircraft's flight path until it has been corrected. Any transmitter trim that requires 4 or more clicks of trim (per channel), should be mechanically centered. Note the control surface's position and return the transmitter trim to zero. Adjust the linkages mechanically so that the control surfaces are in the flight trimmed position.

Control Horn Settings

The illustration shows linkage positions chosen for the best aerobatic response. Linkage connections on the control horns directly affect aircraft response.

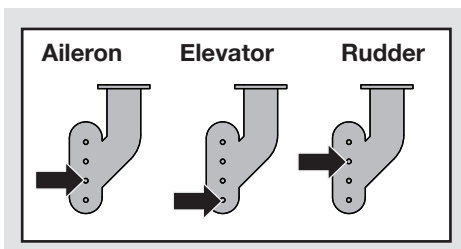

Low Voltage CutOff

LVC is a feature built into your ESC to protect the battery from over-discharge. When the battery charge becomes too low, LVC limits power supplied to the motor. When you hear the motor power pulse, land the aircraft immediately and recharge the flight battery.

NOTICE: Do not rely on LVC to determine when to land your aircraft. Set a flight timer to the recommended flight time. Repeated flying to LVC will damage the battery.

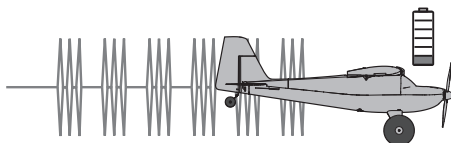

Flying Tips and Repairs

We recommend flying your aircraft outside in calm conditions. Always avoid flying near houses, trees, wires and buildings. You should also be careful to avoid flying in areas where there are many people, such as busy parks, schoolyards or soccer fields. Consult local laws and ordinances before choosing a location to fly your aircraft.

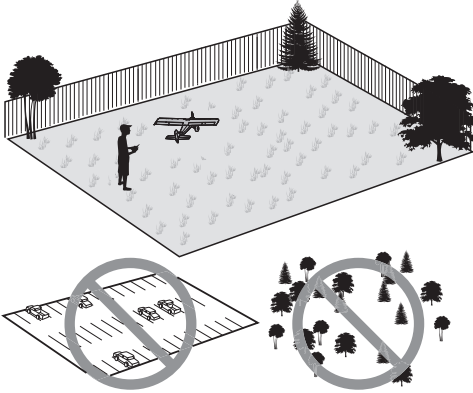

Takeoff

Place the aircraft in position for takeoff (facing into the wind if flying outdoors). Set dual rates to low position and gradually increase the throttle to $\frac{3}{4}$ to full and steer with the rudder. Pull back gently on the elevator and climb to check trim. Once the trim is adjusted, begin exploring the flight envelope of the aircraft.

Landing

Land into the wind. This is very important for this model. Fly the aircraft to approximately 6 inches (15cm) or less above the runway, using a small amount of throttle for the entire descent. Keep the throttle on until the aircraft is ready to flare.

During flare, keep the wings level and the airplane pointed into the wind. Gently lower the throttle while pulling back on the elevator to bring the aircraft down on all three wheels.

Post Flight Checklist

✓	
1.	Disconnect the flight battery from the ESC (Required for safety and battery life).
2.	Power OFF the transmitter.
3.	Remove the flight battery from the aircraft.
4.	Recharge the flight battery.

Failure to lower the throttle stick and trim to the lowest possible positions during a crash could result in damage to the ESC in the receiver unit, which may require replacement.

Over Current Protection (OCP)

This aircraft is equipped with Over Current Protection (OCP). This feature protects the ESC from overheating. OCP stops the motor when the transmitter throttle is set too high and the propeller cannot turn. The OCP will only activate when the throttle stick is positioned just above $\frac{1}{2}$ throttle. After the ESC stops the motor, fully lower the throttle to re-arm the ESC.

NOTICE: Crash damage is not covered under the warranty.

Repairs

Repair the aircraft using foam-compatible CA (cyanoacrylate adhesive) or clear tape. **Only use foam-compatible CA**, as other types of glue can damage the foam. When parts are not repairable, see the Replacement Parts List for ordering by item number.

For a listing of all replacement and optional parts, refer to the list at the end of this manual.

NOTICE: Use of foam-compatible CA accelerant on your aircraft can damage paint. DO NOT handle the aircraft until the accelerant fully dries.

NOTICE: When you are finished flying, never leave the aircraft in direct sunlight or in a hot, enclosed area such as a car. Doing so can damage the foam.

✓	
5.	Store the flight battery apart from the aircraft and monitor the battery charge.
6.	Make note of the flight conditions and flight plan results, planning for future flights.

CAUTION:
Always decrease throttle at propeller strike.

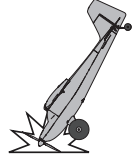

Power Components Service

Disassembly

CAUTION: DO NOT handle the propeller while the flight battery is connected to the ESC. Personal injury could result.

Propeller

1. Carefully remove the screw (A) and propeller (B) from the motor shaft.

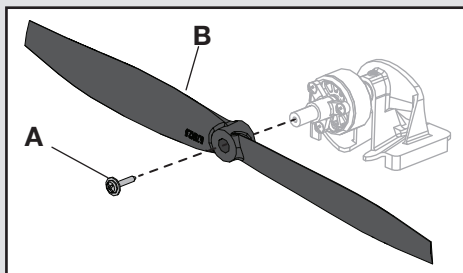

Motor

1. Remove the battery hatch by gripping the front of the hatch, then pulling it up and away from the fuselage.
2. Disconnect the motor wire connector from the ESC/receiver connector.
3. Remove the screw (C) and motor (D) from the motor mount.
4. Remove 3 screws (E) and the prop adapter (F) from the motor. The motor magnet may attract screws to the motor.

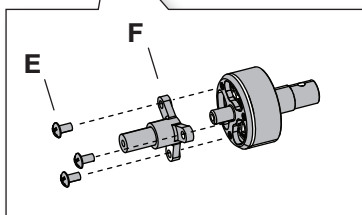
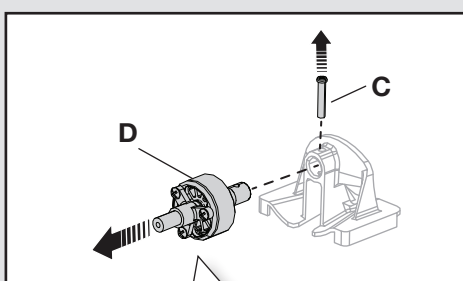

Assembly

Assemble in reverse order.

- Connect the motor wire connector to the ESC/receiver.
- The propeller size numbers (5.75x2.5) must face out from the motor for correct propeller operation.
- Ensure the propeller adapter and motor mount are fully connected to the motor.

Slat Installation (Optional)

Required Adhesives:



Foam Safe CA

1. Apply a small drop of foam safe CA to each mount.
2. Carefully mount the slat onto the wing with the rounded edge facing forward.

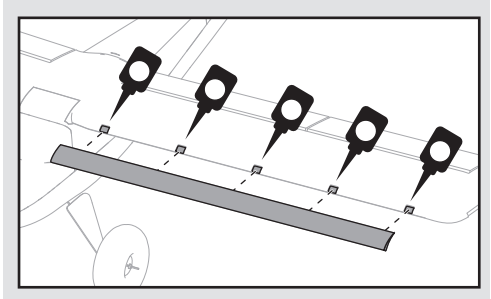

Float installation (Optional)

Landing Gear Removal

1. Carefully place the aircraft on its back.
2. Remove the 4 screws and 2 plates securing the landing gear.
3. Remove the other 4 screws and 2 plates for the rear float mount. Save all screws and plates for the float installation.
4. Remove the landing gear.

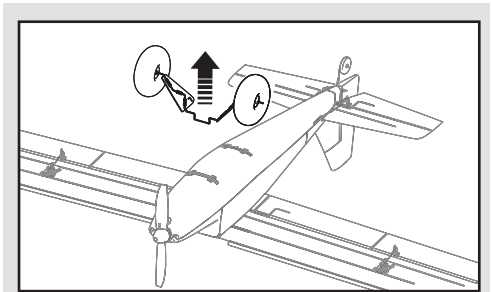
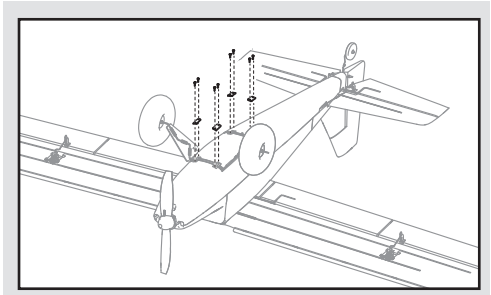

Float Installation

1. Install the included rear float wire onto the floats.
2. Install the floats as shown.
3. Install the 6 screws and 4 plates removed above.

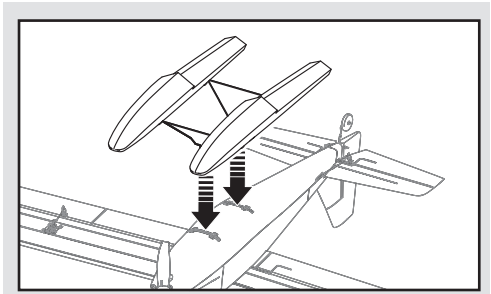

Troubleshooting Guide

AS3X		
Problem	Possible Cause	Solution
Control surfaces not at neutral position when transmitter controls are at neutral	Control surfaces may not have been mechanically centered from factory	Center control surfaces mechanically by adjusting the U-bends on control linkages
	Aircraft was not kept immobile for 5 seconds after battery was plugged in	Keep the aircraft immobile for 5 seconds after plugging in the battery
Model flies inconsistently from flight to flight	Aircraft was not kept immobile for 5 seconds after battery was plugged in	Keep the aircraft immobile for 5 seconds after plugging in the battery
	Trims are moved too far from neutral position	Neutralize trims and mechanically adjust linkages to center control surfaces
Controls oscillate in flight, (model rapidly jumps or moves)	Propeller, spinner or motor is unbalanced, causing excessive vibration	Balance parts or replace it if damaged
	Nut on prop shaft is too loose, causing excessive vibration	Tighten the prop shaft nut 1/2 turn

Problem	Possible Cause	Solution
Aircraft will not respond to throttle but responds to other controls	Throttle stick and/or throttle trim too high	Reset controls with throttle stick and throttle trim at lowest setting
	Throttle channel is reversed	Reverse throttle channel on transmitter
	Motor disconnected from receiver	Open fuselage and make sure motor is connected to the receiver
Extra propeller noise or extra vibration	Propeller, spinner or motor is unbalanced, causing excessive vibration	Balance parts or replace it if damaged
	Prop screw is too loose	Tighten the prop screw
Reduced flight time or aircraft underpowered	Flight battery charge is low	Completely recharge flight battery
	Propeller installed backwards	Install propeller with numbers facing forward
	Flight battery damaged or old.	Replace flight battery and follow flight battery instructions
	Flight conditions may be too cold	Make sure battery is warm before use
	Battery capacity too low for flight conditions	Replace battery or use a larger capacity battery
LED on receiver flashes and aircraft will not bind to transmitter (during binding)	Transmitter too near aircraft during binding process	Power off transmitter, move transmitter a larger distance from aircraft, disconnect and reconnect flight battery to aircraft and follow binding instructions
	Bind switch or button not held long enough during bind process	Power off transmitter and repeat bind process. Hold transmitter bind button or switch until receiver is bound
	Aircraft or transmitter is too close to large metal object, wireless source or another transmitter	Move aircraft and transmitter to another location and attempt binding again

Troubleshooting Guide (Continued)

Problem	Possible Cause	Solution
LED on receiver flashes rapidly and aircraft will not respond to transmitter (after binding)	Less than a 5-second wait between first powering on transmitter and connecting flight battery to aircraft	Leaving transmitter on, disconnect and reconnect flight battery to aircraft
	Aircraft bound to different model memory (ModelMatch™ radios only)	Select correct model memory on transmitter and disconnect and reconnect flight battery to aircraft
	Flight battery/transmitter battery charge is too low	Replace/recharge batteries
	Transmitter may not be compatible with Spektrum DSM2/DSMX technology	Use a genuine Spektrum DSM2/DSMX transmitter
	Aircraft or transmitter is too close to large metal object, wireless source or another transmitter	Move aircraft and transmitter to another location and attempt linking again
Control surface does not move	Control surface, control horn, linkage or servo damage	Replace or repair damaged parts and adjust controls
	Wires damaged or connections loose	Do a check of wires and connections, connect or replace as needed
	Flight battery charge is low	Fully recharge flight battery
	Control linkage does not move freely	Make sure control linkage moves freely
Controls reversed	Transmitter settings reversed	Adjust controls on transmitter appropriately
Motor loses power	Damage to motor or power components	Do a check of motor and power components for damage (replace as needed)
Motor power quickly decreases and increases then motor loses power	Battery power is down to the point of receiver/ESC Low Voltage Cutoff (LVC)	Recharge flight battery or replace battery that is no longer performing
Motor/ESC is not armed after landing	Over Current Protection (OCP) stops the motor when the transmitter throttle is set high and the propeller cannot turn	Fully lower throttle and throttle trim to arm ESC
Servo locks or freezes at full travel	Travel adjust value is set above 100%, overdriving the servo	Set Travel adjust to 100% or less and/or set sub-trims to Zero and adjust linkages mechanically

Limited Warranty

What this Warranty Covers

Horizon Hobby, LLC, (Horizon) warrants to the original purchaser that the product purchased (the "Product") will be free from defects in materials and workmanship at the date of purchase.

What is Not Covered

This warranty is not transferable and does not cover (i) cosmetic damage, (ii) damage due to acts of God, accident, misuse, abuse, negligence, commercial use, or due to improper use, installation, operation or maintenance, (iii) modification of or to any part of the Product, (iv) attempted service by anyone other than a Horizon Hobby authorized service center, (v) Product not purchased from an authorized Horizon dealer, or (vi) Product not compliant with applicable technical regulations, or (vii) use that violates any applicable laws, rules, or regulations.

OTHER THAN THE EXPRESS WARRANTY ABOVE, HORIZON MAKES NO OTHER WARRANTY OR REPRESENTATION, AND HEREBY DISCLAIMS ANY AND ALL IMPLIED WARRANTIES, INCLUDING, WITHOUT LIMITATION, THE IMPLIED WARRANTIES OF NON-INFRINGEMENT, MERCHANTABILITY AND FITNESS FOR A PARTICULAR PURPOSE. THE PURCHASER ACKNOWLEDGES THAT THEY ALONE HAVE DETERMINED THAT THE PRODUCT WILL SUITABLY MEET THE REQUIREMENTS OF THE PURCHASER'S INTENDED USE.

Purchaser's Remedy

Horizon's sole obligation and purchaser's sole and exclusive remedy shall be that Horizon will, at its option, either (i) service, or (ii) replace, any Product determined by Horizon to be defective.

Horizon reserves the right to inspect any and all Product(s) involved in a warranty claim. Service or replacement decisions are at the sole discretion of Horizon. Proof of purchase is required for all warranty claims. **SERVICE OR REPLACEMENT AS PROVIDED UNDER THIS WARRANTY IS THE PURCHASER'S SOLE AND EXCLUSIVE REMEDY.**

Limitation of Liability

HORIZON SHALL NOT BE LIABLE FOR SPECIAL, INDIRECT, INCIDENTAL OR CONSEQUENTIAL DAMAGES, LOSS OF PROFITS OR PRODUCTION OR COMMERCIAL LOSS IN ANY WAY, REGARDLESS OF WHETHER SUCH CLAIM IS BASED IN CONTRACT, WARRANTY, TORT, NEGLIGENCE, STRICT LIABILITY OR ANY OTHER THEORY OF LIABILITY, EVEN IF HORIZON HAS BEEN ADVISED OF THE POSSIBILITY OF SUCH DAMAGES. Further, in no event shall the liability of Horizon exceed the individual price of the Product on which liability is asserted. As Horizon has no control over use, setup, final assembly, modification or misuse, no liability shall be assumed nor accepted for any resulting damage or injury. By the act of use, setup or assembly, the user accepts all resulting liability. If you as the purchaser or user are not prepared to accept the liability associated with the use of the Product, purchaser is advised to return the Product immediately in new and unused condition to the place of purchase.

Law

These terms are governed by Illinois law (without regard to conflict of law principals). This warranty gives you specific legal rights, and you may also have other rights which vary from state to state. Horizon reserves the right to change or modify this warranty at any time without notice.

WARRANTY SERVICES

Questions, Assistance, and Services

Your local hobby store and/or place of purchase cannot provide warranty support or service. Once assembly, setup or use of the Product has been started, you must contact your local distributor or Horizon directly. This will enable Horizon to better answer your questions and service you in the event that you may need any assistance. For questions or assistance, please visit our website at www.horizonhobby.com, submit a Product Support Inquiry, or call the toll free telephone number referenced in the Warranty and Service Contact Information section to speak with a Product Support representative.

Inspection or Services

If this Product needs to be inspected or serviced and is compliant in the country you live and use the Product in, please use the Horizon Online Service Request submission process found on our website or call Horizon to obtain a Return Merchandise Authorization (RMA) number. Pack the Product securely using a shipping carton. Please note that original boxes may be included, but are not designed to withstand the rigors of shipping

without additional protection. Ship via a carrier that provides tracking and insurance for lost or damaged parcels, as Horizon is not responsible for merchandise until it arrives and is accepted at our facility. An Online Service Request is available at http://www.horizonhobby.com/content/_service-center_render-service-center. If you do not have internet access, please contact Horizon Product Support to obtain a RMA number along with instructions for submitting your product for service. When calling Horizon, you will be asked to provide your complete name, street address, email address and phone number where you can be reached during business hours. When sending product into Horizon, please include your RMA number, a list of the included items, and a brief summary of the problem. A copy of your original sales receipt must be included for warranty consideration. Be sure your name, address, and RMA number are clearly written on the outside of the shipping carton.

NOTICE: Do not ship LiPo batteries to Horizon. If you have any issue with a LiPo battery, please contact the appropriate Horizon Product Support office.

Warranty Requirements

For Warranty consideration, you must include your original sales receipt verifying the proof-of-purchase date. Provided warranty conditions have been met, your Product will be serviced or replaced free of charge. Service or replacement decisions are at the sole discretion of Horizon.

Non-Warranty Service

Should your service not be covered by warranty, service will be completed and payment will be required without notification or estimate of the expense unless the expense exceeds 50% of the retail purchase cost. By submitting the item for service you are agreeing to payment of the service without notification. Service estimates are available upon request. You must include this request with your item submitted for service. Non-warranty service estimates will be billed a minimum of ½ hour of labor. In addition you will be billed for return freight. Horizon accepts money orders and cashier's checks, as well as Visa, MasterCard, American Express, and Discover cards. By submitting any item to Horizon for service, you are agreeing to Horizon's Terms and Conditions found on our website http://www.horizonhobby.com/content/_service-center_render-service-center.

ATTENTION: Horizon service is limited to Product compliant in the country of use and ownership. If received, a non-compliant Product will not be serviced. Further, the sender will be responsible for arranging return shipment of the un-serviced Product, through a carrier of the sender's choice and at the sender's expense. Horizon will hold non-compliant Product for a period of 60 days from notification, after which it will be discarded.

Warranty and Service Contact Information

Country of Purchase	Horizon Hobby	Contact Information	Address
United States of America	Horizon Service Center (Repairs and Repair Requests)	servicecenter.horizonhobby.com/RequestForm/	4105 Fieldstone Rd Champaign, Illinois, 61822 USA
	Horizon Product Support (Product Technical Assistance)	productsupport@horizonhobby.com. 877-504-0233	
	Sales	websales@horizonhobby.com 800-338-4639	
EU	Horizon Technischer Service	service@horizonhobby.eu	Hanskampring 9 D 22885 Barsbüttel, Germany
	Sales: Horizon Hobby GmbH	+49 (0) 4121 2655 100	

IC Information

IC: 6157A-EFLA6420BL

Under Industry Canada regulations, this radio transmitter may only operate using an antenna of a type and maximum (or lesser) gain approved for the transmitter by Industry Canada. To reduce potential radio interference to other users, the antenna type and its gain should be so chosen that the equivalent isotropically radiated power (e.i.r.p.) is not more than that necessary for successful communication.

This device complies with Industry Canada licence-exempt RSS standard(s). Operation is subject to the following two conditions: (1) this device may not cause interference, and (2) this device must accept any interference, including interference that may cause undesired operation of the device.”

FCC Information

FCC ID: BRWEFLA6420BL

This equipment has been tested and found to comply with the limits for Part 15 of the FCC rules. These limits are designed to provide reasonable protection against harmful interference in a residential installation. This equipment generates uses and can radiate radio frequency energy and, if not installed and used in accordance with the instructions, may cause harmful interference to radio communications.

However, there is no guarantee that interference will not occur in a particular installation. If this equipment does cause harmful interference to radio or television reception, which can be determined by turning the equipment off and on, the user is encouraged to try to correct the interference by one or more of the following measures:

- Reorient or relocate the receiving antenna.
- Increase the separation between the equipment and receiver.
- Connect the equipment to an outlet on a circuit different from that to which the receiver is connected.

This device complies with part 15 of the FCC rules. Operation is subject to the following two conditions: (1) This device may not cause harmful interference, and (2) this device must accept any interference received, including interference that may cause undesired operation.

Compliance Information for the European Union



EU Compliance Statement: Horizon Hobby, LLC hereby declares that this product is in compliance with the essential requirements and other relevant provisions of the RED Directive.

A copy of the EU Declaration of Conformity is available online at: <http://www.horizonhobby.com/content/support-render-compliance>.

Instructions for disposal of WEEE by users in the European Union



This product must not be disposed of with other waste. Instead, it is the user's responsibility to dispose of their waste equipment by handing it over to a designated collection point for the recycling of waste electrical and electronic equipment. The separate collection and recycling of your waste equipment at the time of disposal will help to conserve natural resources and ensure that it is recycled in a manner that protects human health and the environment. For more information about where you can drop off your waste equipment for recycling, please contact your local city office, your household waste disposal service or where you purchased the product.



Replacement Parts – Ersatzteile – – Pièces de rechange – Recapiti per i ricambi –

Part # • Nummer Numéro • Codice	Description	Beschreibung	Description	Descrizione
EFLU3950	UMX TIMBER BNF BASIC	UMX TIMBER BNF BASIC	UMX TIMBER BNF BASIC	UMX TIMBER BNF BASIC
EFLU3951	FUSE W/ PUSHRODS:	FUSE W/PUSHRODS:	FUSE W/PUSHRODS:	FUSE W/PUSHRODS:
EFLU3952	WING W/ HARDWARE	WING W/HARDWARE	WING W/HARDWARE	WING W/HARDWARE
EFLU3953	TAIL SET WITH HORNS	TAIL SET WITH HORNS	TAIL SET WITH HORNS	TAIL SET WITH HORNS
EFLU3954	LANDING GEAR SET	LANDING GEAR SET	LANDING GEAR SET	LANDING GEAR SET
EFLU3955	BATTERY HATCH	BATTERY HATCH	BATTERY HATCH	BATTERY HATCH
EFLU3956	LED SET	LED SET	LED SET	LED SET
EFLU3957	DECAL SET	DECAL SET	DECAL SET	DECAL SET
EFLU3958	SPINNER	SPINNER	SPINNER	SPINNER
EFLU3960	LEADING EDGE SLATS	LEADING EDGE SLATS	LEADING EDGE SLATS	LEADING EDGE SLATS
EFLU3961	PUSHRODS SET	PUSHRODS SET	PUSHRODS SET	PUSHRODS SET
EFLUM180BLB	BL180 Brushless Outrunner 3,000Kv	BL180 Brushless Outrunner 3,000Kv	BL180 Brushless Outrunner 3,000Kv	BL180 Brushless Out- runner 3,000Kv
SPMSA2030LO	2.3g linear long throw offset servo	2.3g linear long throw offset servo	2.3g linear long throw offset servo	2.3g linear long throw offset servo

– Optional Parts and Accessories –
– Optionale Bauteile und Zubehörteile –
– Pièces optionnelles et accessoires –
– Parti opzionali e accessori –

Part # • Nummer Numéro • Codice	Description	Beschreibung	Description	Descrizione
PKZ1039	Hook and Loop Set (5): Ultra Micros	Klettband (5): Ultra Micros	Bande auto-agrippante (5)	Set fascette fissaggio (5): Ultra Micros
SPMA3060	USB-Interface: UM AS3X Programmer	UM AS3X Programmiergerät	Interface USB pour module AS6410NBL	
EFLUC1007	Celectra 2S 7.4V DC Li-Po Charger	Celectra 2S 7.4V DC Li-Po Ladegerät	Chargeur Celectra Li-Po 2S 7,4V	Celectra 2S 7.4V DC Li-Po Caricabatterie
EFLC1105A	1S-2S AC/DC Li-Po Balancing Charger	E-flite Ultra Micro-4, 4x9W, AC/DC Akkuladegerät, EU	Chargeur/équilibreur Li-Po 1 ou 2S AC/DC	1S-2S AC/DC Li-Po Caricatore con bilanciamento
EFLUC1008	DC Power Cord for EFLUC1007	Anschlußstecker mit Krokodilklemmen für EFLUC1007	Câble d'alimentation pour EFLUC1007	Cavo alimentazione per EFLUC1007
EFLB2002S30	200mAh 2s 7.4V DC Li-Po, 26AWG	200mAh 2S 7.4V 30C Li-Po Akku	Batterie Li-Po 2S 7,4V 200mA 30C, 26AWG	200mAh 2S 7.4V 30C Li-Po, 26AWG
EFLB2802S30	280mAh 2s 7.4V DC Li-Po, 26AWG	280mAh 2S 7.4V 30C Li-Po Akku	Batterie Li-Po 2S 7,4V 280mA 30C, 26AWG	280mAh 2S 7.4V 30C Li-Po, 26AWG
EFLA700UM	Charger Plug Adapter: EFL	Ladekabel Adapter EFL	Adaptateur pour prise chargeur - EFL	Adattatore connettore caricabatterie: EFL
EFLA7001UM	Charger Plug Adapter: Thunder Power	Ladekabel Adapter Thunder Power	Adaptateur pour prise chargeur - Thunder Power	Adattatore connettore caricabatterie: Thunder Power
EFLC4000/UK/AU/EU	AC to 12V DC, 1.5 Amp Power Supply (Based upon your sales Region)	Netzteil 12V 1,5 A (Basierend nach Vertriebsregion)	Alimentation CA vers 12V CC, 1,5 A (En fonction de votre région)	Alimentatore CA - 12V CC da 1,5 A (in base al Paese di vendita)
EFLA111	Li-Po Cell Voltage Checker	E-flite Li-Po Cell Volt Checker	Contrôleur de tension des éléments Li-Po	Strumento per misura tensione celle LiPo
	DXe DSMX 6-Channel Transmitter	DXe DSMX 6-Kanal Sender	Emetteur DXe DSMX 6 voies	DXe DSMX Trasmettitore 6 canali
	DX6e DSMX 6-Channel Transmitter	DX6e DSMX 6-Kanal Sender	Emetteur DX6e DSMX 6 voies	DX6e DSMX Trasmettitore 6 canali
	DX6 Gen 2 DSMX 6-Channel Transmitter	DX6 Gen 2 DSMX 6-Kanal Sender	Emetteur DX6 Gen 2 DSMX 6 voies	DX6 Gen 2 DSMX Trasmettitore 6 canali
	DX7 Gen 2 DSMX 7-Channel Transmitter	Spektrum DX7 Gen 2 7 Kanal Sender	Emetteur DX7 Gen 2 DSMX 7 voies	DX7 Gen 2 DSMX Trasmettitore 7 canali
	DX8 Gen 2 DSMX 7-Channel Transmitter	Spektrum DX7 Gen 2 8 Kanal Sender	Emetteur DX8 Gen 2 DSMX 8 voies	DX8 Gen 2 DSMX Trasmettitore 8 canali
	DX9 DSMX 9-Channel Transmitter	Spektrum DX9 9 Kanal Sender	Emetteur DX9 DSMX 9 voies	DX9 DSMX Trasmettitore 9 canali
	DX18/18QQ DSMX Transmitter	Spektrum DX18/18QQ nur Sender	Emetteur DX18/18QQ DSMX	DX18/18QQ DSMX Solo trasmettitore
	DX20 DSMX Transmitter	Spektrum DX20 nur Sender	Emetteur DX20 DSMX	DX20DSMX Solo trasmettitore



UMX™ Timber™

© 2017 Horizon Hobby, LLC.

E-flite, Timber, AS3X, UMX, DSM, DSM2, DSMX, ModelMatch, Bind-N-Fly, BNF, Celectra and the Horizon Hobby logo are trademarks or registered trademarks of Horizon Hobby, LLC.

The Spektrum trademark is used with permission of Bachmann Industries, Inc.

Futaba is a registered trademark of Futaba Denshi Kogyo Kabushiki Kaisha Corporation of Japan.

All other trademarks, service marks and logos are property of their respective owners.

US 7,898,130. US D578,146. PRC ZL 200720069025. PRC ZL 2007001249. US 8,672,726.

Other patents pending.

www.e-fliterc.com