

# INSTRUCTION MANUAL

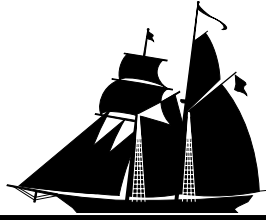

**MODEL SHIPWAYS**  
• QUALITY KITS SINCE 1946 •

# *Modeling The US Brig Syren 1803*



**Kit No. MS2260**  
Scale: 3/16" = 1 ft.  
Overall Length: 33"  
Height: 27"

Instructions and model prototype  
prepared by **Chuck Passaro**

MADE IN THE USA WITH PRIDE BY  
**MODEL SHIPWAYS**  
A DIVISION OF MODEL EXPO

[WWW.MODELEXPO-ONLINE.COM](http://WWW.MODELEXPO-ONLINE.COM)

© COPYRIGHT MODEL EXPO 2009



# Introduction

**The US brig Syren** USS Syren, a 240-ton brig, was built by Nathaniel Hutton at Philadelphia in 1803. On September 27th, she set sail for Gibraltar under the command of Lt. Charles Stewart.

Syren cruised the Mediterranean during the spring and summer of 1804 and participated in the attacks on Tripoli. She remained there for almost a year after the peace treaty with Tripoli was signed on June 10, 1805. Departing Gibraltar on May 28 of 1806, she reached the Washington Navy Yard in early August, where she was laid up until her reactivation in 1807.

During her service in the War of 1812, she was captured by the 74-gun HMS Medway after an 11-hour chase.

---

## Bibliography of sources

**A Model of an English Brig of War - Notes and Photographs by Erik A. R. Ronnberg, Jr.**  
Nautical Research Journal Vol.35 No.4 December 1990

**A Naval Architectural Study of the U.S. Brig Argus - W.M.P. Dunne** Nautical Research Journal Vol.34 No.3 September 1989

**The Search For Speed Under Sail - Howard Chapelle**  
**Naval Documents Related to Quasi War Between the United States and France**

**Naval Documents Related to the United States Wars with the Barbary Powers**

**Shipbuilders Repository (London 1789)**

**The Masting and Rigging of English Ships of War - James Lees**

**The History of the American Sailing Navy - Howard Chapelle**

**Sailing Warships of the US Navy - Donald Canney**

**The Construction and Fitting of the English Man of War - Peter Goodwin**

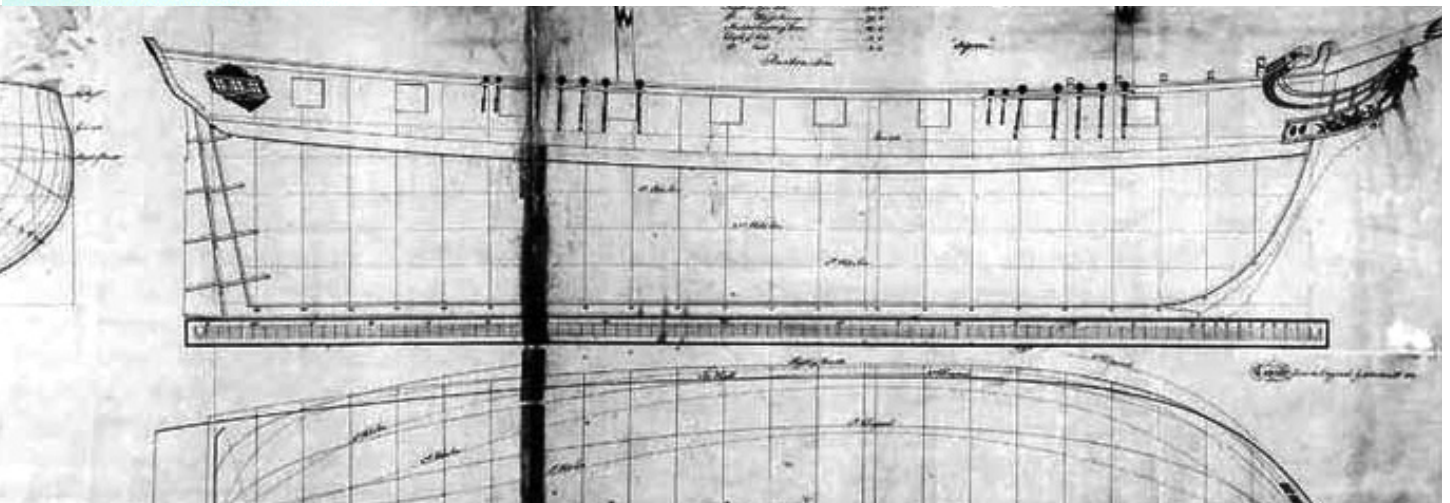
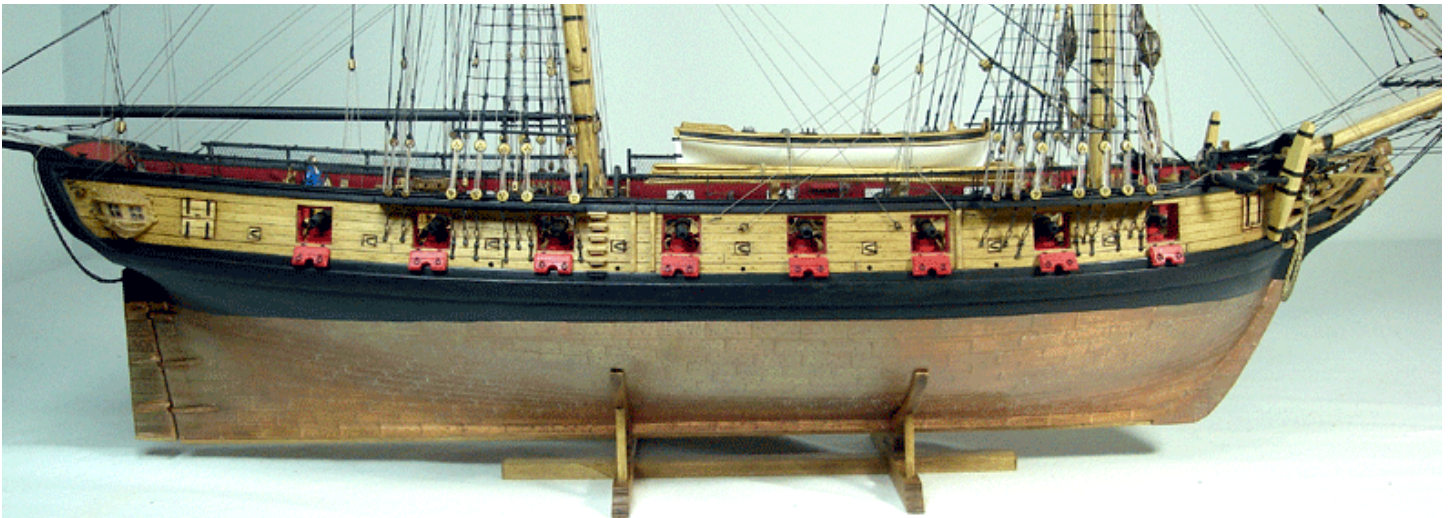

*A copy of the original draft for the Brig Syren designed by Benjamin Hutton. Built by Nathaniel Hutton of Philadelphia.*



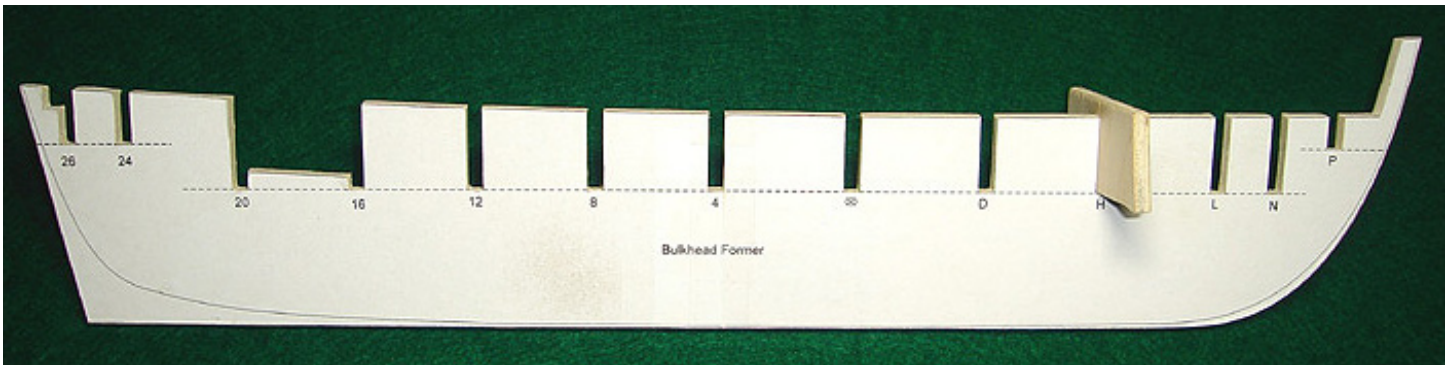

The bulkhead former has been removed and the slots tested for a proper fit. Paper templates were used while building the prototype but all of the reference lines shown in the photo have been laser-etched onto each part for you.

## CHAPTER ONE - The Bulkhead Former, Rabbet, Keel and Stem Knee

Remove the bulkhead former which has been laser cut for you. Remove one of the bulkheads as well or test the slot width by using a scrap piece of wood the same thickness. Slide it into each slot to see if they fit well. They should fit snug into them. If they are too tight you may have to sand them so you will have a better fit. The bulkheads should not fit loosely into the slots either. If this should happen you can shim the slots for a tighter fit.

You will notice that the bulkhead former has been scribed by the laser cutter to create some reference lines. The reference line that runs along the bottom of the bulkhead former is the bearding line. You will use this reference to cut the rabbet. Some other reference lines appear on the starboard side of the bulkhead former only. These scribed lines appear directly under the bulkhead slots and will help you position each bulkhead properly.

The photos presented through out this instruction booklet show the prototype model being built. Paper templates were used on the bulkhead former and other materials and you will see them quite frequently. These templates were used to locate the reference lines during the prototypes design and construction. Upon its completion, these reference lines were scribed into each piece with the laser in order to make it easier for you to assemble. Now it is time to form the rabbet along the outside edge of the bulkhead former. See the illustration below. Creating the rabbet will make planking much easier. Most kits available commercially make no mention of the rabbet or why it should be created. As you plank the outside of the hull, the planking strips are inserted into the rabbet. This

creates a neat, clean edge where the planking meets the keel, stem and sternpost. The planks are also held in place better as you bend them around the sharp curve at the bow.

To create the rabbet, a 3/32" x 1/16" basswood strip is glued to the bottom edge of the BF. An additional piece is also glued along the stern. The strip is not as wide as the BF so after it is glued into position there will be a gap on either side of it. Be sure to center the strip as it is being glued. Pre-form the basswood strip first by soaking it in water for ten minutes. Then clamp it around the BF with a small clamp and a rubber band. Once it is dry, the strip will hold its shape well and this will make it much easier to glue into position. If you don't pre-form the strip, it would be difficult to get it centered properly while trying to forcefully bend it onto the BF. See the photo provided which shows the strip being shaped after it was clamped around the bulkhead former (next page).

After you glue the strip into position let the glue dry overnight. The following day you can start shaping the rabbet. There needs to be a smooth taper from the bearding line into the rabbet. This is very important because without such a smooth transition, your hull can not be planked properly. You will end up having to do a lot more sanding; and after all of it, the hull will probably not have the correct shape anyway. Score the bulkhead former with a sharp #11 blade along the bearding line. Don't make the cut too deep. Only apply enough pressure to score the wood in order to create a slight cut mark. The cut will act as a stop and prevent you from over shooting the bearding line as

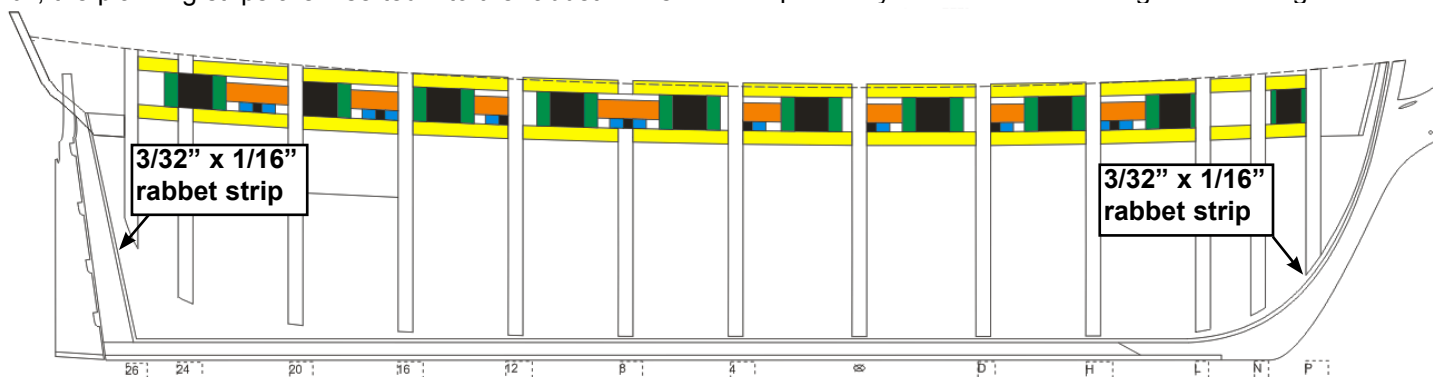



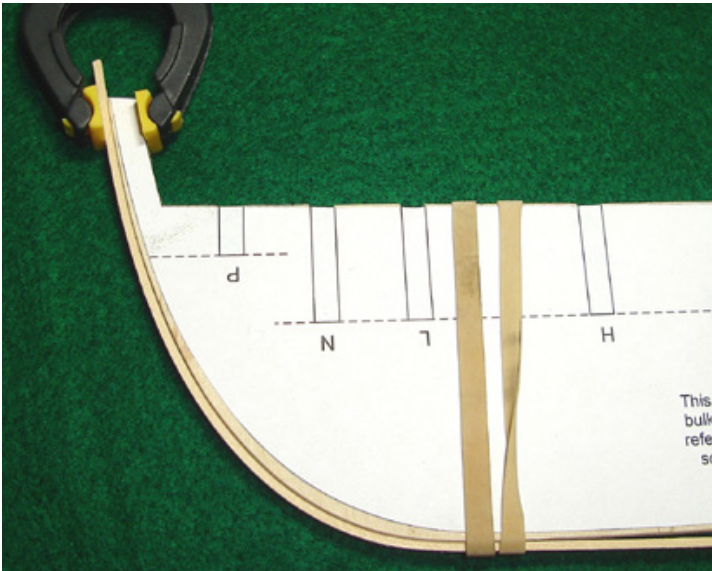

Pre-forming the rabbet strip before gluing it to the bulkhead former.

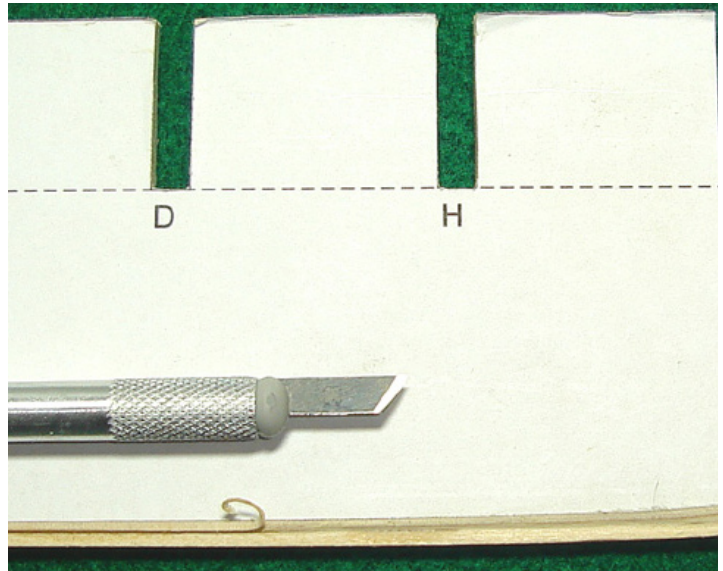

Carving the taper towards the rabbet from the bearding line with a sharp blade in my hobby knife.

you carve. Use a sharp blade (like the one shown) to carve the taper from the bearding line to the edge of the rabbet strip. It really isn't that difficult but may make a big mess. Sand it smooth afterwards.

The port side of the bulkhead former has not been laser etched with reference lines. The laser cutter can only mark one side of the wood sheet. But the laser was periodically allowed to perforate through to the other side. You can see the holes and all you need to do is trace them to establish the bearding line on the other side. Once you do this, simply carve the rabbet as you did on the first side of the bulkhead former.

Once the bulkhead former is prepared you can remove the stem knee using a sharp blade.

The stem knee also tapers to a slimmer thickness. See the illustration on page 5. The taper can be sanded into both sides of the stem knee with a sanding block. Be careful not to sand the inside edge of the stem knee. That should remain at 3/16" thick. If you do happen to sand it down accidentally, the rabbet will not be deep enough once the you glue it onto the bulkhead former. The stem knee should only be tapered where the figurehead will be positioned. Then it gradually increases in thickness back to 3/16". Double check the thickness along the rabbet before you glue it on. If you need to carve the rabbet deeper afterwards, it would be an acceptable remedy as well. When you glue the stem knee to the bulkhead for

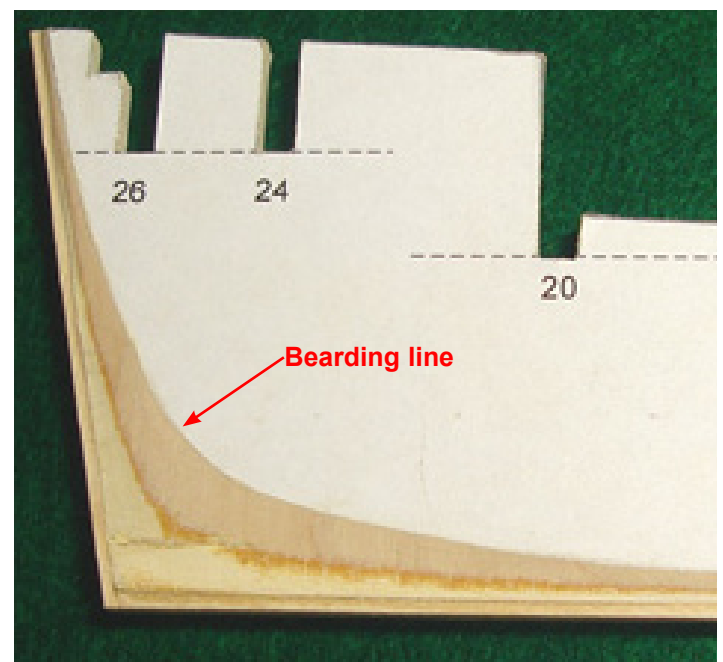
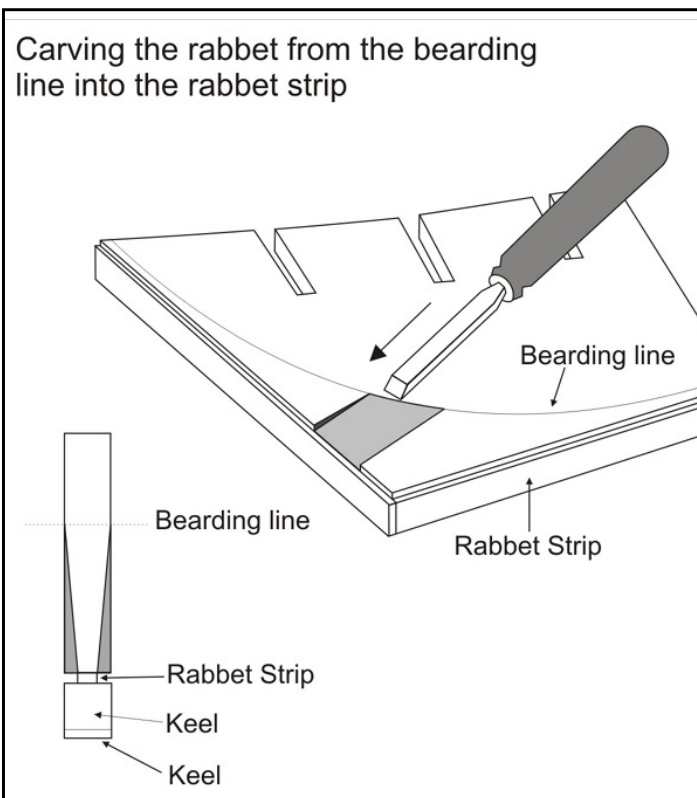

The taper towards the rabbet is completed at the stern.



mer make sure there is equal space on either side of the rabbet. Since the stem is wider than the rabbet strip, this is what will ultimately create your rabbet. See the photo above which shows the stem knee glued into position.

You will be using a 3/16" x 3/16" basswood strip for the keel. Glue it into position and let it hang off the end of the bulkhead former at the stern. Center it on the rabbet strip like you did with the stem knee. The rabbet formed by the keel should be the same depth on both sides of the bulkhead former. Notice in the photo above that the stem is notched out to accept the false keel. There should be 1/16" space left on the bottom of the keel where we will eventually glue the false keel into position. The false keel was placed on ships during this period so it would take the brunt of any damage if the ship were to hit bottom. In fact it was only held onto the keel with nails and was designed to even fall off if the damage was severe. This thin strip was easier to replace than an entire keel. The Syren will have a copper-plated hull. The keel included. The false keel however, was not copper plated. Therefore we will not permanently glue it into position at this time. Tape the 1/16" x 3/16" Basswood strip into position temporarily. This will keep the hull flat on your work table. It will also prevent the bottom corner of the stem knee from getting damaged as you work. After the hull and keel is coppered we will glue the false keel into place permanently.

You will also notice in the last photo (next page) that the keel and *temporary* false keel were left extra long. They extend about 3/4" off the end of the bulkhead former at the stern. The stern post won't be added until after the hull has been completely planked. It will be easier to run the planks right off the end of the bulkhead former at the stern. This way you won't have to try and cut each plank to fit in the rabbet as you proceed. All of the planking can be trimmed perfectly to the edge of the rabbet before you add the stern post later. It makes for a much neater job. This technique also seems to save a lot of time. So rather than guess how long the keel should be now, leave it extra long until after the stern post has been glued into position. Then you will be able to neatly trim the keel and *temporary* false keel with more accuracy.

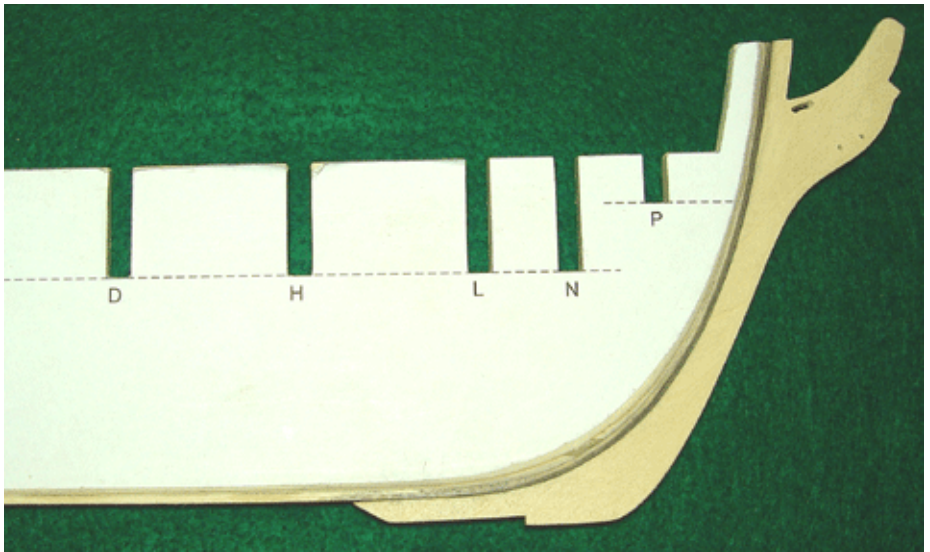

*Stem knee has been glued onto the bulkhead former. The holes for the gammoning slot and bobstays were drilled first.*

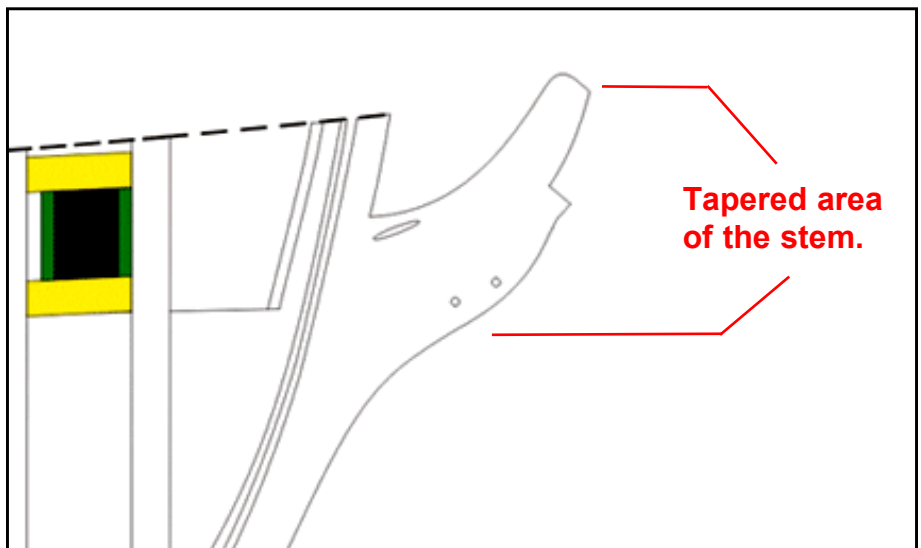
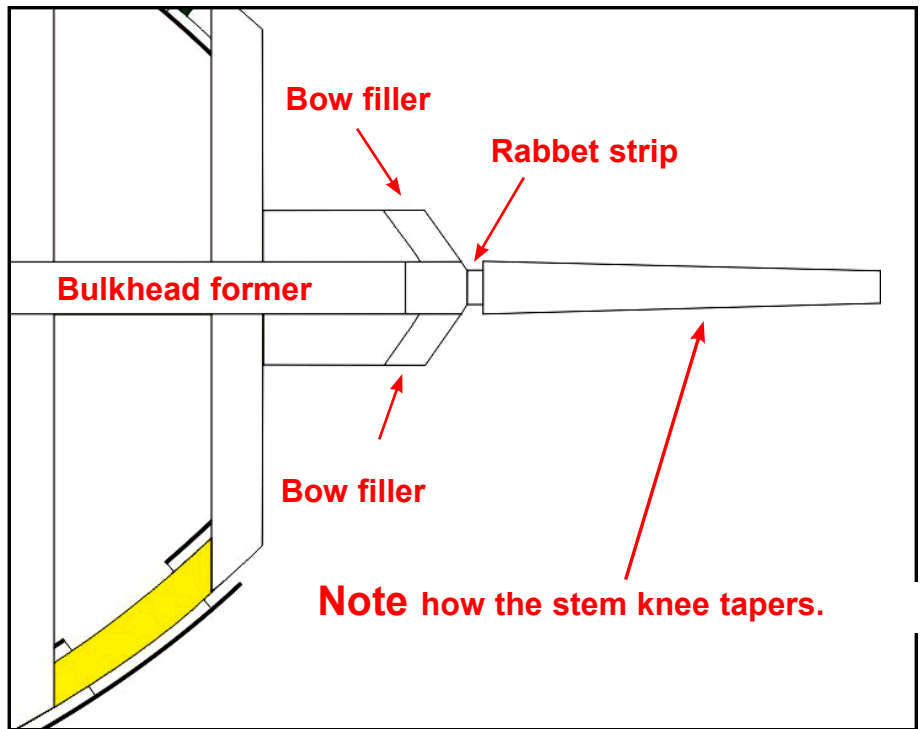



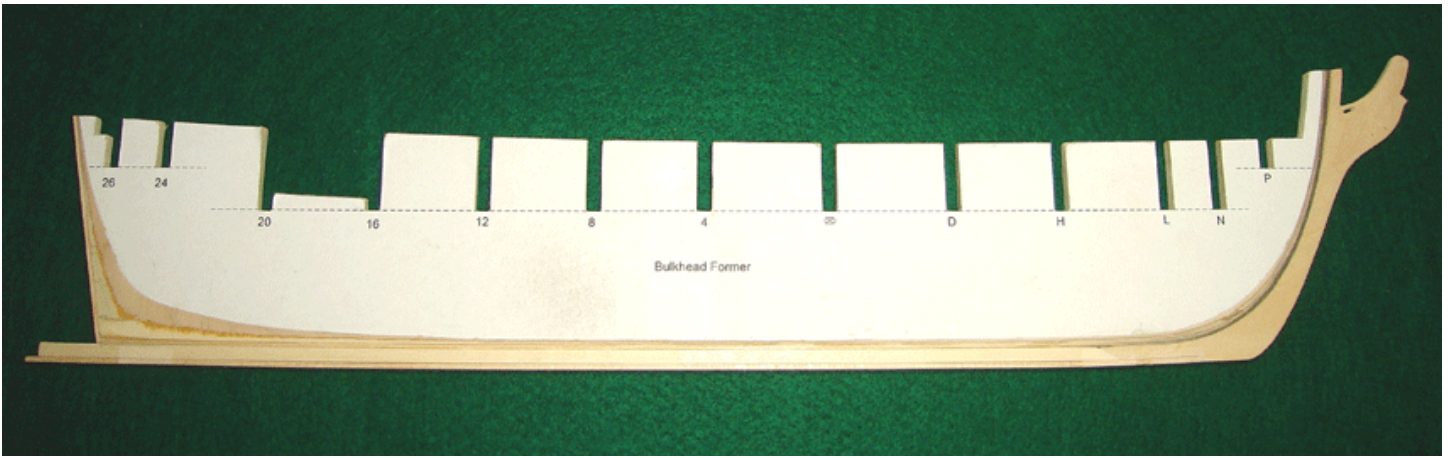

Keel (3/16" x 3/16") was glued to the bottom of the bulkhead former. Note how it was left longer and runs off the end of the bulkhead former at the stern. The false keel was temporarily taped in position until after the hull has been planked and copper plated.

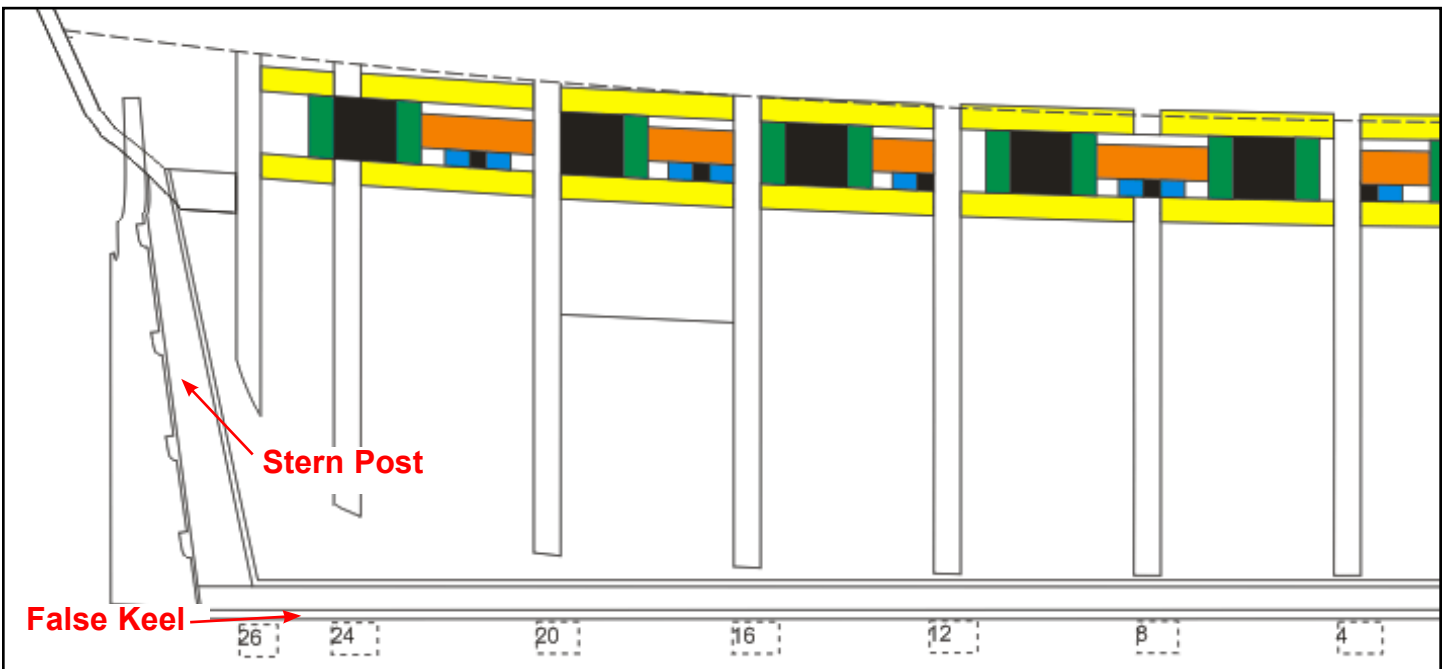
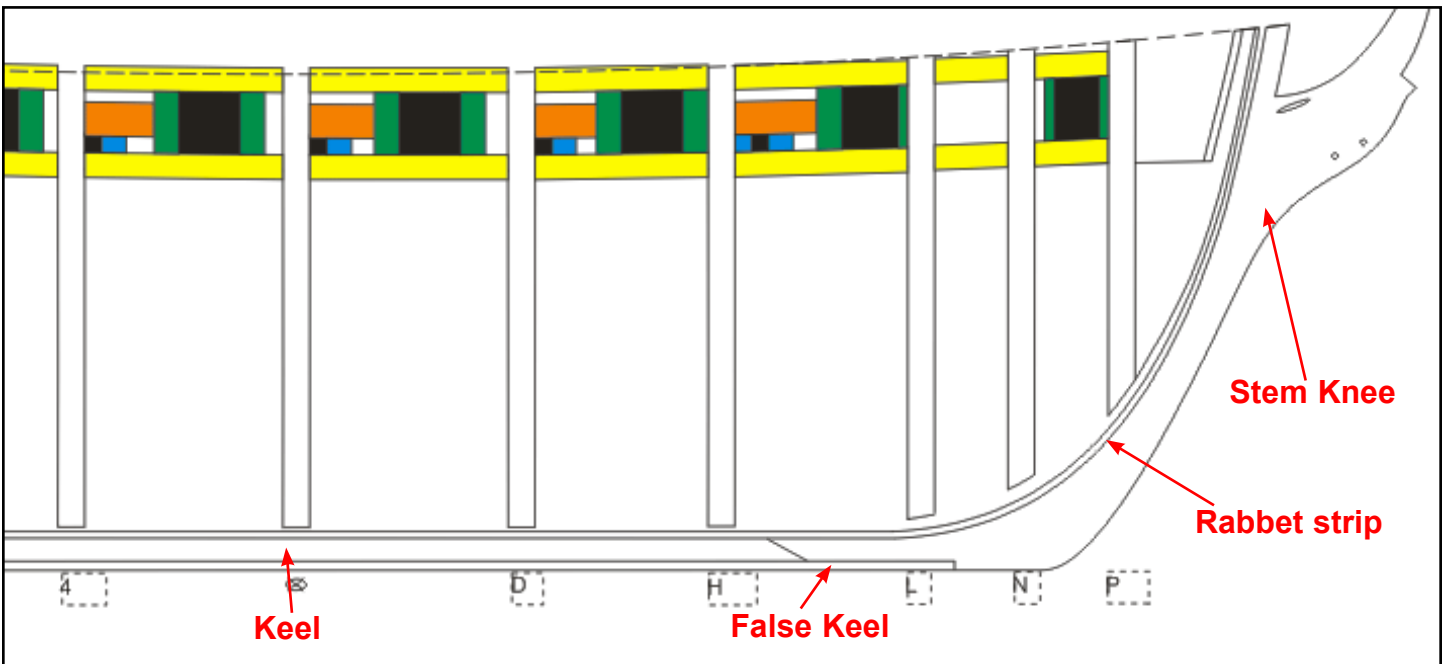

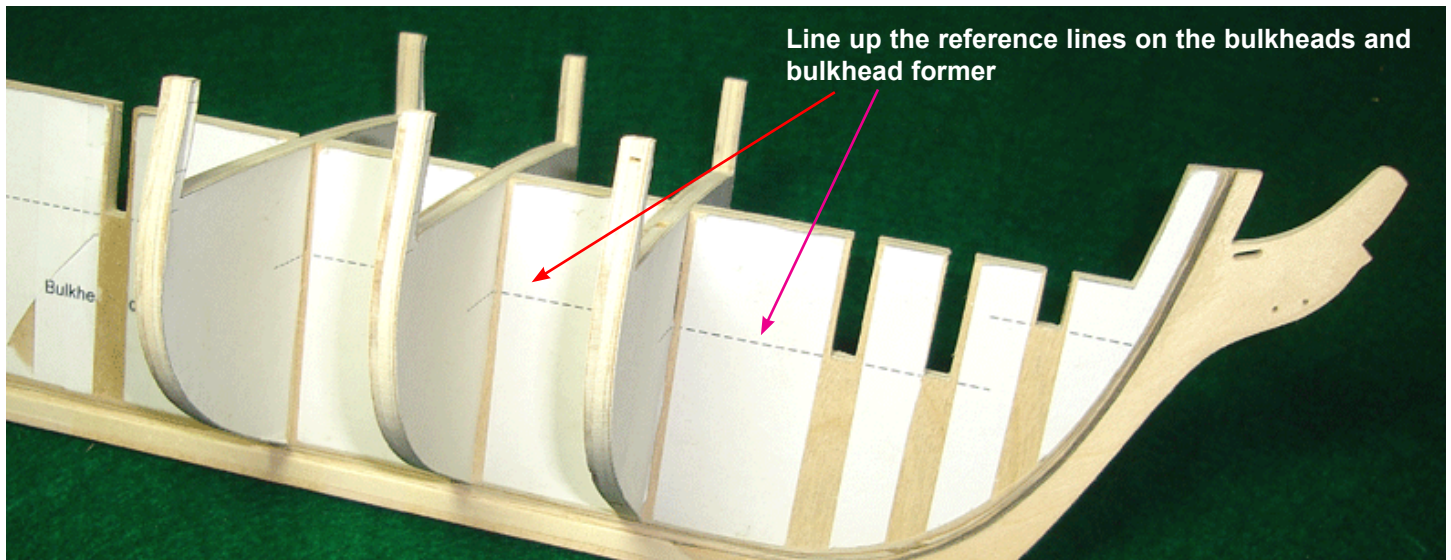

## CHAPTER TWO - The Bulkheads and Bulkhead Fillers

Remove the thirteen bulkheads and sand their edges to smooth out any rough spots and burn marks from the laser. You will notice that some of the bulkheads have a dashed line scribed onto them. They represent the bevel that should be created on the outside edge of each of them. Only those bulkheads that will have the most severe bevels have dashed lines on them for reference. This doesn't mean that the others won't be beveled. All of the bulkheads will have some degree of beveling. It will however be only slight and easier to achieve after all of the bulkheads are *temporarily* in position.

Slide each bulkhead into their corresponding slots and make sure they are squared to the bulkhead former. Line up the dashed line on the bulkhead former with the dashed line scribed on each bulkhead. This line is used to make sure the bulkheads are leveled properly in their respective slots.

The bulwark frames are somewhat thin. This is the area that will create the sides of the hull above the deck level. They are actually a little thicker than they will ultimately end up being. After you establish the bevels (as indicated by the dashed lines) the bulwarks should end up being 1/8" thick at the cap rail level. They can be 5/32" thick at deck level (it gradually gets wider as you approach the deck level). The inside of the hull along the bulwarks will eventually be thinned down even further. This won't be done until after the hull is completely framed and planked. The top of the bulwarks will eventually be thinned down to 3/32" thick. At the deck level each bulwark frame will be 1/8" thick. They are quite delicate so be careful not to break them.

**NOTE: The scribed sides of each bulkhead should face towards the bow for all lettered bulkheads. They should face towards the stern for all of the numbered bulkheads.**

Bevel all of your bulkheads before you place them into their slots of the bulkhead former. The drawing below

shows you how to bevel the outboard edge first. The dashed line is there only as a guide. **DO NOT** initially bevel your bulkhead edge to these reference lines. Shape the edge just short of each bevel line (leave about 1/64"). Once all of the bulkheads are temporarily in position you will *fair* the hull. This term refers to the process of preparing the outside shape of the hull so the hull planking will lay flat along the edges of each bulkhead. Use a folded sheet of sandpaper that is long enough to span across three bulkhead edges. Sand the outside edges of the bulkheads two or three at a time. This will finish the beveling process and fair the hull for planking. A good tip is to imagine the hull as a solid block of wood as you sand it into shape.

Use a planking strip (1/8" x 1/16") to check your work. As you lay it across the hull from bow to stern, the planking should lay flat against the edges of the bulkheads. Continue to make adjustments until you are satisfied. When the outside of hull is completed you should do the same for the inside. The inside edge of the bulwarks should be faired as well. Keep all of your bulkheads a

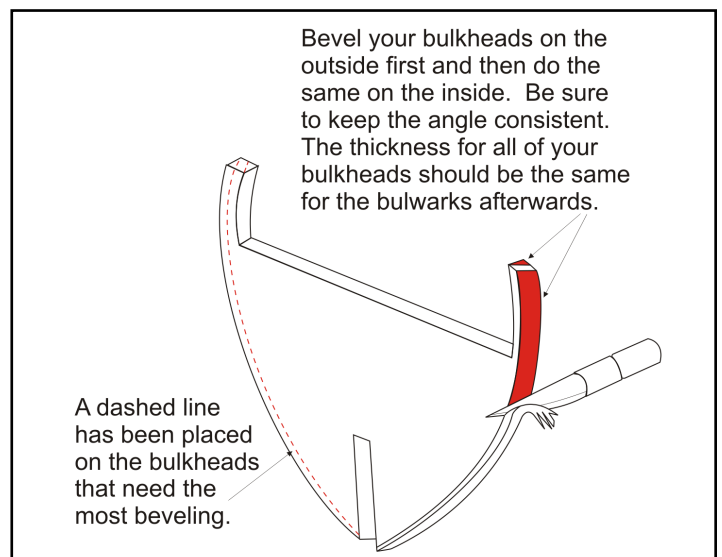



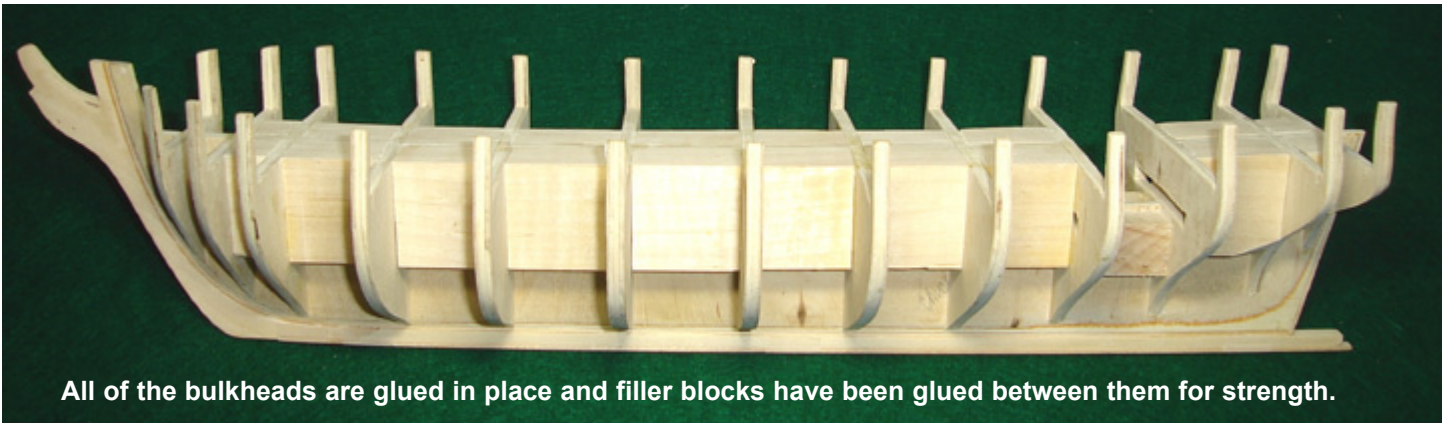

All of the bulkheads are glued in place and filler blocks have been glued between them for strength.

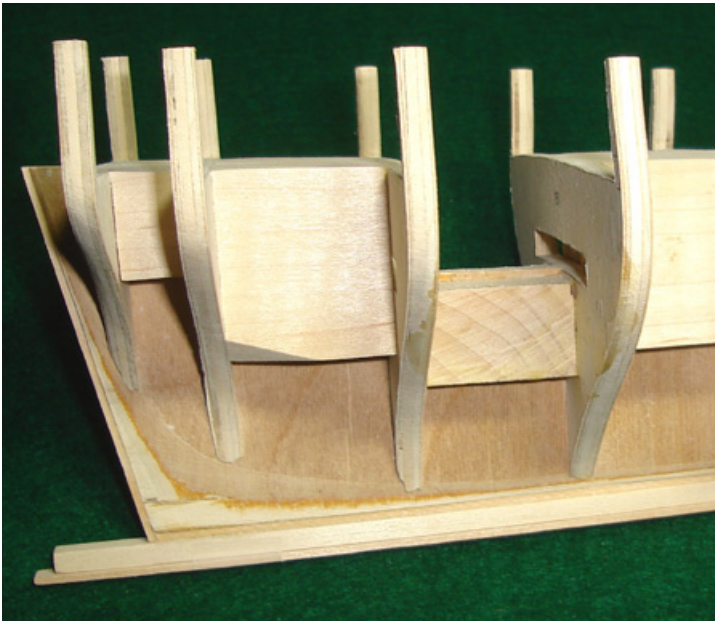

Close up of the filler blocks at the stern. Note how the filler block between bulkheads 16 and 20 is positioned. Place it below the slots of both bulkheads.



The planking between bulkheads 16 and 20 is completed. It creates a platform to simulate the lower deck which will be visible through the open companionway.

consistent thickness as you do so. Don't make them too thin yet. Remember... it is better to keep them a little thicker and stronger at this point. It would be best to do the final sanding after the outside of the hull is planked. Only remove what is necessary at this time to consistently shape the inside of the bulwarks. Once you are satisfied, the bulkheads can be permanently glued into the bulkhead former.

You will notice a slot cut into bulkheads 16 and 20. These slots will be used to plank a simulated lower deck platform. If you intend to have the companionway doors open this deck will be visible (barely). It will serve as a platform for the ladder to rest on. But before you create this platform a series of filler blocks should be placed between each bulkhead.

The filler blocks can be made from any scrap lumber you have. A good size to use would be a 1" x 2" strip. Cut each filler block so fits snug between each bulkhead. Don't make them so tight that it forces your bulkheads to spread apart. This is very important. The filler blocks will strengthen the entire skeleton and prevent it from twisting or warping. If your bulkhead former is slightly warped it can usually be straightened out by using filler blocks. Simply create a jig or clamp your bulkhead assembly so it is straight and not twisted. Then glue your filler blocks into position on both sides of the bulkhead former. When you release it, the warp or twist should be gone. The jig can be created with a 1" x 6" board. Two wood strips are glued down the center. The space between each wood strip should be 3/16". This is just enough space for the keel to fit down into it. See the photo on the next page. The keel should fit tightly into this slot.

With the filler blocks completed you can plank the platform between bulkheads 16 and 20. Use 1/16" x 1/8" basswood strips. Run a pencil across the edge of each plank to simulate the caulking that was normally placed between them. There are other methods for doing this but a pencil creates a more subtle appearance for the caulking. There really is no need to treenail this platform since it will barely be visible. You may opt to treenail the deck and hull, but on this platform all of your efforts would hardly be seen. Techniques for treenailing will be discussed later in the project. Treenails were wooden pegs that were forced

through holes drilled into the planking. They passed through the planking into the ship's frames and fastened them securely into place. Treenails can add a lot of detail and interest to a ship model but depending on your skill level you might decide to omit them.

The platform was stained with MinWax Golden Oak wood stain. It produces a warm golden tone when used on basswood. The deck would have been a grey color and lighter than the planking on the outside of the hull. You might decide however, to keep them consistent. The prototype model will be stained exclusively with the golden oak color and all of the unpainted portions of the model will have a consistent look through out.

To complete chapter two, remove the two laser cut bow fillers and glue them into position. One for the port side and the other for the starboard. You will notice a dashed reference line was added as a guide to show the bevels required. These filler pieces should be beveled inboard and outboard before you glue them onto the bulkhead former. Again, it is probably better to bevel them only part-way until after they are glued to the bulkhead former. Then you can sand them further as the hull shape dictates. These bow fillers will give you more surface area to glue the hull planking onto. See the illustration on page 5 which shows the bow fillers in position. Note the proper bevel angles inboard and outboard in relation to the BF.

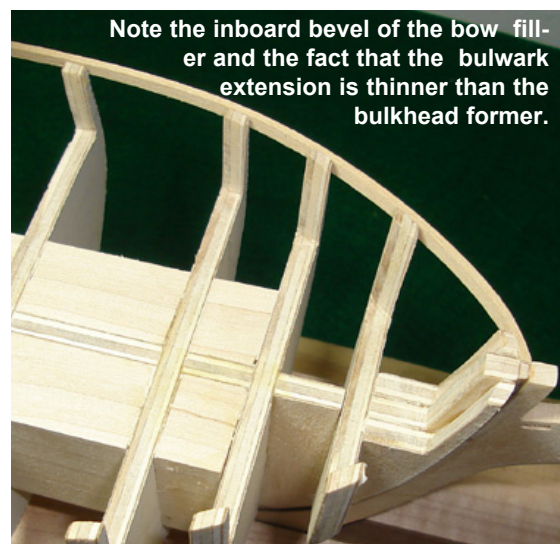
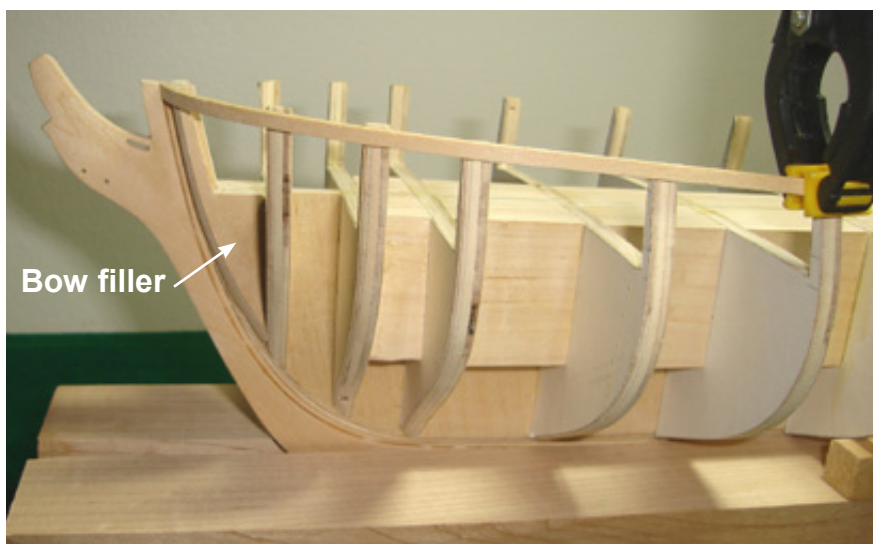
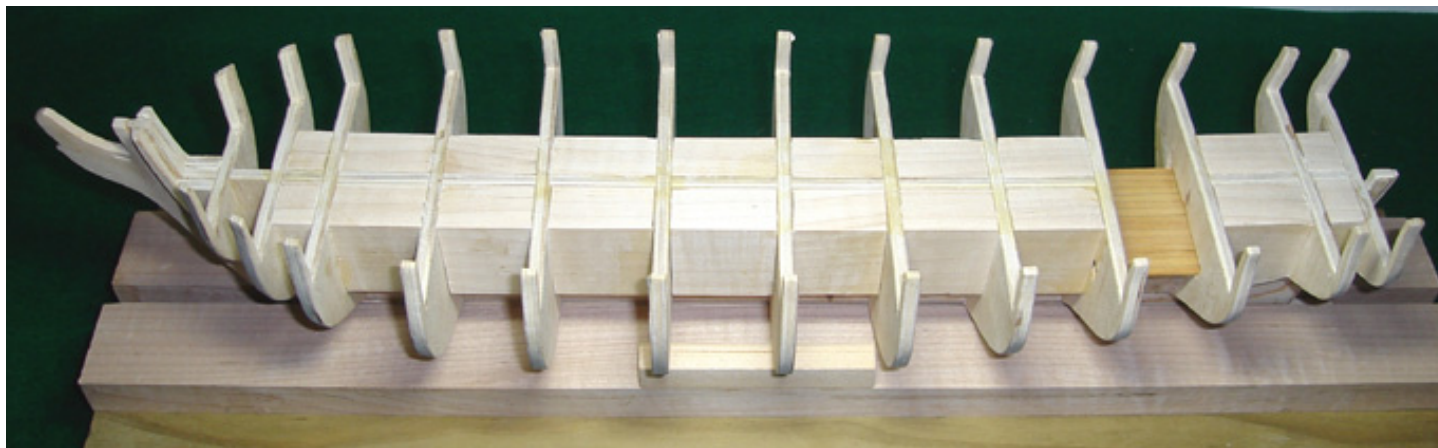

***It can not be emphasized enough how important it is to fair the hull properly. Check that a planking strip will lay flat across all bulkhead edges inboard and outboard. You can see in the photos above how a planking strip was inserted into the rabbet at the bow and left to bend naturally along the outside of the hull. That's when you are ready to move ahead to chapter three.***

**A Model Expo exclusive! Log on and join Chuck Passaro's Syren forum. Get help and building tips from fellow Syren builders and the designer himself!**

**For more information go to: [www.ModelExpo-online.com/Syren](http://www.ModelExpo-online.com/Syren)**



Framing plan being used to check the alignment of the bulkheads in the bulkhead former.

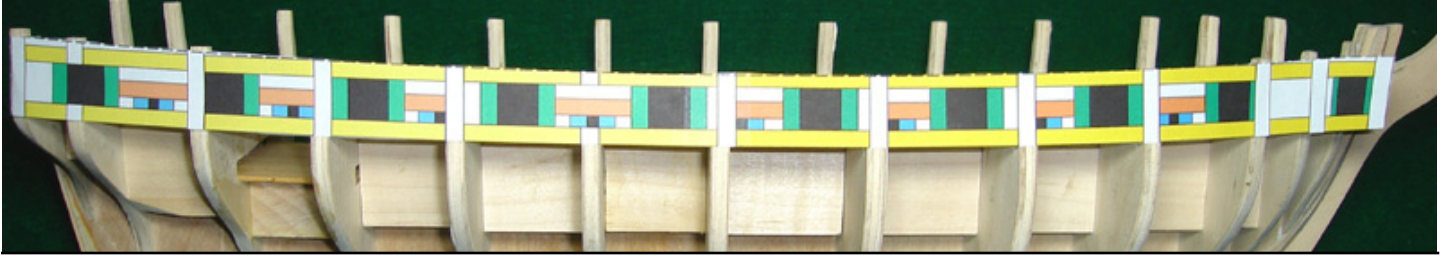

## Chapter Three - Framing the Gun Ports and Sweep Ports

Before you begin framing the gun ports examine the framing templates provided. Tape them together using the dashed lines for reference. You should have 3 templates when you are finished. One is an over head view of the framing plan which shows you the probable locations for the upright port frames and the approximate shape for your gun port sills and lintels. The other two templates will be taped to the hull as shown in the photo above. This is how you will mark the placement for your vertical frames later in the chapter.

You can trim these two templates (one for the port side and one for the starboard) so only the frames are showing. You won't need any of the other reference lines above and below the port sills and lintels. Again, take a look at the photo above. To start the framing process you can tape the framing template to your bulkheads in order to check their placement. As you can see in that photo, some of the bulkheads were not properly squared with the bulkhead former. This isn't such a big deal. The hull has been faired pretty well at this point. The only problem with having the bulkheads misaligned is that you might have to adjust where the vertical frames (green and blue) will be positioned later. There will always be some fluctuation in their position. It will not have any impact on maintaining the proper shape of the hull or placement of your gun ports. This you will soon see.

Even though the templates are provided in B&W, a framing plan is also provided (reduced in size) and color coded for you. The colors indicate the sequence you should follow while framing the ports. That order will be as follows. The yellow frames will be positioned first. They are for the gun port sills and lintels. Next the green frames will be added. They are the timbers that create the sides of each gun port. The red frames will be added next which define the top for each sweep port. Finally the blue timbers will be positioned which will complete the sweep port framing.

Remove the template from the hull and you will notice the three reference lines etched onto each bulkhead. The top two reference lines indicate the opening for the gun ports. The bottom line will be used to locate the top of the wales. The gun port sills will be framed first. Even though reference lines were added to each bulkhead for you, it will be best to use them only as a guide. Your bulkheads may not be sitting in their respective slots at precisely the same level. Use them as a guide to fasten a temporary batten across the hull. Fasten the batten to each bulkhead edge with a little brass nail. See the photo below. Once it is secured to the hull, look at it from various angles to see if it has a smooth run from bow to stern. Make any adjustments to it until you are satisfied there are no unsightly dips. After you have made the necessary adjustments, mark each bulkhead edge with a pencil along the top of the

Temporary batten fastened to the hull to establish the smooth run of the gun port sill.



**Gun port sill is completed on the starboard side and sanded inboard and out.**

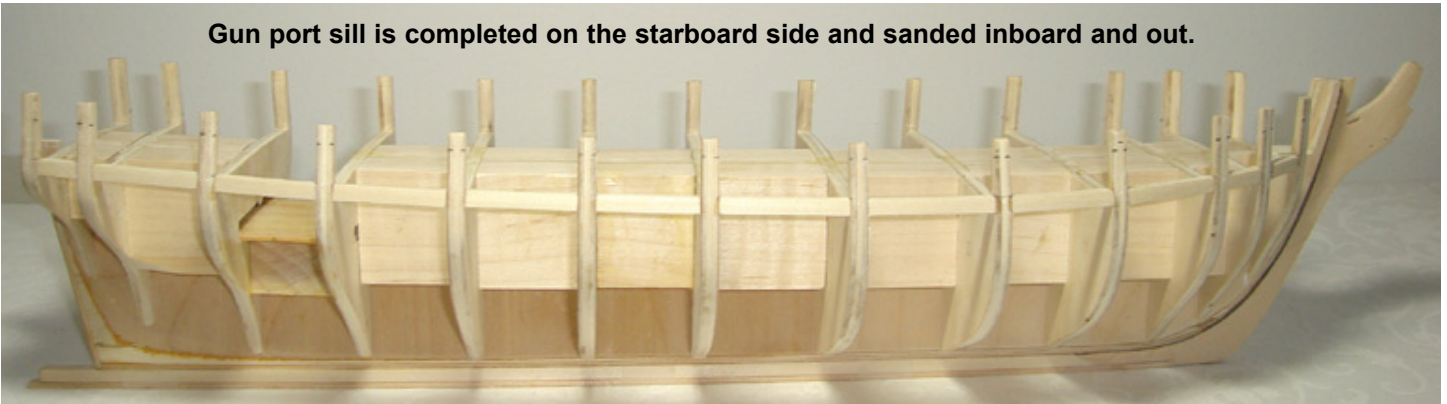

batten. This pencil line will reference the top of your gun port sill.

Most of the port framing will be done using Basswood strips that are  $\frac{1}{4}$ " x  $\frac{3}{16}$ " x 20". The side of the basswood strip that is  $\frac{1}{4}$ " will become the top of your gun port sills. You can use the overhead view of the framing plan to cut the approximate shape of each frame section. Make them a little longer than shown so you can sand them for a snug fit between each bulkhead. Don't make them too tight as this will force your bulkheads out of alignment. The wood strips are  $\frac{1}{4}$ " wide so they overlap the bulkhead edges inboard and outboard. The top of the gun port sills should be perfectly flat. Do not slope them inboard or outboard.

After all of the port sills are in position you can sand them inboard and outboard so they are faired with the rest of the hull. See the photo above which shows the gun port sills completed on the starboard side. Repeat this process on the other side of the hull. Once again you should imagine that you are shaping a solid hull while you sand the gun port framing. This is especially true at the bow where your frames should have a graceful curve when you are finished. See the photo below.

The process is the same for installing the gun port lintels. These will define the top of each port opening. Rather than run another batten across the hull it would probably be easier to just measure the gun port height from the top of the sill. The gun ports will be  $\frac{15}{32}$ " high. Simply measure this distance and mark the bulkhead edges for reference. It cannot be emphasized enough how important it is to make sure the batten you used to establish the run of your ports sills has a clean and smooth run from bow to stern. If the port sill is wavy and poorly situated then the lintels will follow suit. See the photo which shows the port sills and lintels in position. They have been sanded to a consistent thickness and match the profile of each bulwark stanchion. The lintels should be about  $\frac{1}{8}$ " thick at this point and the sills a little thicker at  $\frac{5}{32}$ ". You will eventually make the bulwarks even thinner. This won't be done until after the outside of the hull is planked. Another photo is provided above that shows both sides of the hull completed.

The GREEN frames which represent the sides of each gun port will be positioned next. Take your paper framing templates and remove the gun port sills and lintels (yellow frames). We will be using them to establish the positions

**Gun port sill and lintel faired at the bow. Notice the graceful curve established.**

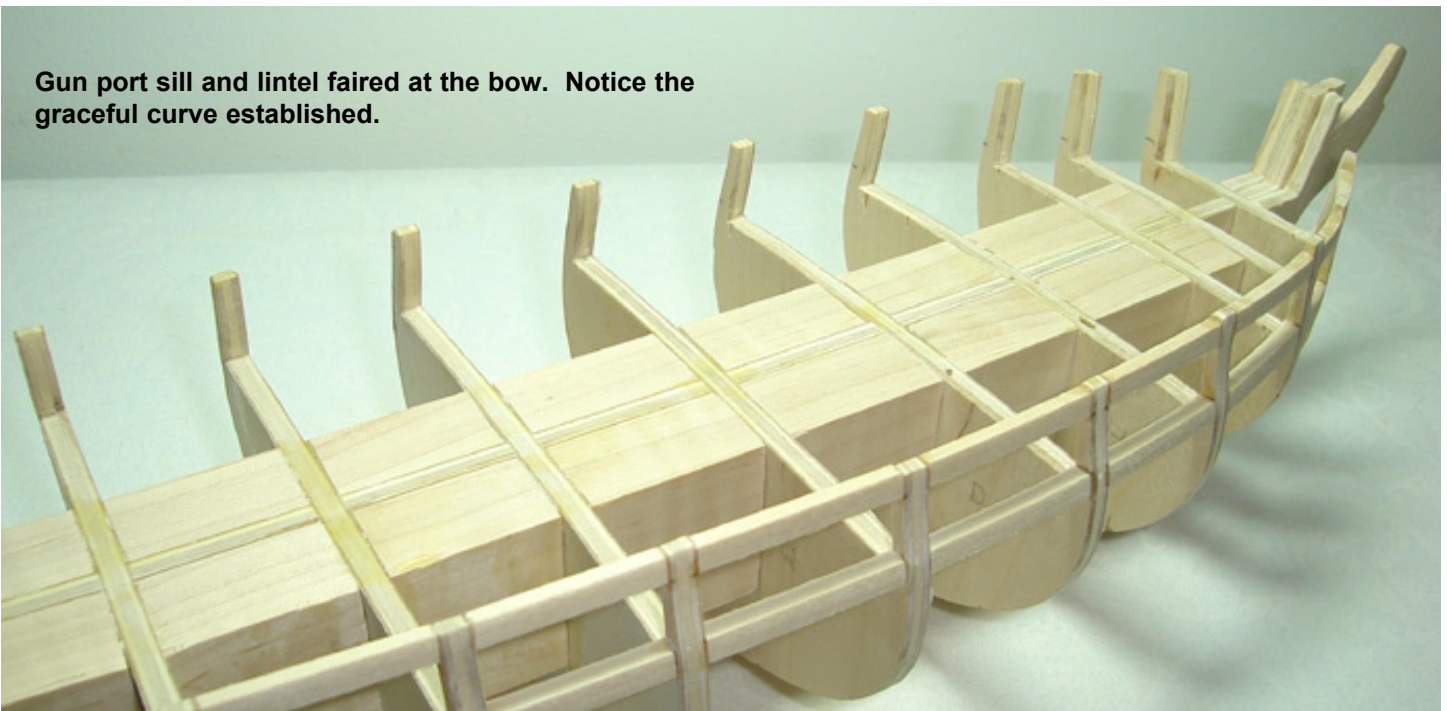



**Gun port sills and lintels are completed.**

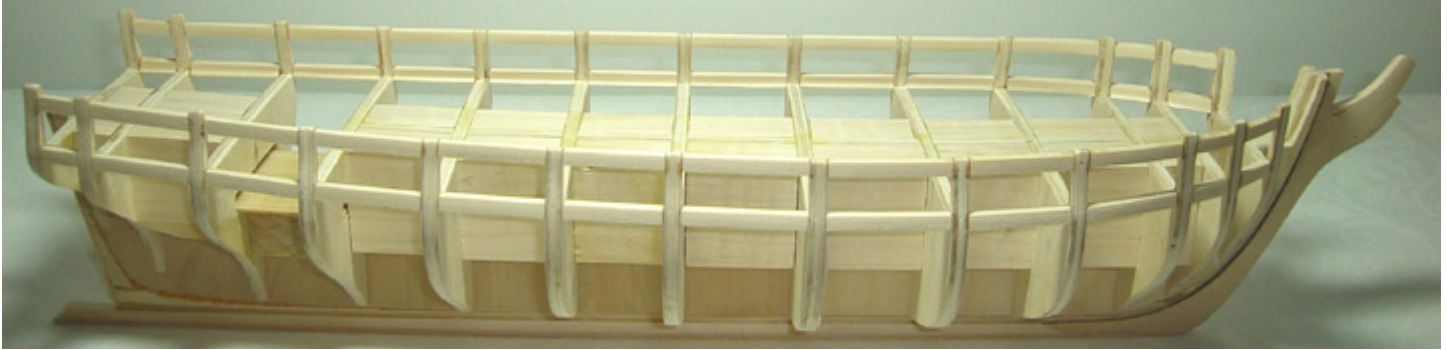

for the green framing. Tape the template to the hull as shown in the photo below. It is important to line the template up with bulkhead 26. Don't worry about where the other bulkheads fall. This was what I was referring to earlier when I mentioned it didn't matter if your bulkheads were slightly off. By lining the template up with bulkhead 26 your gun port spacing will be accurate across the hull. A mirrored version was provided for you so the same spacing can be established on both sides of the hull. This will keep the gun port spacing consistent on both sides. Mark the locations for each green frame on the gun port sills and lintels. Do this for every gun port except the bridle port. The bridle port is the forward-most port at the bow. You should not use the template as a guide to mark its location. This is ok since it will be centered directly between bulkheads N and P. Check the overhead version of the framing plan for details. There is no need to mark its location. If you examine the overhead framing plan you will also notice that not all of the green timbers are square to the bulkhead frames. The first two ports at the bow should have these timbers oriented as shown on the plan. There will also be instances where you may not be able to use a strip of wood that is 3/16" thick for some of the vertical frames. For example, 1/16" thick strips were used for the bridle gun ports. This might occur for other gun ports depending on whether you need to make adjustments after discovering your bulkheads were not aligned perfectly.

The aft-most green frame should be the last one you put into position. You will see on the framing plan that part of bulkhead 24 must be removed before you can glue that last green frame into place. Use a fine-toothed scroll saw blade to cut the bulkhead frame out between the gun port sill and lintel. Don't cut it out flush against the sill and lin-

tel. Leave a little room so you can sand it flush after it is removed. You will be surprised at just how strong your hull is at this stage. A jigsaw blade would do the trick as well. When you are sawing don't apply too much pressure and go slow. Glue the last stanchion into position afterwards and apply some Elmer's wood filler if you need to fill any cracks. Sand the inside edges of the gun port smooth with some very fine sandpaper to finish it off. See the photos provided.

With all of the green frames completed you can sand the hull inboard and outboard as you did before. Each frame should take on the shape of the hull guided by the profiles of your bulkheads. If you sand the hull after you finish each color frame it should be faired perfectly to accommodate the planking. But don't sand too much off the exterior of the hull. Once you sand the gun port framing flush to the bulkhead edges - STOP. You will not be able to avoid reducing the thickness of the bulwarks as you sand each subsequent framing color. But your goal should be to reduce that thickness to no less than what is required before planking begins. The bulwarks should end up being 3/32" thick below the cap rail and 1/8" thick at deck level. See the photo below that shows all of the vertical gun port frames completed on the starboard side.

The red frames should be added next. These frames will define the top of each sweep port. The sweep ports will be 1/8" high so all you have to do is measure that distance from the port sills (bottom yellow frames) and mark them in pencil. Use the same Basswood strips (3/16" x 1/14") for the red frames. This time however, your bulwark frames should be substantially thinner and this will allow you to turn the frames so the 1/4" side faces outboard. If you

**Marking the locations for the green frames using the template as a guide.**

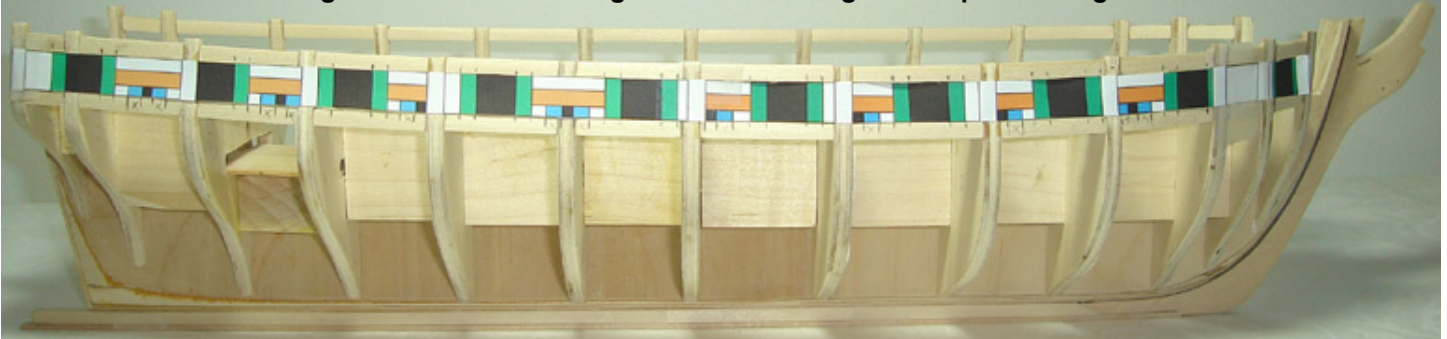

recall, the yellow frames were oriented so the 1/4" side was on top and bottom. This allowed some extra thickness inboard and outboard so you could sand it to the hulls final shape. Such thick frames should no longer be needed so they can be turned the other way. This will fill in more space and give you more surface area to plank over later. The hull will also be much stronger. Bulkhead #8 will have to be cut out like you did earlier to make room for one of the sweep ports. This is shown on the framing template. Use the fine-toothed saw blade like you did earlier when you removed a portion of bulkhead 24.

The last frames to be added in this chapter are the blue ones. Use the framing templates again to locate their position on the hull. Line the template up with the gunports you just finished framing. Then mark the locations for the blue frames on the hull with a pencil. These frames will define the sides of each sweep port. Once again you can use the 1/4' x 3/16" thick Basswood strips. However there may be times where you will have to switch to a thinner wood when these pieces are too large to fit into place. See the photos provided which show the framing for the hull in progress. While you are framing all of the gun ports and sweep ports keep in mind their sizes and measure frequently to keep them consistent . The gun ports are 15/32" wide and high. The sweep ports are 1/8" wide and just as high. The eight sweep ports on each side of the hull are also centered between the gun ports. Make any adjustments required in order to keep them properly positioned and consistent from one side of the hull to the other.

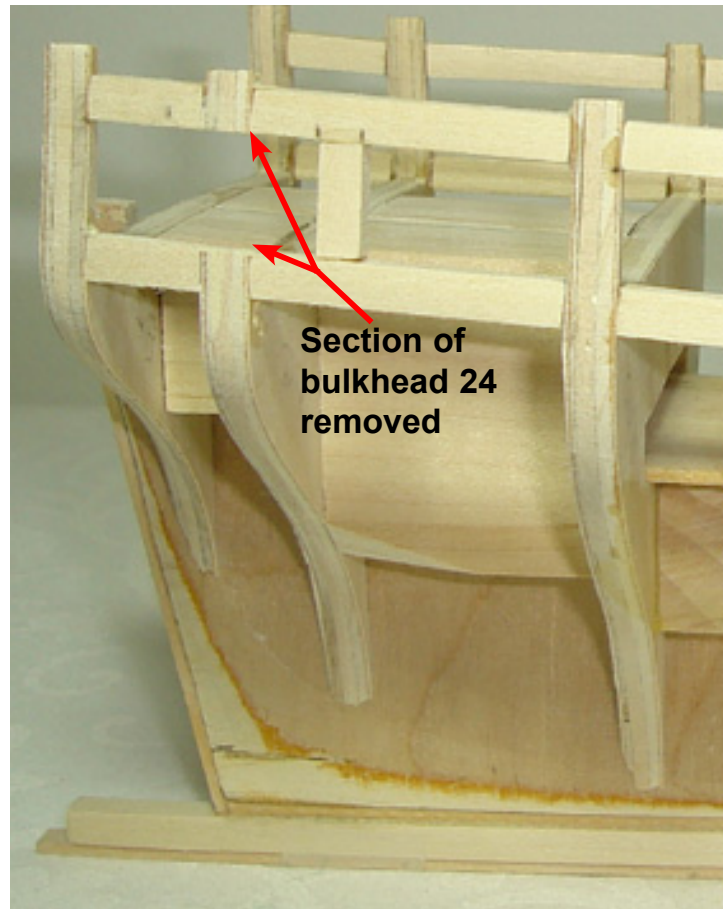

*Cut bulkhead 24 out as shown to make room for the final gunport frame. Note the type of blade used.*



*All of the green frames are glued into place. These frames define the sides of the gunports.*

---

**A Model Expo exclusive! Log on and join Chuck Passaro's Syren forum. Get help and building tips from fellow Syren builders and the designer himself!**

**For more information go to: [www.ModelExpo-online.com/Syren](http://www.ModelExpo-online.com/Syren)**



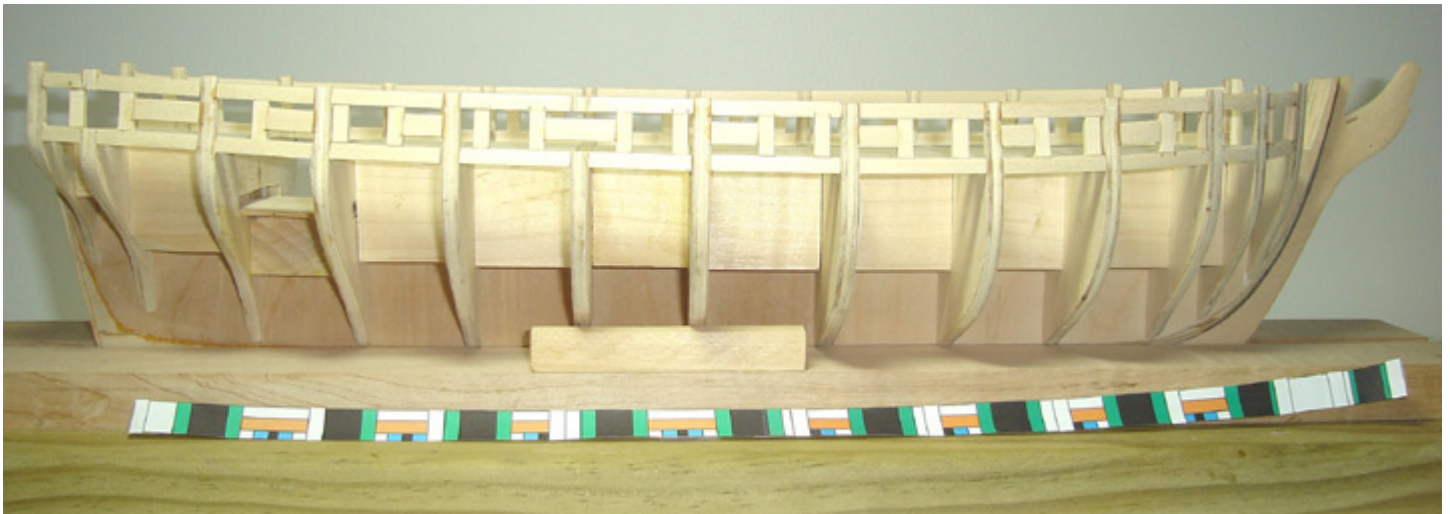

All of the red frames are glued into place. These frames define the top of each sweep port.

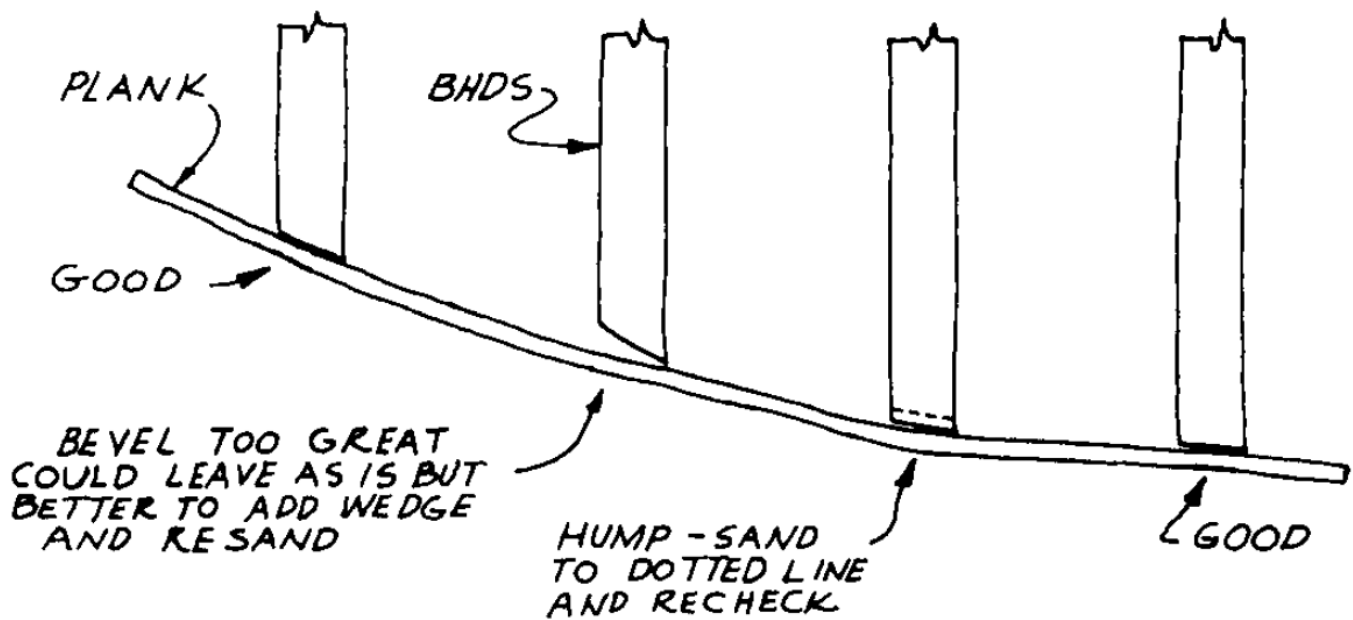
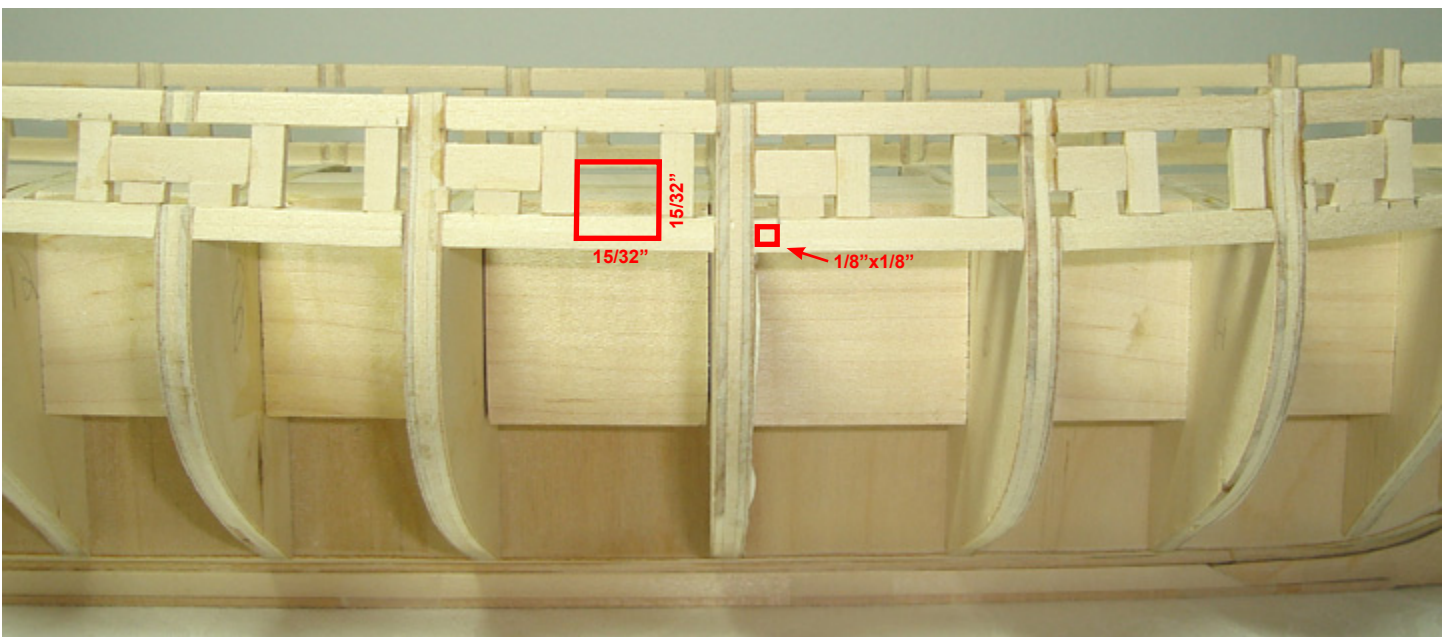

Fairing the bulkheads properly to get the correct bevel angles for planking

Step one

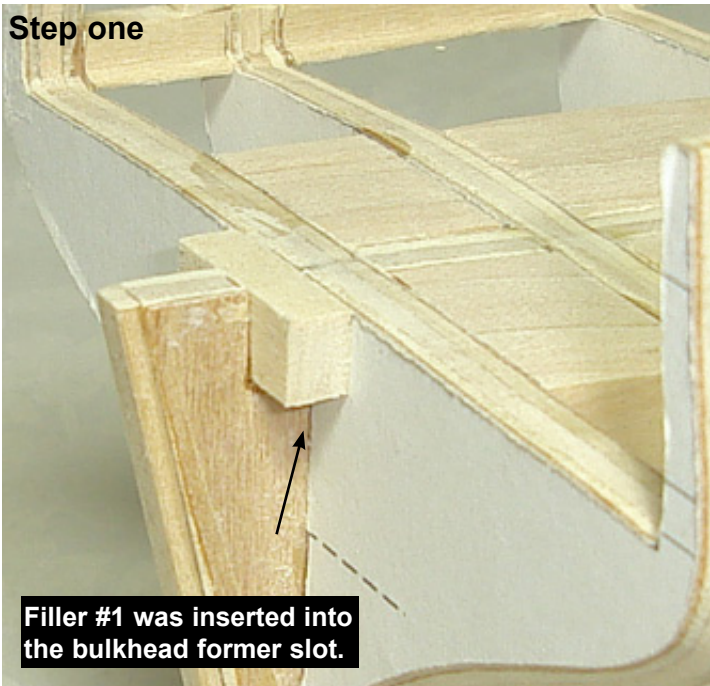

Step two

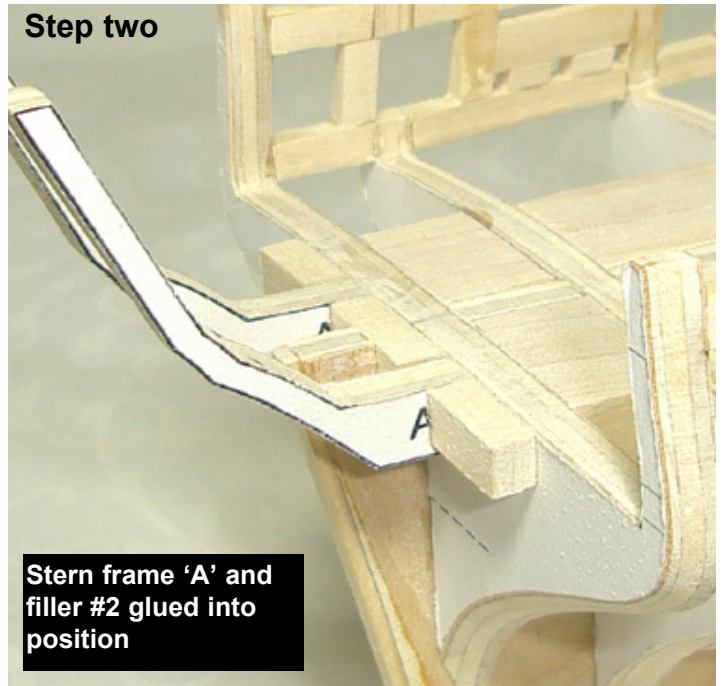

## Chapter Four - Stern Framing

A stern framing template has also been provided for you. It is color coded just like the gun port templates in the last chapter. Framing the stern of any ship model can be a challenge. The stern framing for the Syren has been simplified for you and step-by-step instructions will guide you through the process.

**Step One** — Use a 1/4" x 3/16" strip of Basswood and cut stern filler #1 to the length shown on the stern framing template. Be certain that these filler pieces are cut to their proper length. These pieces will determine the overall width of your stern ports.

Place filler #1 into the slot in the bulkhead former just behind bulkhead #26. Each filler piece should be set flush

to the top of bulkhead #26 as shown in the photo provided. Filler # 1 should be centered (side-to-side) in the bulkhead former slot. This will ensure that the entire stern assembly is centered once it is completed.

**Step Two** — Glue stern frame 'A' to the side of filler #1. There are two frames marked "A". One is glued to each side of filler #1. Once again these frames are set flush to the top of bulkhead 26. Once they are dry, glue the fillers (#2) to the sides of each of those frames. Measure their lengths precisely (1/4" x 3/16").

**Step Three** — Repeat this process again. Glue stern frames 'B' into position followed by fillers #3. Finally, glue

Step three

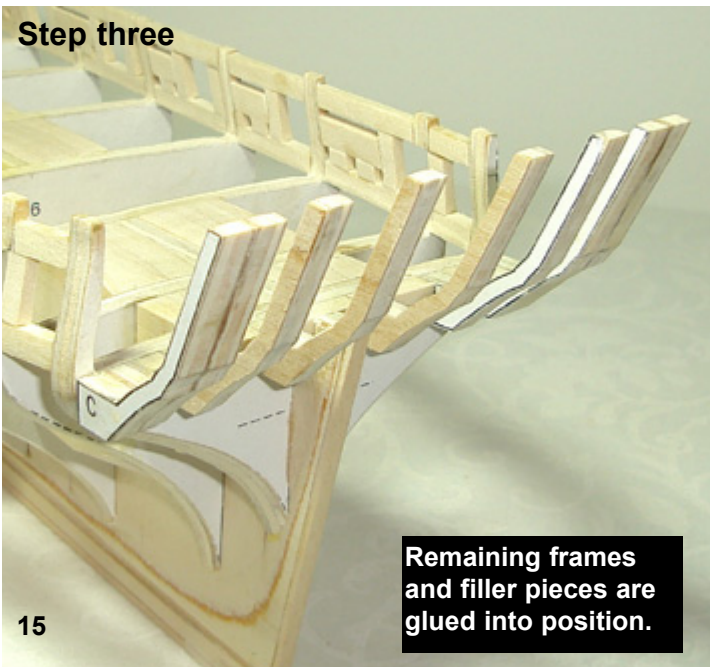

Step four

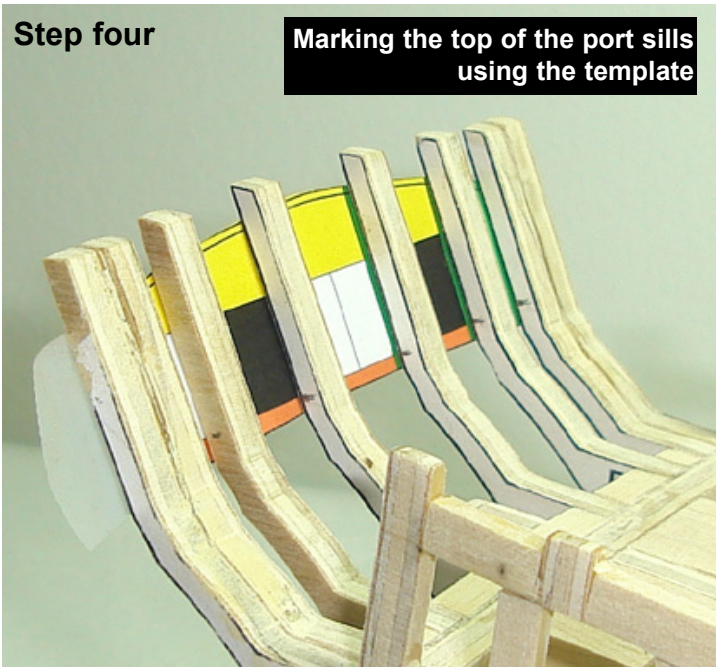



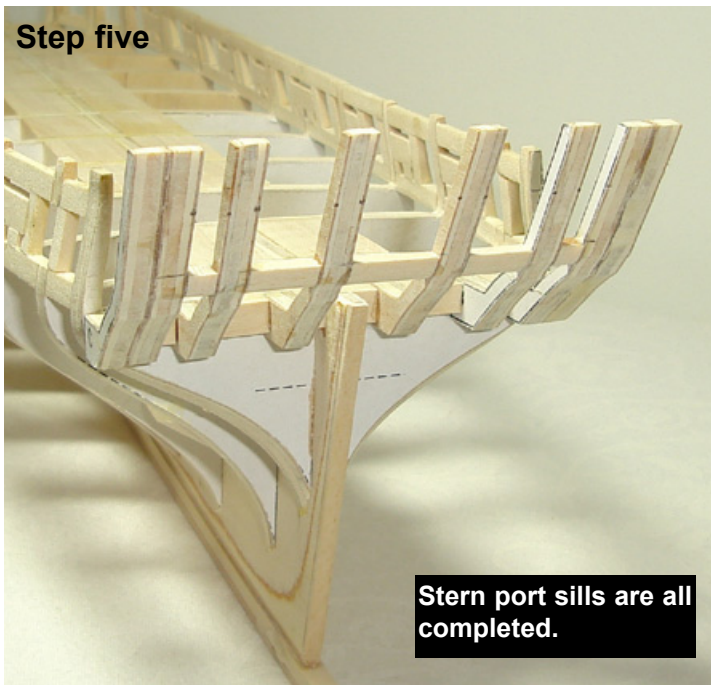

frame 'C' into position alongside those filler pieces. You will notice that frame 'C' was doubled in thickness. You should have four frames marked 'C'. Double them up before you glue them onto the model. At this stage be very, very careful because the stern frames are delicate. They can break quite easily but the next few steps will strengthen the whole stern assembly.

**Step Four** — Cut the stern template out with a sharp blade. Cut it along the line that represents the top of the upper counter. Tape it to the stern using the frames as a guide to line it up. This is a good way to see if the ports will be properly positioned later. Tape the template into position so the frames face inboard. Use a pencil to mark the top of each port sill (red) on the sides of each stern frame. See the photo provided. There are also some laser

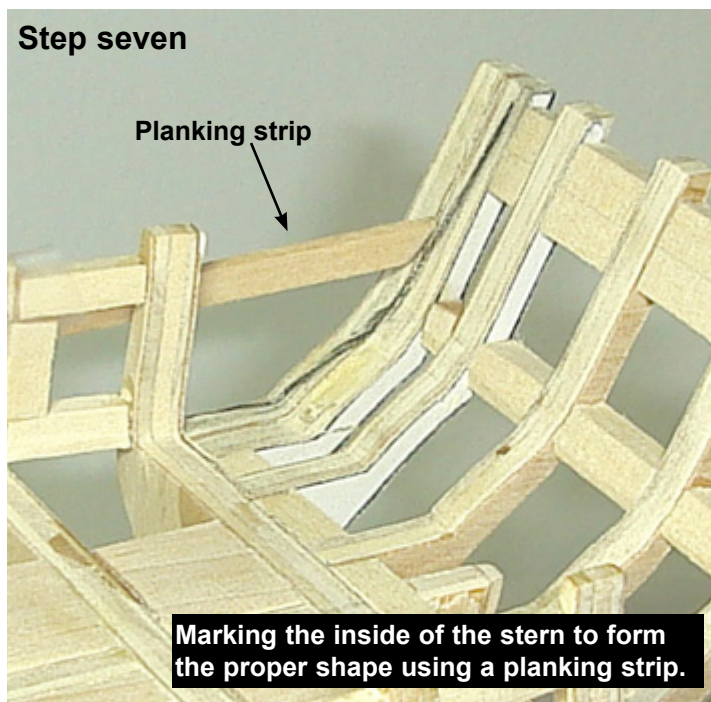

### Step seven

Planking strip

Marking the inside of the stern to form the proper shape using a planking strip.

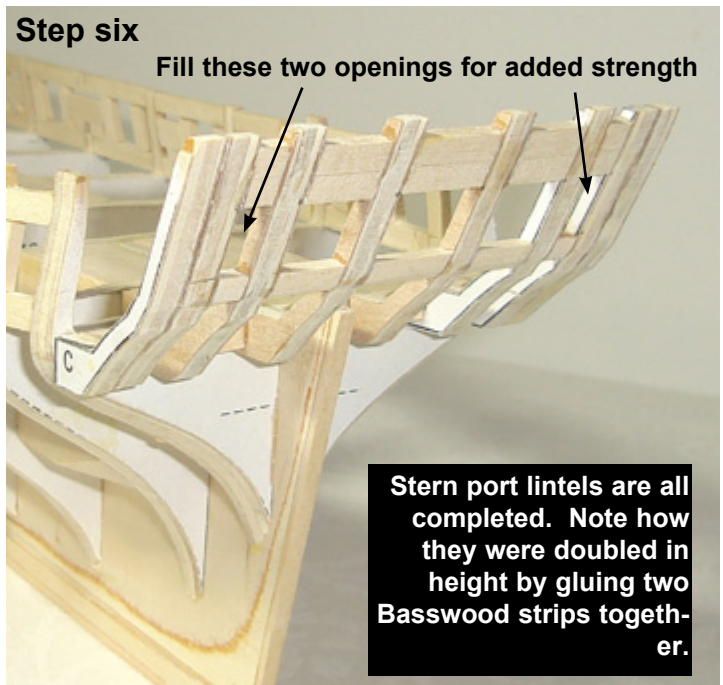

### Step six

Fill these two openings for added strength

Stern port lintels are all completed. Note how they were doubled in height by gluing two Basswood strips together.

scribed lines on each stern frame to help you establish the top of the port sills.

**Step Five** — Cut the port sills to length using  $3/16"$  x  $1/4"$  strips of Basswood and glue them into position. Glue them between each stern frame. Make sure the top of each sill is flat (the same way you framed the gun ports along the sides of the hull). Sand the port sills flush with the outside and inside of the stern frames. This sanding will actually fair the stern to shape. The stern actually has a slight curve to it when viewed from above. Your frames will actually get thinner in the process so be extremely careful while you are sanding. Double check that the 2 pound cannons will fit and your sills are not too high. Remember that the deck will be  $1/16"$  thick and you can place a copy of the cannon into position to see if the ports are the correct height.

**Step Six** — Measure  $15/32"$  up from the port sill to find the locations of the lintels. The stern ports should end up being the same height as those along the sides of the hull ( $15/32"$  x  $15/32"$ ). Glue the lintels (yellow) into position after cutting them to length. The lintels should be cut from a Basswood strip that is  $3/8"$  x  $1/4"$ . Simply glue two of the  $3/16"$  x  $1/4"$  strips together (edge-to-edge) in order to get a strip the correct height to use.

**Step Seven** — You will have to establish the correct shape of the stern on each side of the hull to facilitate the outer planking. To do this, hold a planking strip against the side of the hull. The hull should be faired properly at this point. You will notice in the photo that the end of the planking strip has been angled so it lays flat along the inside of the stern. As you slide the strip down the hull you can see how it captures the shape of the hull on the inside of the stern. Use a pencil to transfer this shape onto the stern as shown. After you create this reference line on both sides of the stern (P & S) you should notice the consistency in their shape and positions.



**Step Eight** — Before you remove the excess material it is recommended that you fill the two openings on the outside of each stern port. It will strengthen the stern even more. Remember it is quite fragile. Then sand the sides of the stern down to your reference lines. If you have a rotary tool, use a sanding drum to quickly remove the excess material. Only sand it part way to the reference line. These power tools can sand away a lot of material quickly and it is better to do the final shaping by hand. The stern assembly should be faired to accept the hull planking and can be checked for accuracy just like the hull itself.

Run a plank across the hull at different levels checking to see that it lays flush against the edge of the stern. Keep sanding until you are satisfied the plank will run smoothly around the “tuck” of the stern. This is the area where the hull planking butts against the lower counter at the sides. See the photos provided that show the stern on the prototype after it was faired for planking.

**Step Nine** — Some filler pieces will be added below the counter so you will have a surface to glue your hull planking to. You can use a solid block or you can use two strips of the 1/4" x 3/16" strips glued on each side of the hull. The later is shown in the photo provided. The strip under the counter should be set flush to the edge of the counter. The strip down the bulkhead former should be positioned so the rabbet strip is still raised and visible from the side. Examine the photo closely for their positions.

**Step Ten** — Sand the filler blocks or strips to shape until a test plank lays flush against them. This procedure can take some time because of their location under the counter and against the bulkhead former. Take your time shaping

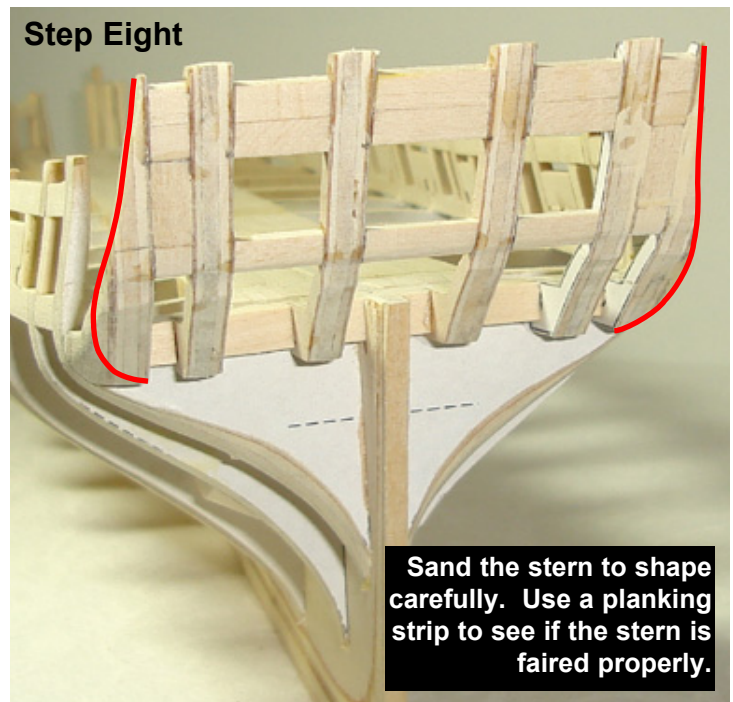

these pieces as it will make your planking that much easier if faired properly. You can turn the hull upside down and it will be easier to shape them. However you should place some blocks under the deck to prop the stern and stem up. Don't let them rest on your work table because they may break under the pressure of your carving and sanding.





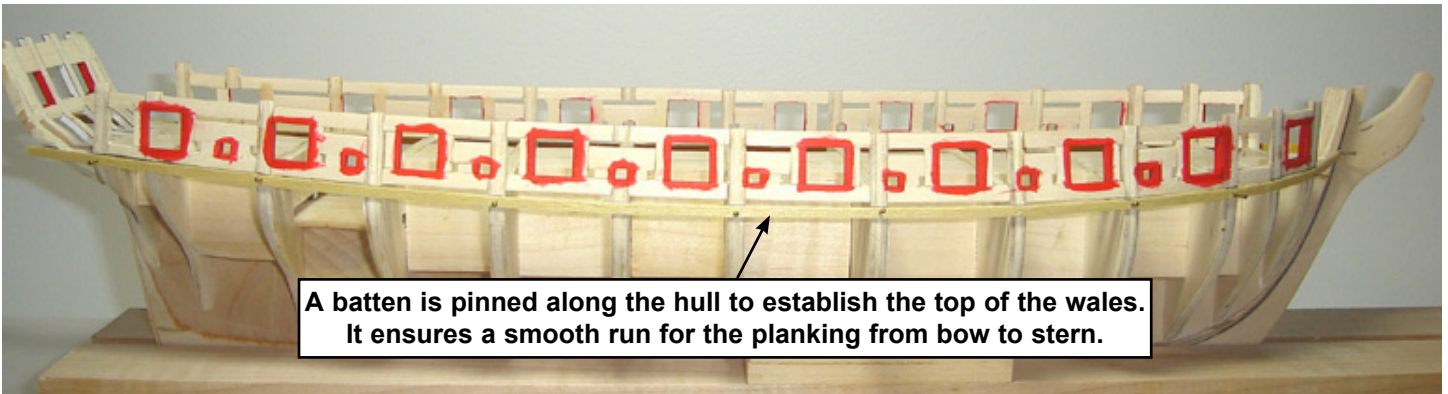

A batten is pinned along the hull to establish the top of the wales. It ensures a smooth run for the planking from bow to stern.

## Chapter Five Hull Planking

This model of the Syren will be planked with a single layer of 1/16" thick planking. The Syren is not a project for the first time model builder and therefore it can be assumed that most of you have some planking experience. However experienced you may be there is a book available at [www.modelexpo-online.com](http://www.modelexpo-online.com) that discusses planking techniques in great detail. "PLANKING THE BUILT-UP SHIP MODEL" by Jim Roberts. It is a step-by-step procedural guide to the historically and technically correct methods of planking ship models. It is highly recommended. There have been many other books and articles written about how to properly plank a ship model. One of those methods is described here, however it is understood that most model builders have a preferred personal method for planking. Choose the technique that works best for you.

It will be easier to plank the hull if you break this task down into smaller incremental steps. Before you begin planking however, it would be a good idea to paint the inside of each gun port and sweep port. You may opt not to paint any of the model and simply leave it a natural wood finish. The choice is yours. Should you decide to paint the bulwarks and port openings, then red would be an appropriate choice. This was a typical color chosen during that time period. It shouldn't be a bright fire engine red. It should be a muted brownish red/maroon. The photos provided show the insides and outboard frames around the ports painted before the planking was started.

**STEP ONE** — As done earlier, use a batten to establish the proper, smooth run of your planking from bow to stern. Each bulkhead has a reference line on it that represents the top edge of the wales. Run your batten across the hull and pin it temporarily into position. The top edge of the batten should lie against the reference marks. View the batten from many angles to ensure it has no unsightly dips. When you are satisfied do the same on the other side of the hull. Placing the battens on both sides now will give you the opportunity to inspect them from the bow and the stern. The battens should have a symmetrical appearance and the sloping angle as they run down the hull should be consistent and smooth. See the photo provided. Once you are satisfied you can mark the outside edge of each bulkhead along the top of the batten. Remove the battens afterwards. You will notice that the run of the planking *DOES NOT* follow the run of the gun ports across the hull. This is not an error. The planking will not follow the run of the gun ports.

The first planking strip placed on the model will be the upper wale. The planking strips for the wales are wider than the other hull planking you will be using. They are 5/32" wide x 1/16" thick. The wales will consist of three rows of planks on each side of the hull but only the upper most row will be positioned in this step. These 3 rows will also end up being thicker than the other hull planking but once again this won't be done until later. You will eventual-

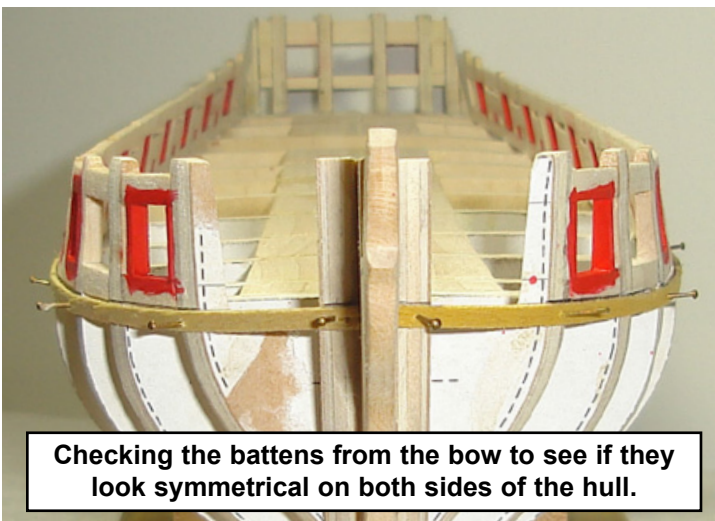

Checking the battens from the bow to see if they look symmetrical on both sides of the hull.

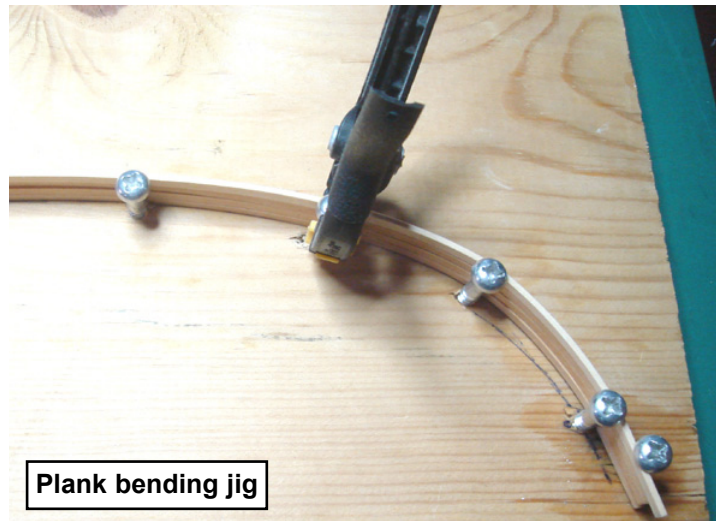

Plank bending jig

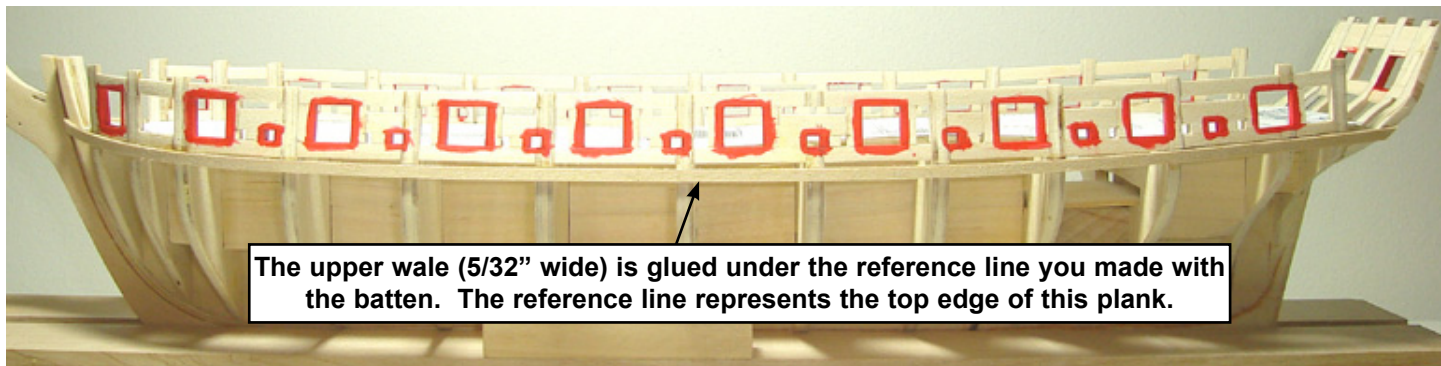

**The upper wale (5/32" wide) is glued under the reference line you made with the batten. The reference line represents the top edge of this plank.**

ly place another layer of planking over the top of the wales to make them thicker.

Take a strip of 5/32" wide planking and soak it in warm water. This will help soften the wood and allow you to bend it around the bow and into position. One widely used technique is to pre form your planks in a jig before you glue them onto the hull. Take a photo copy of the deck layout and glue it onto a scrap piece of wood. You only need to use the bow portion of the plan. This will give you a guide for the shape of the bow. Insert a few screws along the outside profile and you will have produced a simple jig to pre-form the planking strips. See the photo provided. Soak your planks in water and place them into the jig as shown. Once dry, they will retain their shape and it will be much easier to glue them into position. Glue the plank for the upper wale onto the hull. You should be able to insert the end of the plank into the rabbet at the stem. This will hold it firmly while you position the top edge of the plank along your reference lines.

This first wale plank can be glued across all of the bulkhead edges in one length. Even though the planking on the actual ship would have been done in 20 to 25 foot lengths, this plank will eventually be covered with a second layer and therefore it is not necessary to use smaller segments. Using one length will help you keep the run of the plank smooth and consistent across the entire hull. This is much more important at this stage. The planking above this upper wale will be done in smaller lengths and the butts/joints between them will be staggered as shown on plan sheet one. Note however that the planks between

each port are fastened in one length since there was a short enough distance between them. There should be no plank joints visible between each gun and sweep port.

There will be seven 1/8" wide planks placed above the upper wale. Gluing these planks onto the model will complete 'step one' of the planking process. They should be pre-formed in the jig prior to gluing them. As mentioned earlier the two rows of planking immediately above the upper wale should be cut into smaller segments. They were cut to length on the prototype so each segment would span across four bulkhead edges. This will also be the case for the rows of planking above the gun ports. The top edge of the seventh plank above the wales will delineate the sheer/profile of the hull. This is why it is so important to take your time in establishing the proper run of that first 5/32" plank.

You will be planking from the wales upward. As you progress the strips should be notched out to fit around each gun port and sweep port. You can use a sharp #11 blade in your hobby knife to cut these notches. See the photo provided. You should not cut the planking so it is flush with the edges of each port. There should be a small lip or ledge remaining around each port. This forms a rabbet which helps the port lids form a water tight seal when closed. This lip should be less than 1/32' wide around each port. It would have been around 1 1/2' wide on the actual ship. This detail is often overstated on many ship models. Anything wider than 1/32" would be greatly over scale. A corresponding lip will be created on the inboard edges of each port lid so it fits snugly when closed. The

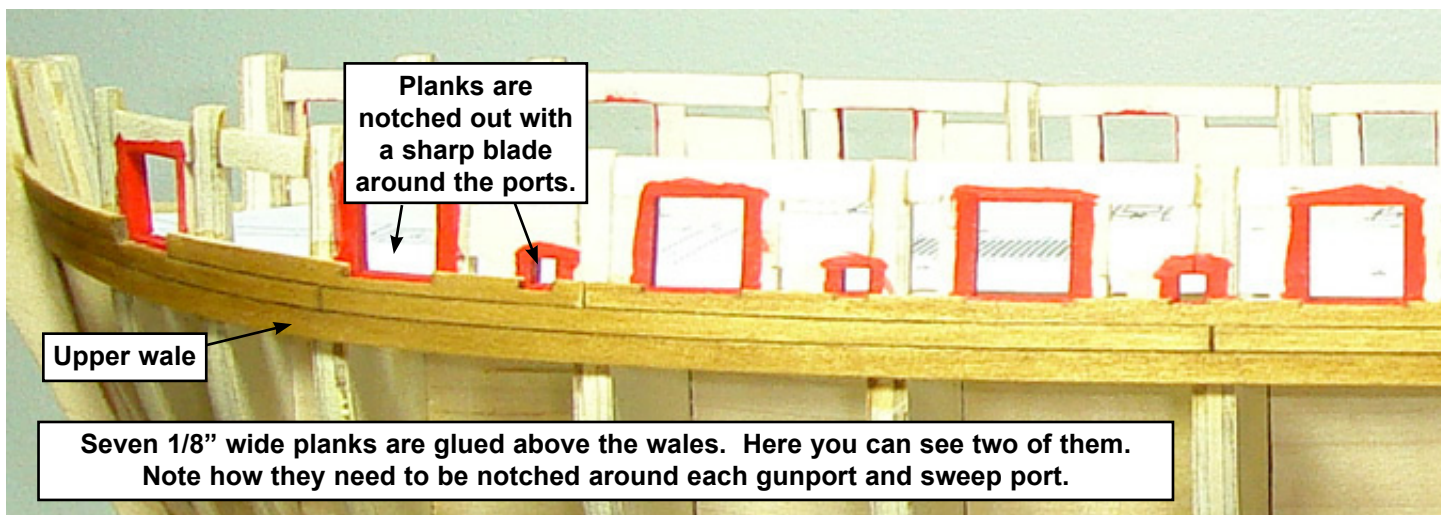

**Planks are notched out with a sharp blade around the ports.**

**Upper wale**

**Seven 1/8" wide planks are glued above the wales. Here you can see two of them. Note how they need to be notched around each gunport and sweep port.**



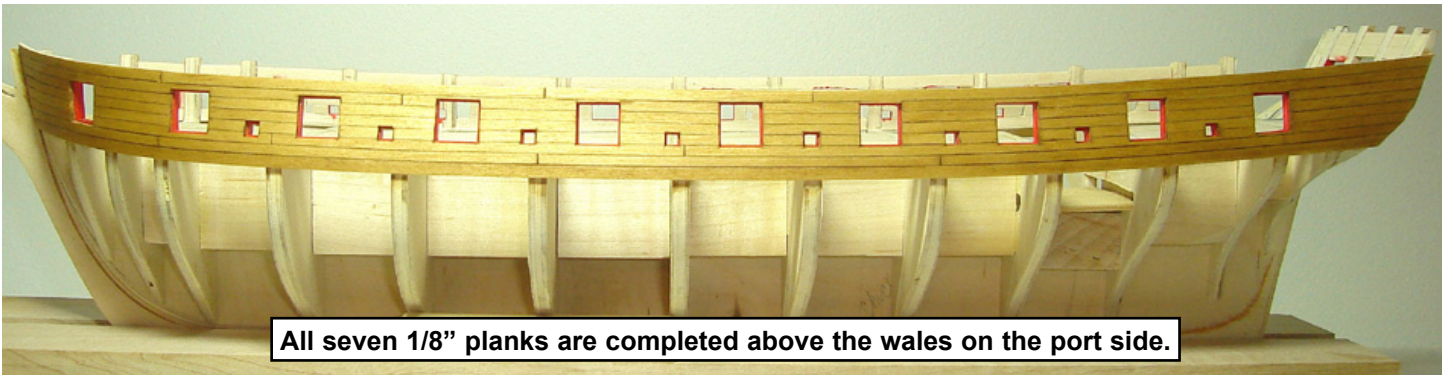

**All seven 1/8" planks are completed above the wales on the port side.**

planks along the top of each port should be notched as well. This can be a tricky process. Hold the planks in position and mark the locations to be notched out with a pencil. Treat each planking segment as a small project unto itself. There is no need to rush through this process. A poor planking job here can ruin the appearance of your model. If you aren't happy with how a plank segment fits after you finish cutting it to shape, then throw it away and make another one. As you finish a few of them you will see the results getting better and better.

On the real ship, the sides of the hull would have been painted dull yellow ochre above the wales. The prototype model will be stained with MinWax Golden Oak stain to simulate this color. However, you may opt to paint the hull instead. If you do decide to stain the hull planking, you can add many other details to your model. One of these details would be to emphasize the seams between each row of planking. The seams between them were caulked to make them water tight. Many techniques are used to simulate this caulking. A pencil was used to darken one edge of each plank before it was glued onto the prototype. This creates a more subdued seam but other materials can be used if you prefer a more prominent look. The planking was also fastened to the hull framing with wooden pegs called treenails. These will be simulated in a later planking step. This is another detail that can be added to your model should you decide to stain it rather than paint it above the wales.

The wales will eventually be painted black in addition to all of the planking down to the waterline. Below the water line the hull is copper plated so there is no need to simulate the caulking or add treenails there. There are many ways to finish your model and all of them produce a very different look and style. Trying different finishes and techniques on some planking mock-ups can help you find a result you can be happy with. Try planking several small swatches on some scrap wood so you can experiment a little. The techniques used on the prototype will be explained in more detail later as we progress through the planking process. See the photo provided showing all seven planks above the wale completed. Once you have done so on both sides of the hull you can move ahead to step two.

**STEP 2 -** Before any additional planking is completed on the sides of the hull, the counter at the stern should be planked over first. Seven planks will be needed to cover the upper and lower counter. However you should double check that the height of your two stern ports is correct before you start planking. This will be the last opportunity to ensure they are correctly positioned. Once the counter is planked and the transom is glued into position it will be very difficult to adjust them. The picture on the next page shows a photocopy of the long 12 pounder cannons taped to a 1/16" thick planking strip. The deck will be 1/16" thick and this plank will simulate the correct thickness. Position this cannon cutout on deck so the barrel of the long gun





fits through each port opening. If the ports are too high you should remove the sills and lintels and reposition them so the cannon cutout fits. It shouldn't be too difficult to pop them out should you need to.

When you are satisfied with the port positions you can place the first planking strip along the upper counter. The first planking strip will be 5/32" wide and 1/16" thick. This is the first plank below the gun ports. The plank should be placed 1/16" below the top of the stern port sills. Below this, 6 additional planks (1/8" wide) are glued into position. See the photo provided. Note how both sides of the planks were sanded flush to the shape of the counter. The counter on the prototype will eventually be painted black. If you decide not to paint your model then you can simulate the caulking between the planks as discussed earlier.

Remove the transom from the laser cut sheet. You will notice that the openings for the two stern ports have not been cut from the transom yet. Since every model will vary slightly, it is more accurate to take those measurements directly from your hull. To do this, simply tape your transom into position along the top edge of the counter. You may have to bevel the bottom edge of the transom so it rests properly along the top of that 5/32" wide plank. Be sure to center the transom properly. The sides of the transom will extend beyond the sides of the hull by about 1/16". Once in position, trace the port positions onto the transom from the inboard side.

The transom is thin enough that you should be able to cut the ports out using a sharp #11 blade in your hobby knife. Remember to cut just outside of your reference lines so your port openings are slightly larger than drawn. You want to create the rabbet around each port so the lids will be water tight when closed. This exposed "lip/edge" should be the same size as you created them for the gun ports along the sides of the hull. Test the transom periodically to see if the ports line up and make any adjustments until you are satisfied. Then glue it into position. Finish step two of the planking process by sanding the stern

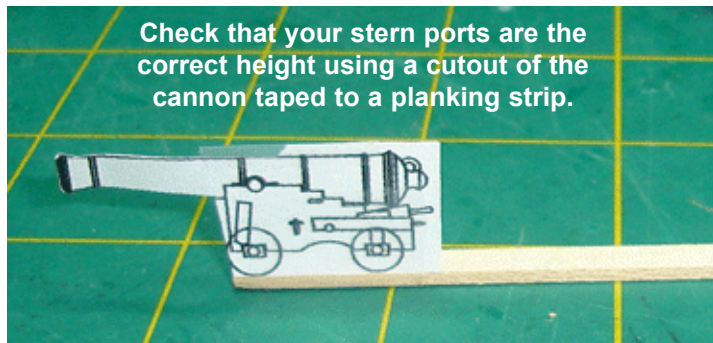

Check that your stern ports are the correct height using a cutout of the cannon taped to a planking strip.

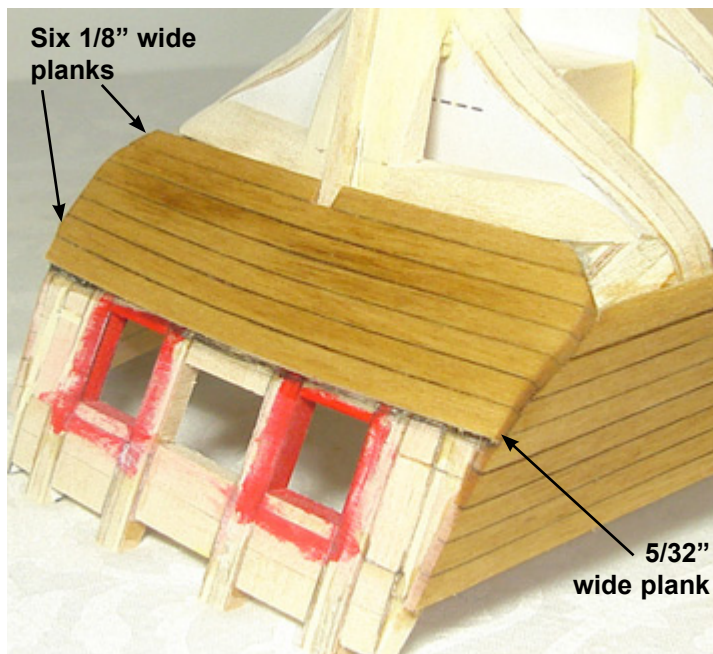

Six 1/8" wide planks

5/32" wide plank

frames down to match the curved profile of the transom. See the photos provided.

**STEP 3** - Work can now continue on planking both sides of the hull. In this step we will add three planks along the keel and three more planks just below the upper wales. These planks will define a large unplanked area between them. In step four you will measure, divide up and create a "planking-plan-of-attack" to complete this area.

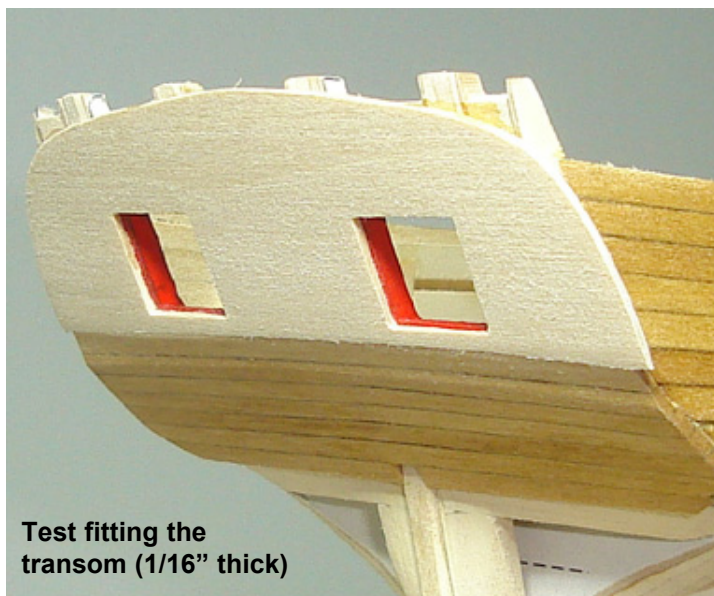

Test fitting the transom (1/16" thick)

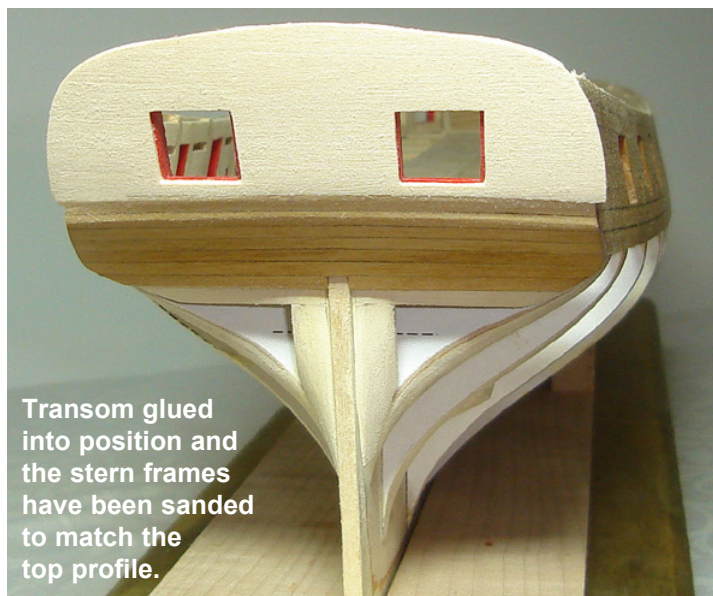

Transom glued into position and the stern frames have been sanded to match the top profile.



Three planks were added below the existing planking. The first two finish the initial layer for the wales. They are  $\frac{5}{32}$ " wide. The last one is  $\frac{1}{8}$ " wide.



The first three planks continued under the wales will consist of two  $\frac{5}{32}$ " wide planking strips. These two strips will complete the initial layer of the wales which are wider than the remaining planking. When finished there should be three  $\frac{5}{32}$ " wide planks on the hull that represent the wales. Under these, a final  $\frac{1}{18}$ " wide strip is added. See the photo to the right.

Three more planking strips will be added along the keel. The first is the "garboard plank". This plank will be  $\frac{3}{16}$ " wide and  $\frac{1}{16}$ " thick. See the photo below. Note how the forward edge of the garboard plank is shaped to fit into the rabbet at the bow. The tip of the garboard plank should not extend past bulkhead "N". You can see this clearly in the photo. Two more  $\frac{1}{8}$ " wide planks are added as shown to complete step 3. If you are going to cover the bottom of the hull with copper plates or paint it, then there is no need to simulate the caulking between each plank. You can also run the planks from bow to stern in one length rather than cut them into segments and stagger the butt joints. All of that extra work will eventually be covered up any way. Cut the planks flush with the edge of the rabbet strip at the stern.

In order for these three planks to lay properly across each bulkhead without twisting, you may have to clamp them down or temporarily pin them to each bulkhead edge so they don't shift and twist before the glue dries. Soaking the planks first will help make them more pliable.

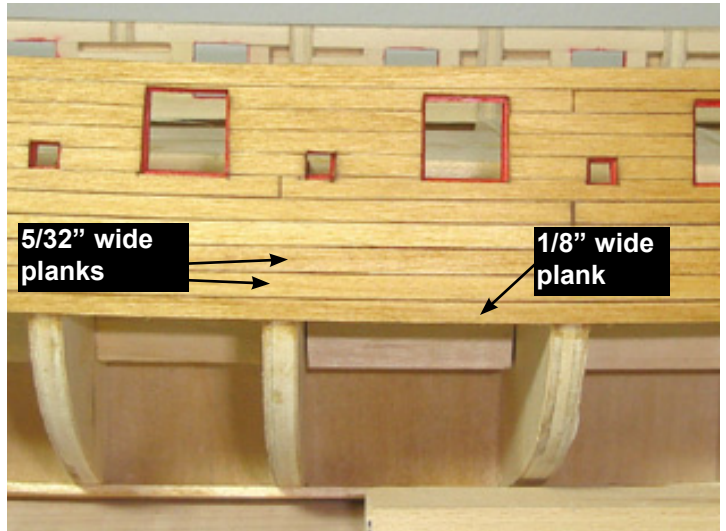

**STEP 4** - Step four requires that you use a tick strip to measure the remaining gap in the planking. See the photo on the next page. Measure the size of the gap at the center bulkhead. Take that measurement and divide by  $\frac{1}{8}$ ". Your answer will be the number of  $\frac{1}{8}$ " wide planks needed to fill that space. You will see that it will require 22 or 23 planks. Every model will vary slightly but that should be the number you come up with.

Keep mind that you will experience what is called "creep". Creep occurs when the thickness of the glue between planks, along with not butting the planks tightly together

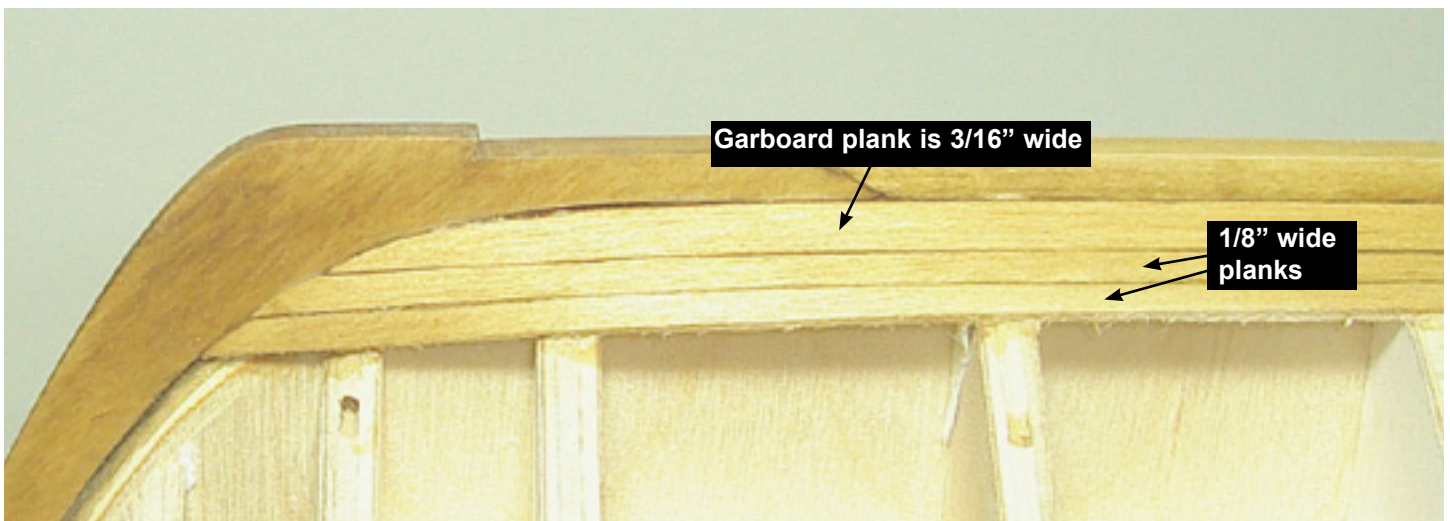



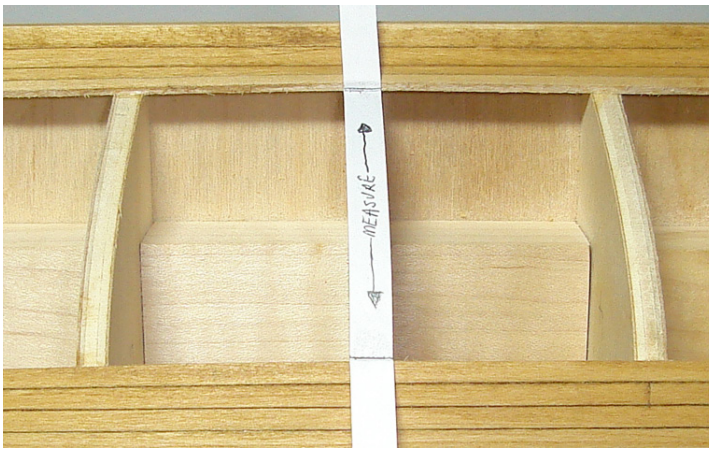

cause the 22 strips to take up more area than you originally thought. It will happen. Because of “creep” you may use fewer planks than anticipated. Even so, this will help you create a plan for planking the hull.

Then measure the size of the gap at bulkhead “N” and divide that by 22 or 23 strips. The answer you get will be the width those 22 strips need to be tapered to. The planks at the bow will be tapered to around  $3/32$ ” wide (give or take). Taper about 5” at the end of each plank. They should gradually taper from  $1/8$ ” wide to whatever measurement you came up with. Tapering all of your planks at the bow should prevent you from having to create any drop planks or plank inserts. See the illustration on the next page.

The stern is handled a little differently. Measure the distance along the stern post and under the counter. Divide that by  $1/8$ ”. You will come to realize that it will take many more planks than 22 to cover that area. Probably around 27 planks total. This means there will be 4 or 5 stealers needed in addition to the 22 planks used at mid ship. If you account for “creep” or use a few  $3/16$ ” wide planks fewer stealers will be needed.

By measuring and pre-planning it will make your planking go much easier. Some model builders also split the area to be planked into three bands (bow to stern). These planking belts can be defined by pinning temporary battens across the bulkheads. Then you can attack each planking belt one at a time. Once you have developed a planking

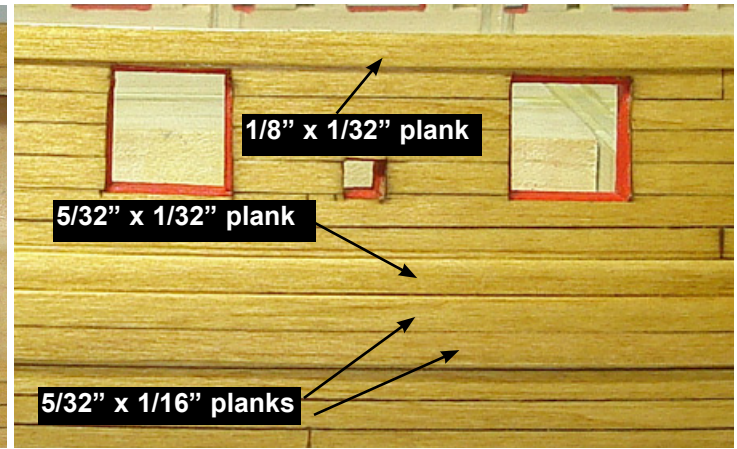

plan, you can complete step four by adding 3 or 4 more planks to each side of the hull. But don’t plank over the entire hull just yet.

**STEP 5 -** Before completing all of the planking it would be a good idea to take advantage of the exposed bulkheads. If you are planning on treenailing the stained areas of the hull above the wales the bulkheads will help you keep the rows of treenails straight and parallel to each other. Treenails were wooden pegs that helped secure the planks to the ship’s frames. There were also wooden plugs that covered recessed bolt heads. Simulating this look will add some great texture and richness to your model..

Start by adding the second layer of the wales and sheer strake (the top-most plank that defines the sheer of the hull). The lower wales will be  $5/32$ ” x  $1/16$ ” thick. The top-most wale will be thinner at  $1/32$ ” thick. See the photo above. Finally the second layer of the sheer strake can be added which is  $1/8$ ” wide and  $1/32$ ” thick. Glue these directly on top of the first layer following their run from bow to stern. See the small diagram in the upper left corner of plan sheet one for more planking information.

For the treenails: Draw some vertical lines on the planks between the wales and sheer strake. These lines should follow the center of each bulkhead edge. Having the bulkheads exposed will help you keep them straight and uniform. Between each numbered and lettered bulkhead there would have been additional, evenly spaced frames on the real ship. These are the numbers and letters not

**Second layer of the wales and the sheer strake have been added to the model.**





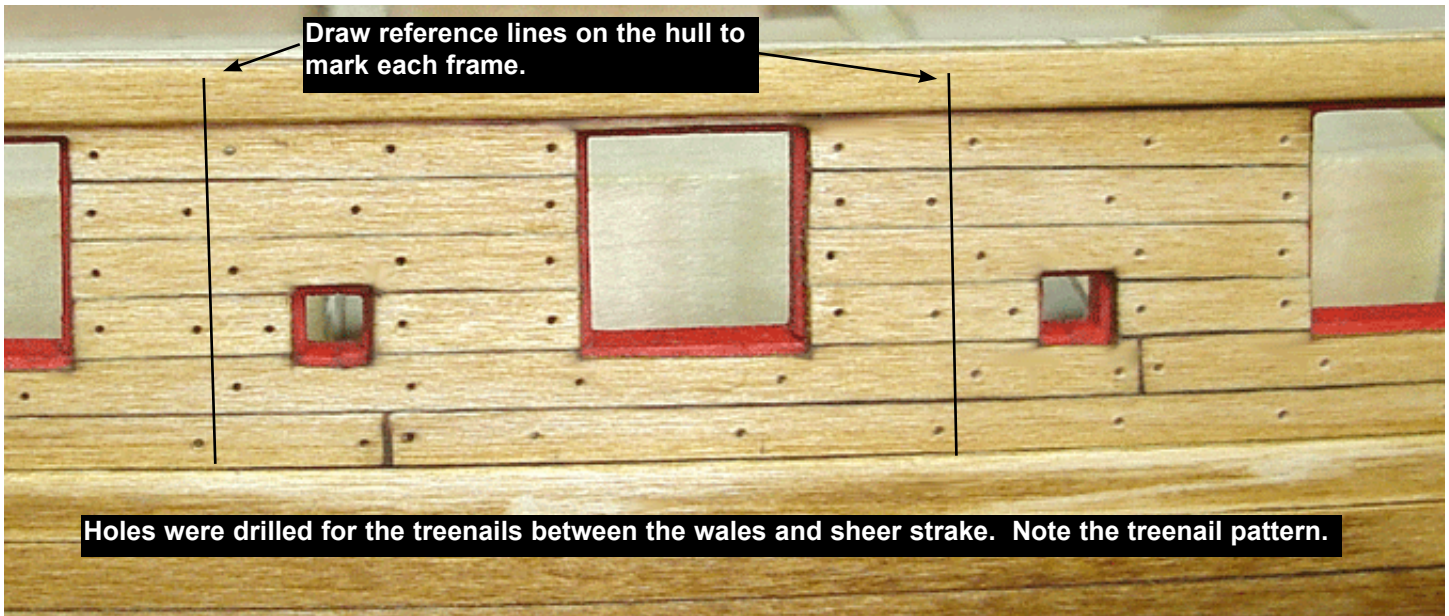

shown that would fall between those listed on plan sheet one. Draw vertical lines for these as well. Drill holes for the treenails in the pattern shown above. You should stagger the holes (one on each plank) on either side of the reference lines as you work your way down the hull. Additional holes should be placed on the ends of each plank where they butt against a port opening.

There are several ways to create the treenails that will fill these holes. One method would be to pull small strips of wood through a metal draw plate. The holes in the draw plate would get progressively smaller. You would pull the wood through many holes working your way to the smallest so the strips will fit into the tiny treenail holes. Place a small amount of watered down white glue onto the end of the small wooden treenail and insert it into each hole. Then snip it off close to the hull with a nail clippers. When all of the holes are filled, sand the treenails down flush with the hull. Stain the entire hull to finish it up. This method works well but can be very time consuming.

Another alternative (which was used on the prototype) would be to fill the holes with some water based wood filler. Then sand the hull down and stain. Elmers wood filler works well for this application. Be careful not to make the treenails too large or too dark. A 0.55 bit was used to drill the holes on the prototype.

**STEP 6** - Complete the planking of the hull. See the photos provided. Soaking the planks and pre-forming them in a jig will help you bend them around the bow. This is also true with the extreme bend around the tuck of the stern. Once the planking is finished apply some wood filler below the wales to fill any cracks and sand the hull smooth.

Draw the waterline from bow to stern. Take the measurements from the plans. Measure the distance from the wales to the water line at the bow and the stern. Then use a water line marker to create a reference line across the length of the hull (port and starboard). You will have

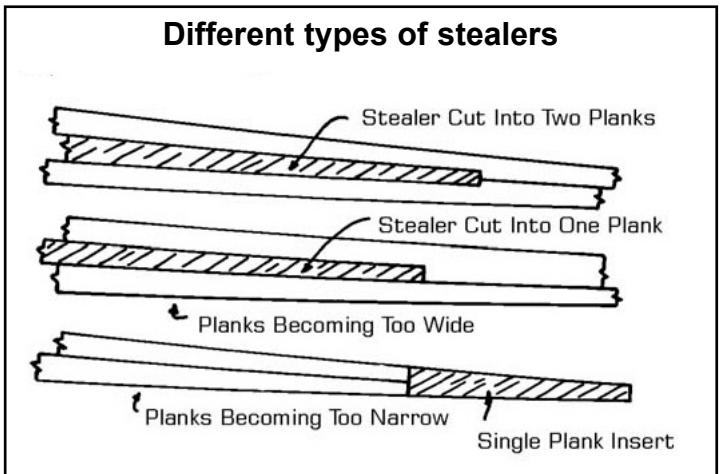



Planking completed on the port side of the model.

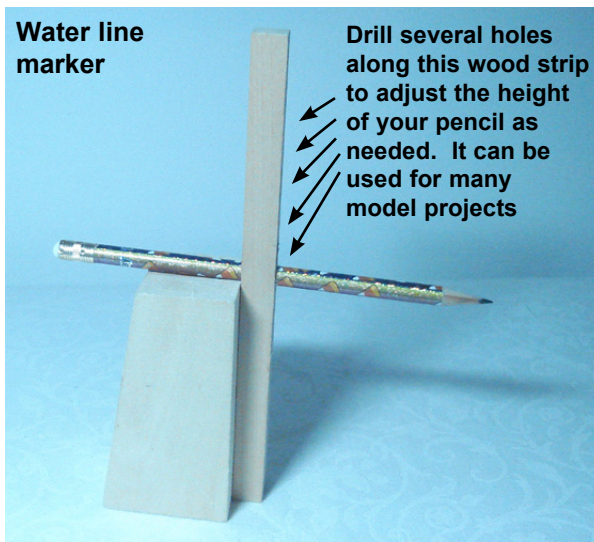
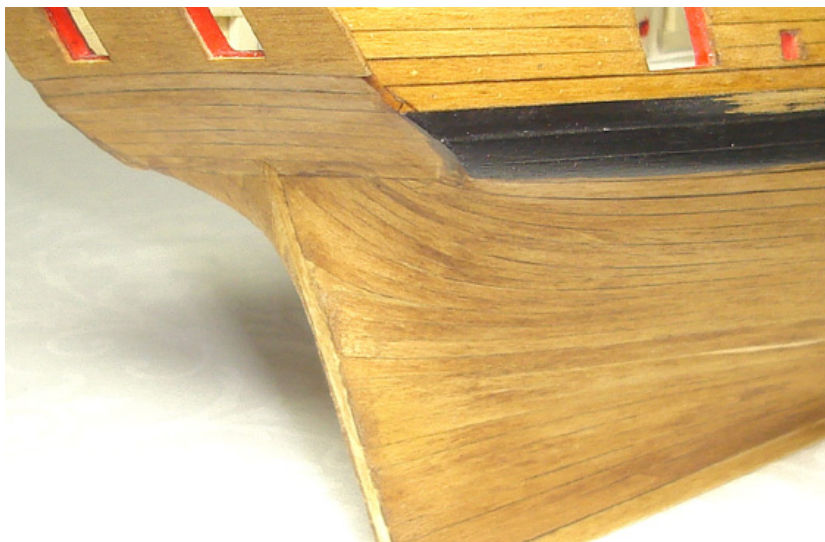

to lift the bow a little bit to achieve the proper angle from bow to stern. The water line angles downward towards the bow. Place your water line marker at the stern so the pencil lines up with your reference mark for the waterline. Then lift the bow by placing some shims under your work cradle until the pencil in your water line marker is level with the reference mark there. Make sure your hull is sitting perfectly flat in its cradle before you begin marking the waterline. Otherwise the water line will be higher on one side of the hull than the other. A typical water line marker can be made with some scrap wood and slid across a flat

surface to create the water line from bow to stern. See the photo above for one such creation.

Add the laser cut stern post (3/16" thick basswood sheet). The template is provided for you on plan sheet 3. Glue it into position as shown on the plans. The keel can be cut to length afterwards but the false keel won't be permanently attached yet until after the hull is plated with copper. Paint the hull black below the wales to the water line. Sand between multiple coats for the best possible finish.





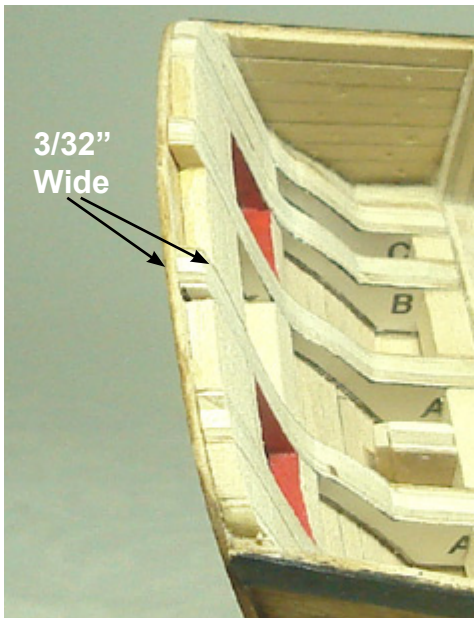

Planked inboard with 1/8" x 1/16" planks from the deck up.

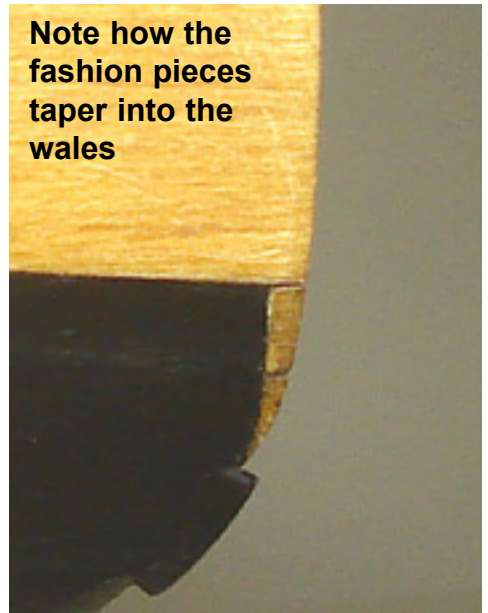
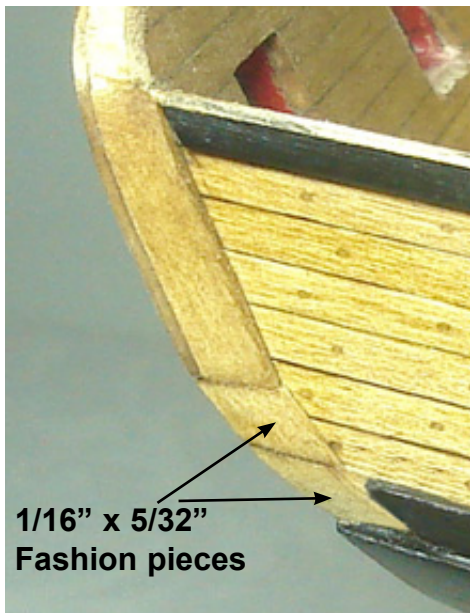
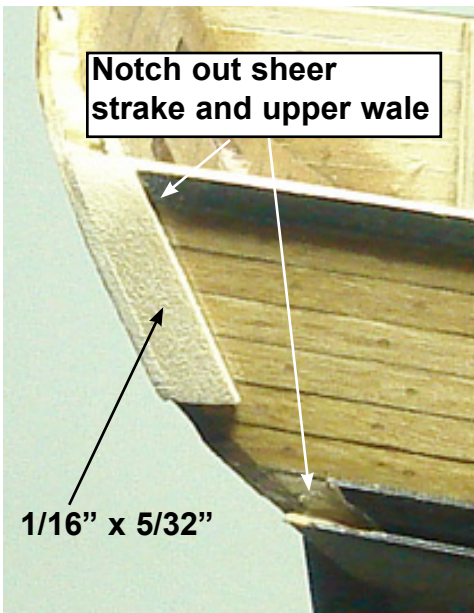
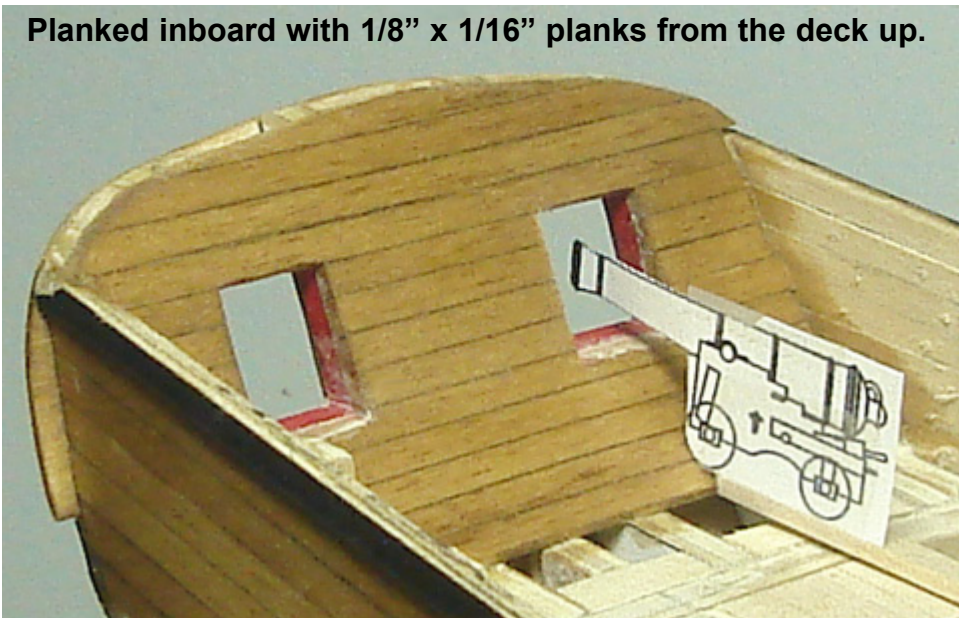

## Chapter Six Stern Construction Continued

Now that the planking is completed you can continue work on the stern. You will complete its construction but before doing so a little preparation is needed. The stern needs to be sanded down to 3/32" thick. See the photo provided above. That is the ideal thickness however anything less than 1/8" will do. It can be sanded inboard and outboard but most of the reduction should be done inboard. Once the stern has been reduced in thickness it can be planked inboard. Use 1/8" x 1/16" Basswood strips. Start at the deck and work your way upward. The planks will need to be trimmed to fit around each stern port just as you did earlier while planking the sides of the hull. This time, however, the planks will be cut flush to the port edges with no "reveal" or rabbet. See the photo above. Paint these planks "bulwark red".

Your stern should be less than 3/16" thick now (Preferably 5/32" thick). The sides of the stern transom, port and starboard, need to be built up as well. To do this, three

pieces of strip wood will be glued to the hull as shown in the photos above. Before doing so, the sheer strake and the upper wale should be notched out to accept them. The first piece should be added to the stern transom as it extends out beyond the sides of the hull. Use a 5/32" x 1/16" basswood strip. Sand it down to match the curved profile of the stern transom. Two more "fashion pieces" are added below it to finish it off. Use the same size wood strips. By cutting them at the angles required, they should end up being the proper width. Note how the fashion pieces taper into the lower wales. This is important because a final "cap rail" will be placed on top of the finished stern assembly later and fit flush with the lower wales. Note that the thickness of the stern here is slightly wider than it is inboard. This is correct as the cap rail will be flush with the forward edge of the fashion pieces unlike inboard where there will be a slight overhang.

The upper counter is defined with two molding strips. Use a 1/16" x 1/16" basswood strip for this purpose. These



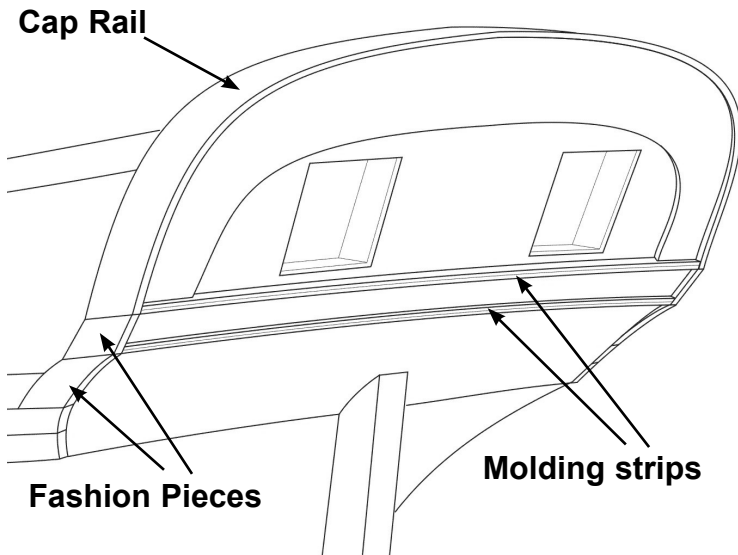

strips may be a little heavy and should be thinned down a little bit with the edges rounded off.  $1/32'' \times 1/32''$  is probably too thin, but something in between would work fine. The area between the two molding strips should be no less than  $1/8''$  wide. Be sure to follow the gentle curve of the transom side-to-side and keep the space between them consistent.

The second laser cut transom layer can be placed so it sits on top of this molding. This transom layer was designed a little taller than needed to give you some extra room to sand it properly. At this stage your stern should be  $3/16''$  thick. On the port and starboard sides of the hull where the stern extends beyond the hull (including the fashion pieces) it is a little thicker at  $7/32''$ . This is because the forward edge of the cap rail will have no overhang there.

To complete the construction of the stern, the cap rail can be formed to fit on top of the transom. Use a Basswood strip that is  $1/4'' \times 1/16''$ . Soak the strip and tie it around the transom to pre-form its shape. Proceed slowly while bending it. If you bend it too quickly it will most likely break. It is easier to glue the cap rail on top of the stern if it is done in two pieces. Cut the strip in half. (one each for the port

and starboard sides). This cap rail will extend down the sides of the transom until it meets the two fashion pieces you added earlier. Two more separate pieces will be shaped as a second layer for both of these. They will need to be cut to their proper angles as you did for the first layer. The cap rail should overhang the stern inboard and outboard just a little bit. However on the sides of the hull there won't be any overhang for the forward edge at all which was mentioned earlier (including the two fashion pieces). The aft edge of the cap rail will hang over the transom. As for the second layer of the two fashion pieces, only the top-most piece has an overhang. It will create a slight lip for the upper counter so the two beaded molding strips aren't visible from the sides. The lower fashion piece should be sanded gradually flush with the lower counter. The cap rail and fashion pieces are painted black.

*Stern transom completed and painted*





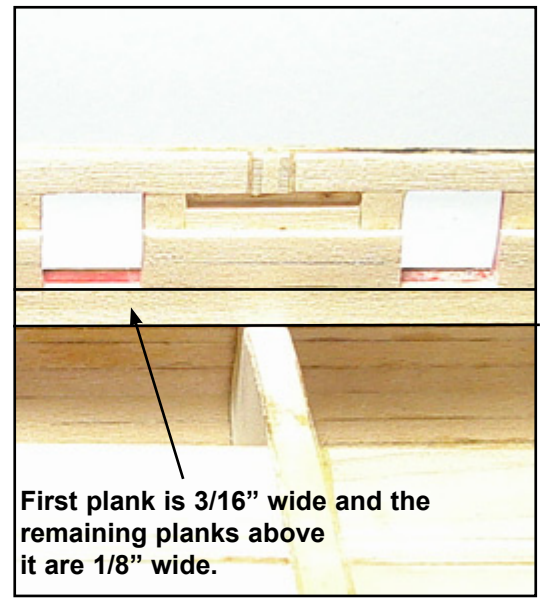
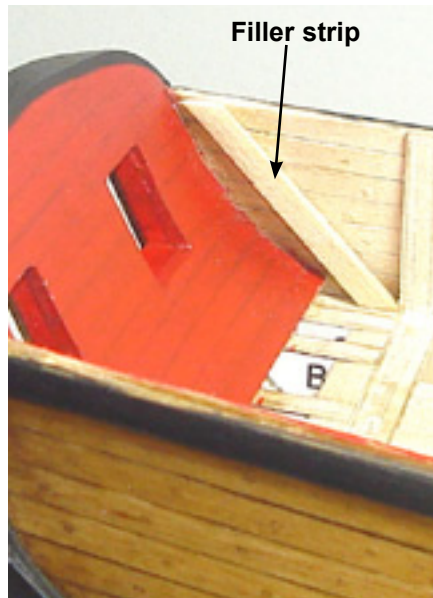
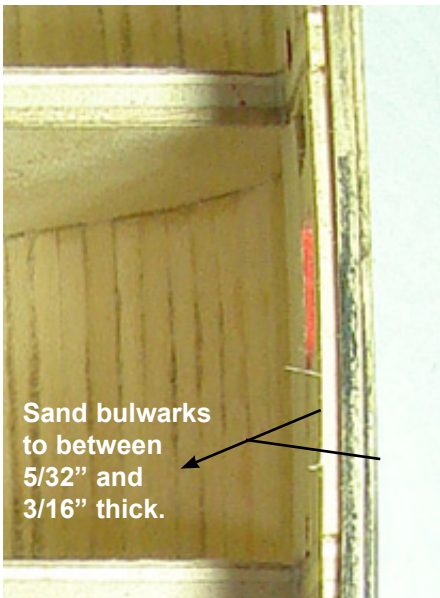

## Chapter Seven **Planking Inboard (deck and bulwarks)**

With the planking completed on the outside of the hull you can now turn your attention to planking inboard. Before you start planking however, the bulwarks must be thinned down to their proper thickness inboard. The bulwarks should be thinned down to  $5/32$ " thick. If you feel up to the challenge it can even be thinned down more. The bulkheads were originally created thicker than needed for added strength. If they were cut to the proper thickness originally they would have been too fragile and probably would have snapped while framing the ports and planking the exterior of the hull.

After planking the bulwarks with  $1/16$ " x  $1/8$ " strips a cap rail will be placed on top of the bulwarks. This cap rail will be  $1/4$ " wide and it won't fit properly if the bulwarks aren't thinned down to the width required. So take your time here and measure that thickness in various locations down the length of the bulwarks until you are satisfied. If you prefer, the bulwarks can gradually taper from the deck upward to its proper thickness. It does not have to be  $5/32$ " thick from top to bottom. However, there will need to be some thinning at the deck level. But if you find it difficult, it can be left a little thicker there. See the photo above.

Once the bulwarks are sanded you will need to add a filler strip along the bulwarks at the stern. This will give you

a surface to glue the bulwark planking to. Any size strip will do. It will end up being about  $1/16$ " thick. It should be sanded down to match the thickness of your bulwarks. See the photo above.

Use a  $3/16$ " x  $1/16$ " thick strip as your first bulwark plank. This plank should fit nicely since you should have  $3/16$ " of space from the top of the bulkheads to the top of the gun port sills. If you don't have  $3/16$ " of space between the top of the bulkheads and the port sill then the top of the bulkheads should be sanded down until you do. Be careful to maintain the proper camber of the deck while doing so. Using the wider first plank will make it easier to finish the bulwark planking. All of the bulwark planking should be cut flush to the edge of each gun port. With the first plank in position you can switch to  $1/8$ " x  $1/16$ " planks to finish the bulwark planking. When the planking is completed, sand it smooth and paint the interior red. You can also sand the top of the bulwarks down to accept the cap rail which will be created next. The finished cap rail will end up being  $1/4$ " wide when completed. It consists of two elements to achieve the  $1/4$ " width. A  $3/16$ " wide cap rail is positioned first and then a  $1/16$ " wide molding strip will be added to the outside edge bringing it to  $1/4$ ". It will overhang the bulwarks inboard and outboard. The cap rail and bulwarks may get a little wider at the bow but this is ok. See the photos provided.



**The bulwarks have been planked and painted. The cap rail has been glued in position.**

**More Photos of the finished cap rail and bulwark planking.**

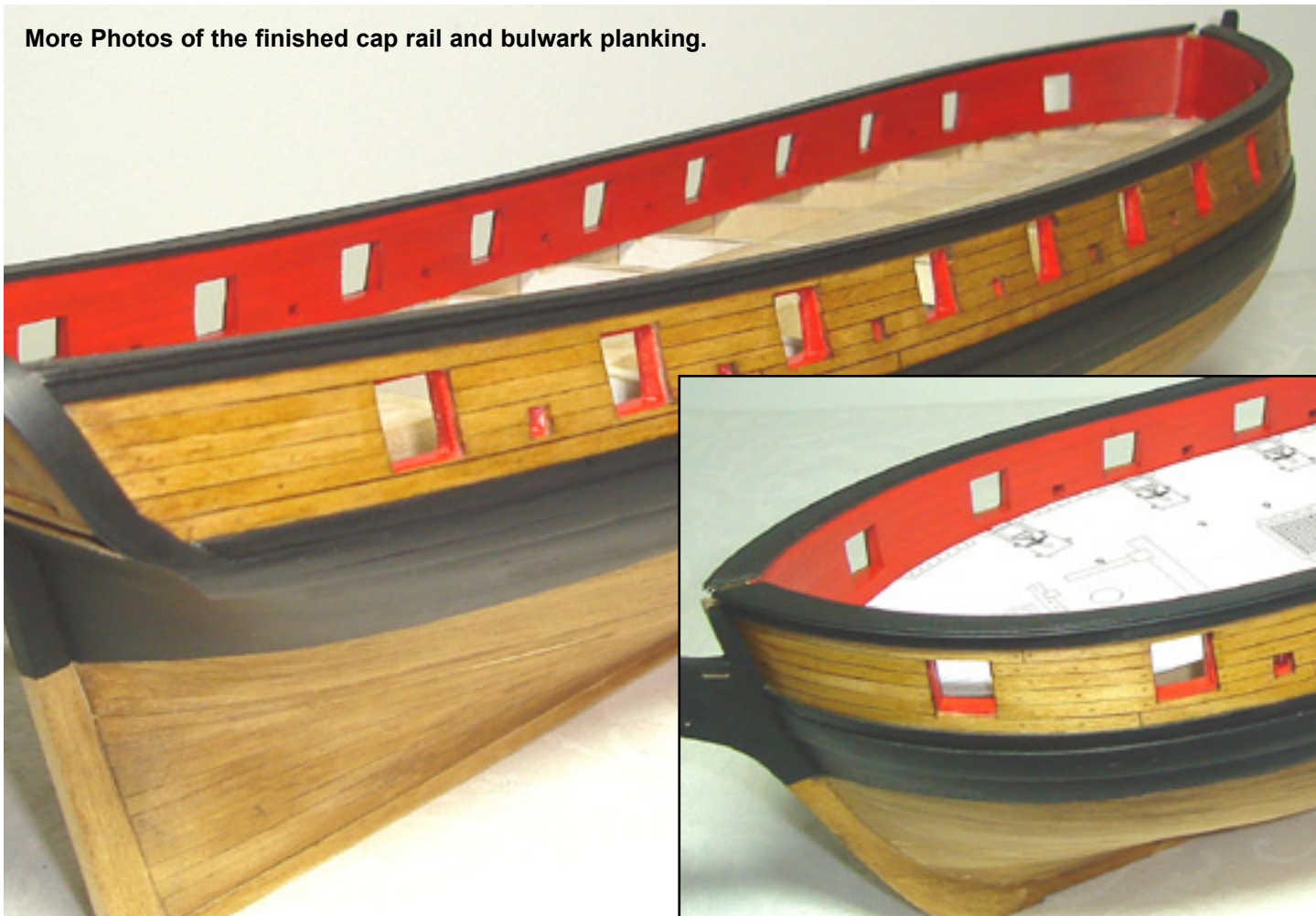

The cap rail at the bow will be cut from a 1/16" thick sheet. It will be 3/16" wide. The cap rail at the bow curves significantly and bending a 3/16" strip edgewise would be difficult. To establish the proper curve, press the basswood sheet firmly on top of the bulwarks at the bow. Simply trace the outboard profile of the bow onto the sheet. Then create another line inside of this one in order to establish the proper width of the cap rail. Always make the cap rail a little wider so it can be sanded to its true width after it is glued into position. Only the curved section at the bow needs to be created this way. The remaining section of the cap rail can be added using a 3/16" x 1/16" strip.

Sand the first piece of the cap rail flush with the external planking but leave a little overhang inboard. Fill any seams between the curved cap rail and wood strip and sand it smooth. At this point the cap rail should be approximately 3/16" wide except for along the extreme bow where it may be wider. To finish the cap rail glue a 1/16" x 1/16" strip along the outboard edge of the cap rail. This molding will give you the overhang outboard that the plans call for. Sand the top of the cap rail smooth and paint it black. Several photos are provided that show the bulwarks planked and the cap rail painted and completed. Note how a gap was left at the bow to accommodate the bowsprit. More advanced modelers may want to create a fancy molding edge on the outboard edge of the cap rail. As shown on the plans the molding strip would have had a double beaded profile.

**Companionway framing is completed.**

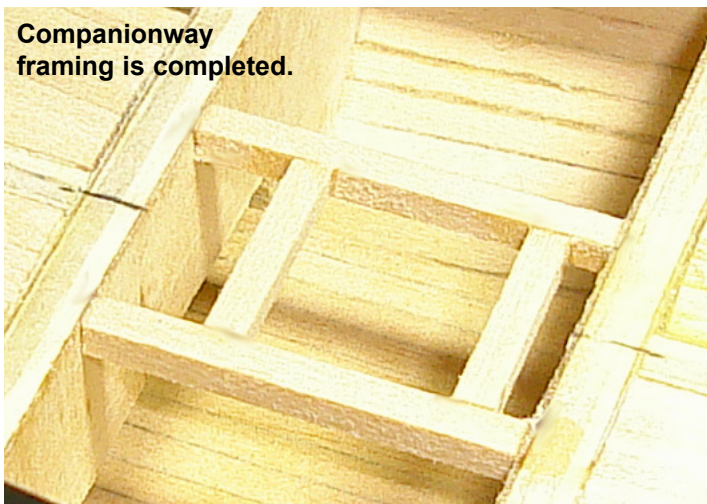

The deck will be planked with 1/8" x 1/16" basswood strips. As usual, before you can start planking a few things should be taken care of first. The companionway will need to be framed with 1/8" x 1/8" strips. See the photo provided. You can use the framing plan as a guide for all of the measurements. Be careful to ensure that the opening for the companionway is centered properly in relation to the centerline.

The deck planking will be nibbed or "joggled" into a margin plank that runs along the bulwarks. This margin plank is





**Margin plank on the port side.**

3/16" wide. The curved section of the margin plank at the bow has been laser cut for you. The remainder of the margin plank is created using a 3/16" wide basswood strip. See the photo that shows the margin plank at the bow along the port side of the bulwarks. Each Syren model will most likely vary a little bit, so test fit them in position before you glue the laser cut pieces on permanently. The ends of each piece have a scarf joint where they will meet the 3/16" strip that continues the margin plank along the hull towards the stern. Cut the end of the strip to fit snugly into the joint before gluing any of the pieces into position.

Take a look at plan sheet one which shows how the deck planking should be nibbed into the margin plank at the bow. The first five or six planks from the center line do not have to be nibbed into the margin plank. Simply cut them flush to the margin plank. The remainder of the planks along the side of the hull should be nibbed into the margin plank. See the photos provided which will show you how to do this. Depending on your experience you may opt not to nib the planks at all. Even though this is a more accurate representation of the deck planking you can also cut them flush to the margin plank if you find the process difficult. It will not hurt the overall appearance of your model. In actual practice the deck planking would have been nibbed into the margin plank along the entire length of the bulwarks. Wherever the end of a plank would meet the margin plank it would be nibbed. This was done when the end of the plank would come to a sharp point. This would

render the plank very weak and prone to quicker rot. Nibbing allowed the end of the plank to remain blunt and square and thus stronger and less likely to rot so quickly. Another method commonly used towards the stern was to taper each plank so they were not as wide from mid ship to the stern. The planks would actually follow the bulwarks so no plank ends would come into contact with the margin plank.

This method would require some advanced modeling skills and each deck plank would need to be spiled to its proper shape. In the end most of the deck planking along the bulwarks will be covered with the carronade sleds, rope coils and other deck fittings. It is up to you to decide which method best suits your skills and preferences.

While planking the deck be sure to stagger the plank butts from bulkhead-to-bulkhead. Each segment of deck planking should only be long enough to span across four bulkhead edges. A "four butt shift" for the plank butts was used on the prototype. This refers to the fact that as you lay your planking down, the butt ends will create a pattern where they will repeat every fourth row. You will end up with the butt edge of a plank every three rows which creates the pattern shown in the photos. Caulking between the planks was simulated again by running a pencil down one edge of each plank. Some additional photos are provided that show the deck planking completed with joggling along the margin plank. The deck planking was tree nailed the same way the external planking was. It was sanded and stained with MinWax Golden Oak stain.

The last step in this chapter will be to create and install the waterway around the bulwarks. A 1/16" x 1/16" strip was shaped as shown in the drawing and glued into position on deck along the sides of the bulwarks. There is no waterway along the inboard side of the stern. It was sanded to a triangular profile rather than a square. At this stage there should be 1/8" between the top of the deck and the top of the port sills. Adding the waterway will still

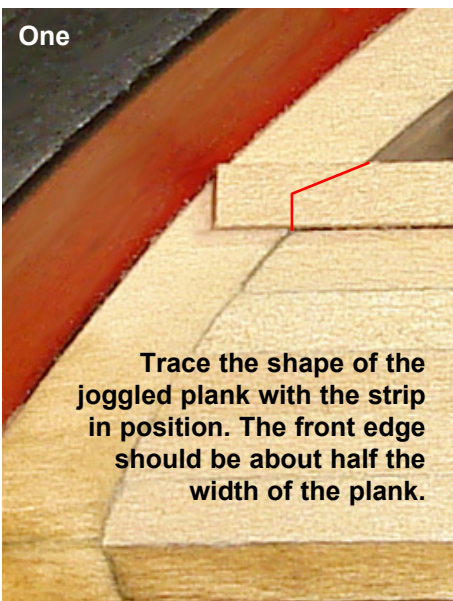

**One**  
Trace the shape of the joggled plank with the strip in position. The front edge should be about half the width of the plank.

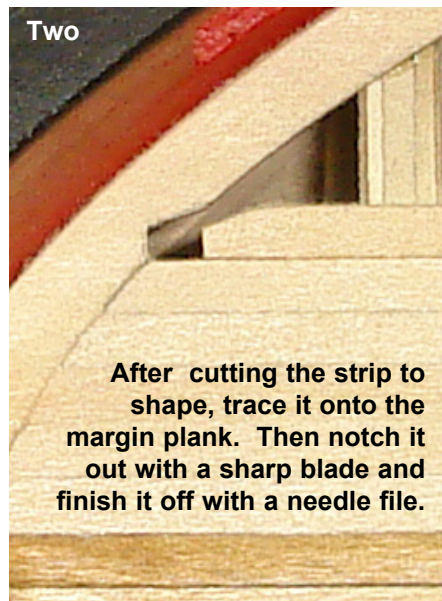

**Two**  
After cutting the strip to shape, trace it onto the margin plank. Then notch it out with a sharp blade and finish it off with a needle file.

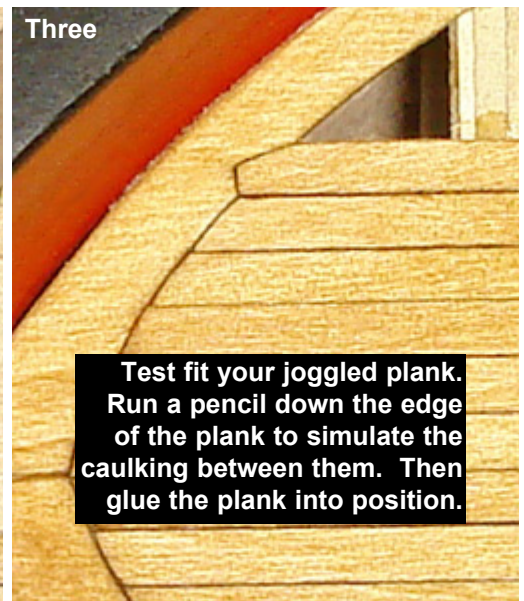

**Three**  
Test fit your joggled plank. Run a pencil down the edge of the plank to simulate the caulking between them. Then glue the plank into position.



Plank joggling or "Nibbing"



leave 1/16" between the top of each sill and the top of the waterway. This is very important because this space is needed for the carronade sled supports that will be added later. If you don't have 1/18" of space between the top of the port sills and the deck you should use a strip of wood that is slightly smaller for your waterway. The waterway can be stained to match the deck when finished or painted red to match the bulwarks. The choice is yours. It was done either way in general practice at the time. The waterway was stained on the prototype. A final photo shows the work completed with the waterway in position.

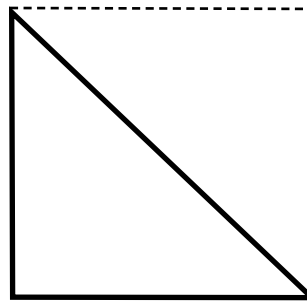

The Waterway is shaped from a 1/16" x 1/16" strip and sanded to the triangular profile shown.

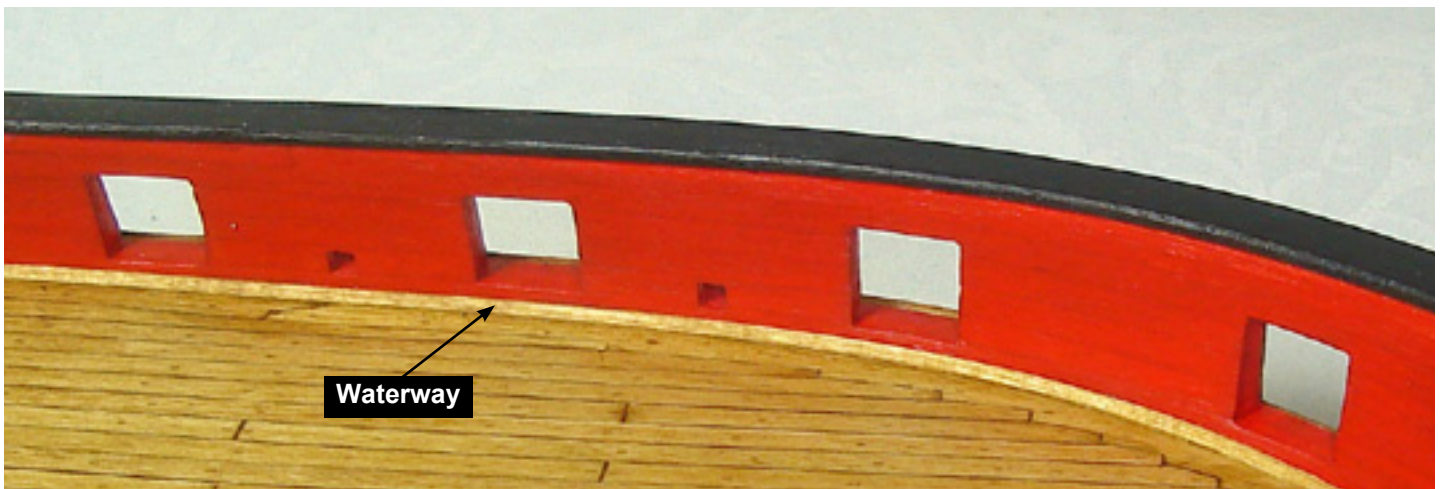





## Chapter Eight Copper Plates/Rudder

Covering the hull below the waterline with copper plates will add a great deal of detail and interest to your model. Depending on your skill level it can be done in various ways. On the real ship the copper plates would have been nailed to the hull. Some model builders like to simulate these nail heads using either a ponce wheel or a stamping jig. However due to the small scale of our model you might opt to omit such small details and it would be just fine. A stamping jig was created and used to simulate the nail pattern on the prototype. Instructions for creating such a jig are supplied for you just in case you want to give it a try. The individual plates ( $1/4" \times 11/16"$ ) can be cut from a roll of copper tape which has adhesive applied to one side. A sharp pair of scissors will do the trick. The adhesive makes the plating process go much quicker since there won't be any glue needed to apply them. Before doing so make sure the hull is free from any dust. Wipe it down with a damp cloth.

The plates will be applied in rows. The first row will be applied at the keel working your way from the stern towards the bow. Each plate should overlap the preceding plate by about  $1/64"$ . The remaining rows will also overlap the preceding row by about  $1/64"$ . Start applying the plates by covering the outside edge of the stem and stern post first. See the illustration provided. Then begin applying the plates in rows as mentioned. Do not place any copper plates along the bottom of the keel. The false keel ( $3/16" \times$

$1/16"$  wood strip) needs to be glued there and it is best to glue it onto the bare wood rather than a layer of plates.

If you examine the standing rigging plan you will notice a plate pattern is shown. Note how the rows of plates work their way upward towards the waterline. A single row of plates (a dressing belt) will finally run along the waterline to neatly finish it off. The dressing belt will overlap the main area of the plates below it. It is easier to draw a reference line approximately  $3/16"$  below your waterline before you begin. This will allow you to cut the plates cleanly in preparation for the final dressing belt. Be careful not to touch the plates too much as you progress. The oils from your fingers have a tendency to leave fingerprints which are difficult to remove afterwards as the copper begins to develop a patina.

Some model builders prefer to artificially tone the plates rather than leave them bright and shiny. The decision is purely a matter of personal tastes. Many products are available commercially that will tone the plates and every model builder has their own preference. Some simple home-brewed applications exist also. They can be researched on the internet. Lemon or other citrus juices are one possibility. Once both sides of the hull are completed you can glue the false keel into position. Be careful

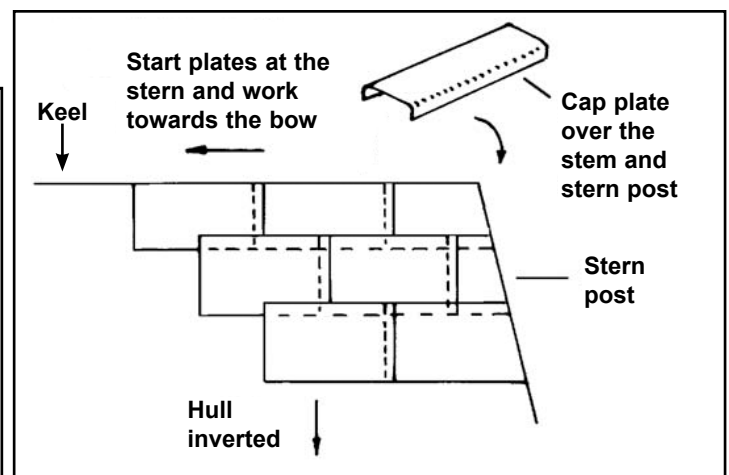
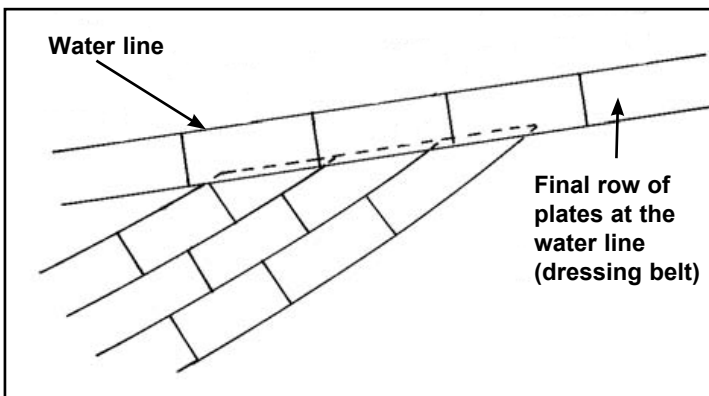

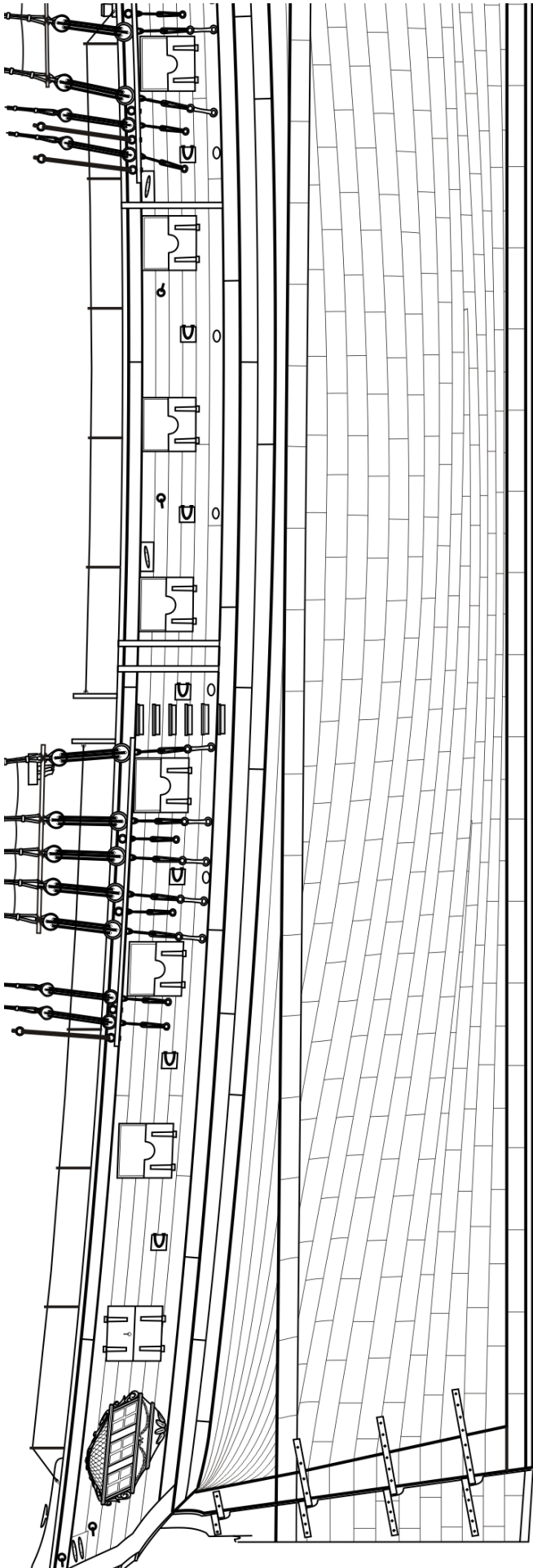

For placement of copper plates

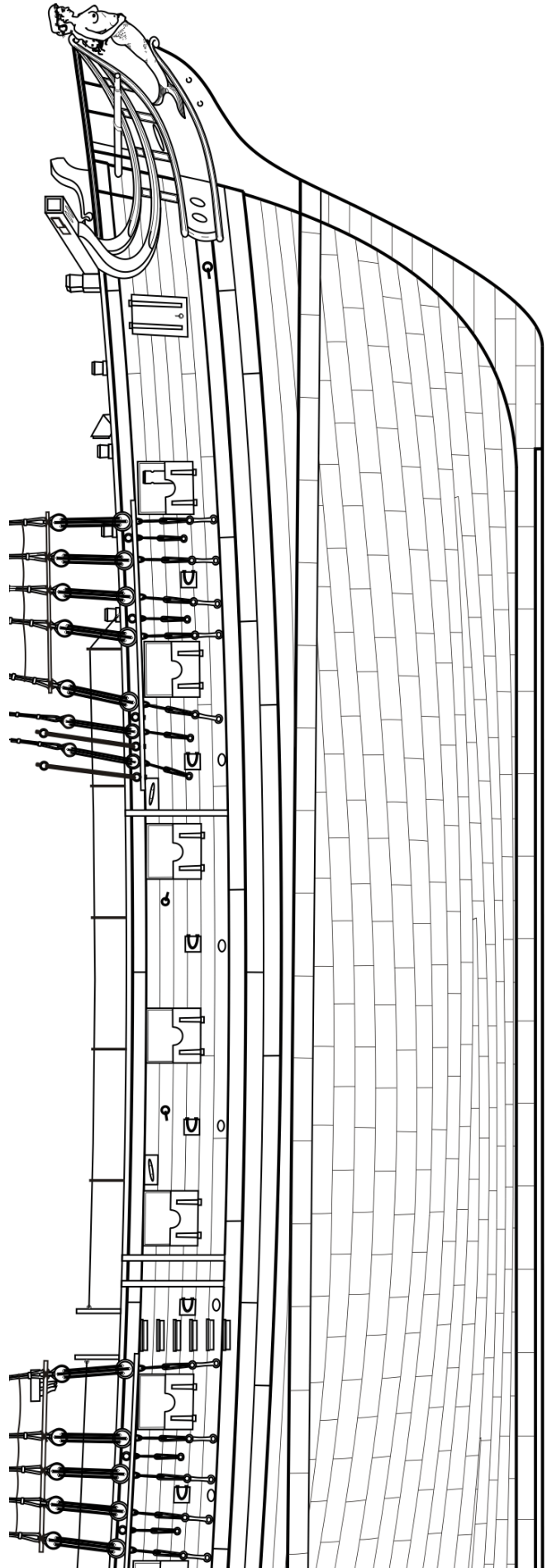



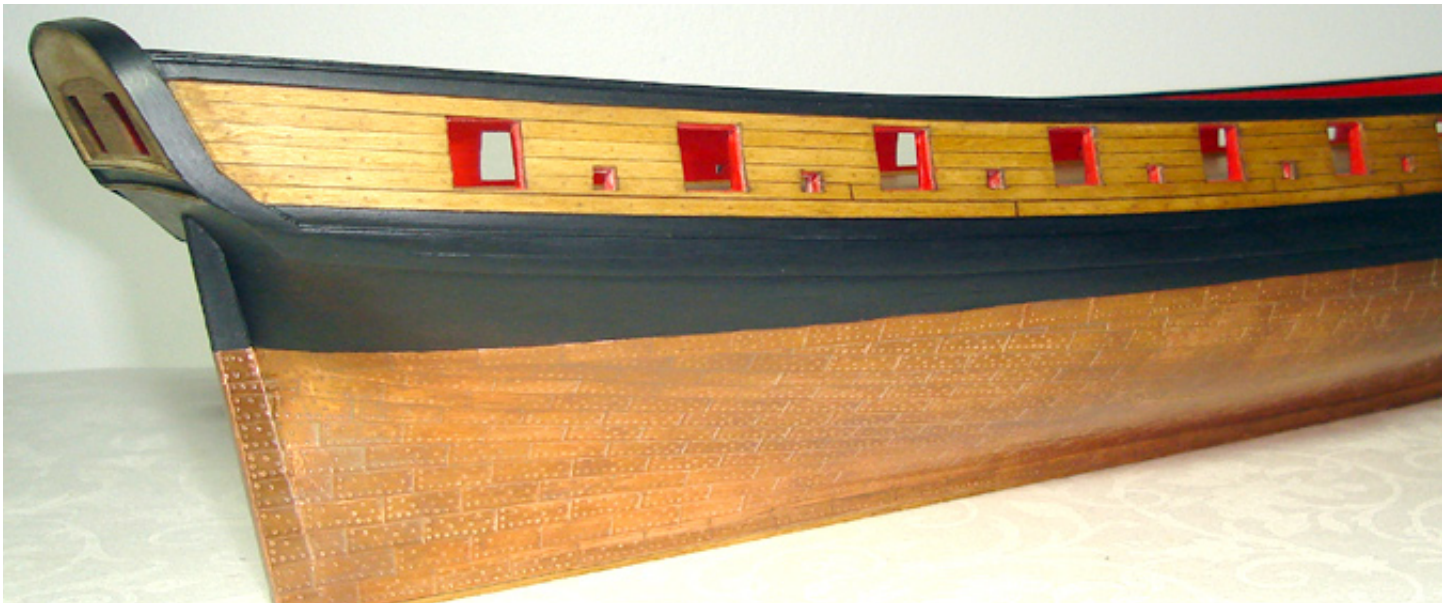

not to get any glue on the plates as it will most certainly show after the plates begin to develop a patina.

The rudder will be plated below the water line also so it would be a good time to create and install it now. It has been laser cut for you. See the illustration provided which shows the general profile that needs to be established. The rudder actually tapers to about 1/8" wide towards its aft-most edge. The forward side of the rudder is beveled on both sides which allows it to easily swing from side-to-side. Hold the rudder against the stern post and mark the waterline on both sides. Keep in mind that the false keel actually extends to the rudder also. A small length of strip wood will eventually be applied along the bottom of the rudder so position it against the stern post with this in mind.

Cover the rudder below the waterline with copper plates. Again it would be easier to start by covering the outside edges first. You can also extend the dressing belt across

the waterline on the rudder since it will create a consistent look across your finished model.

The rudder should be painted black above the water line but only outboard. The inboard portion of the rudder head can be left natural or painted red to match your bulwarks. Two eye bolts should be glued into pre-drilled holes on either side of the rudder as shown in the illustration previously mentioned. The rudder pendants will be secured to these eye bolts later. A small piece of copper tape can be cut and used to simulate the iron strap that the eye bolts are secured through. The rudder pendants would have prevented the rudder from being lost at sea if it slipped out of the gudgeons. The rudder pendants were long chains that had heavy ropes spliced onto their other ends. The ropes were carried over the transom and were belayed to cleats along the bulwarks. These will be added later. Don't forget

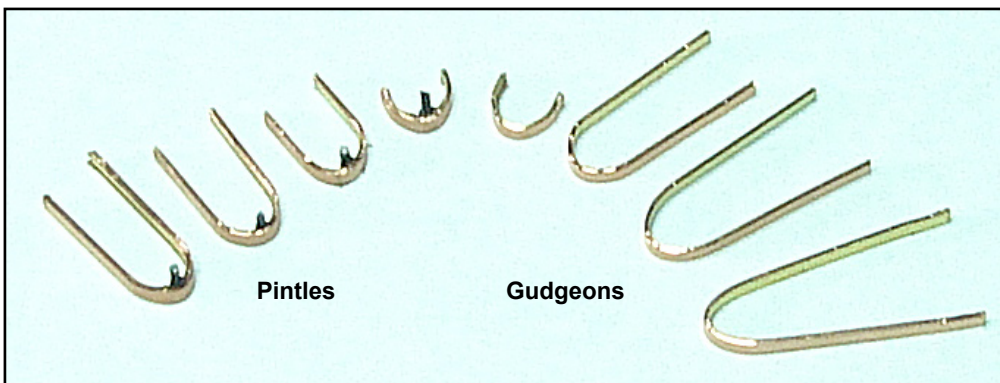
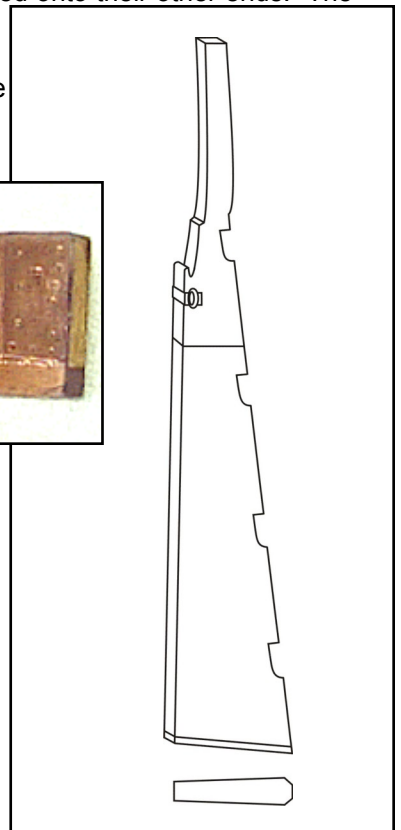
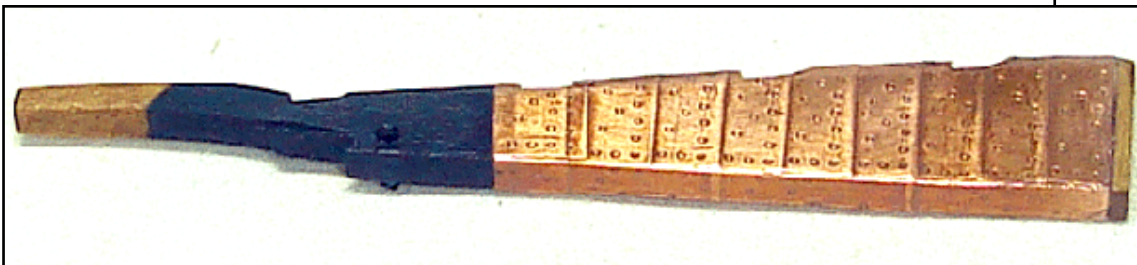

Pintles

Gudgeons



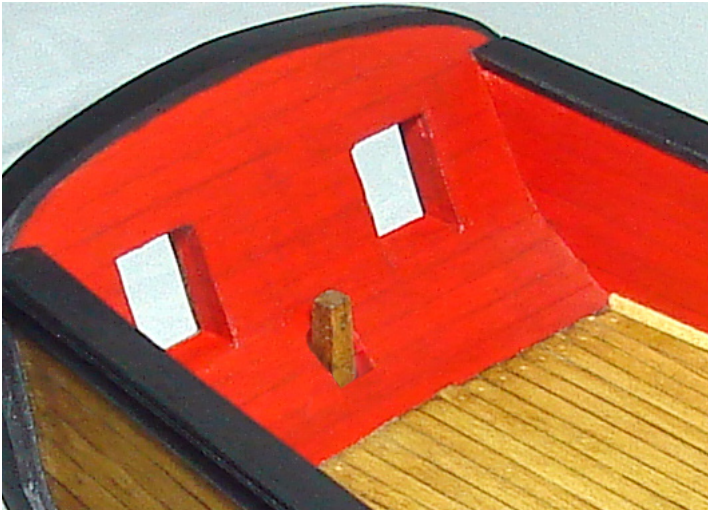

to glue a length of 3/16" x 1/16" wood strip along the bottom of the rudder which would have protected it much like the false keel.

The opening for the rudder needs to be drilled through the lower counter. It needs to be large enough that the rudder can swing freely (side-to-side) after it is mounted. Drill the hole from the outboard side first. Only pierce the outside layer of planking on the counter initially. The hole should be positioned against the stern post. Use a small drill bit to start the hole and slowly enlarge it to the final shape with a round file. If you look at the photos provided you can see that the hole on the inboard side sits high on the counter. It essentially follows the angle created by the stern post. Drill through the initial hole up through the inboard layer of planking at the correct angle. This is a tricky operation which is why a smaller drill bit should be used initially. Slowly enlarge both holes until you can successfully fit the rudder head through it. As you enlarge the opening more and more it will become clear what adjustments need to be made. Eventually the rudder should lay flat against the stern post and have enough room to swing freely. Proceed slowly as you continue to refine the shape of the opening making very small and deliberate adjustments. When you are satisfied you can move ahead and create the gudgeons and pintles.

The rudder is secured to the stern post with hinges called gudgeons and pintles. The gudgeon is the portion of the hinge attached to the hull. The pintles are attached to the rudder. They will be made from brass strips that are 1/16" wide. On the real ship the pintles and gudgeons were not made of iron. They would have corroded quickly due to the fact that the iron would have a corrosive reaction when coming into contact with the copper used to plate the hull. The pintles and gudgeons were actually made from the same material used to produce the hull plating. Before shaping them, you can cover the brass strips with some copper tape. They will tone up nicely and match the plating on the hull. Burnish the tape well after you cover the brass strips. Cut the brass strips to length and bend them as shown in the photo provided. You can actually bend them around the rudder to get an exact fit. A scrap piece of 3/16' thick basswood can be used to bend



the gudgeons to shape. The pintles and gudgeons are essentially the same except that the pintles will have pin attached to them. The pins were cut to length using 22 gauge wire. They can be soldered to the pintles for the strongest joint possible however CA (super glue) will work as well. Be careful to center each pin on the inside of each pintle. Test their length in the notches of the rudder to make sure they are not too long before you secure them to the pintles permanently. Glue the pintles on the rudder first. The pintle above the waterline can be painted black. Check the plans for the proper angle. They should run perpendicular to the stern post.

Then slide the gudgeons behind the pintle pins so the entire rudder assemble can be test fit on the hull. They should fit snug behind the pins. If they are too loose then carefully bend the pins inward until they will stay in position. If you were to glue the gudgeons directly onto the hull it would be nearly impossible to attach the rudder through them afterwards. The gudgeons need to be positioned on the rudder and glued onto the hull as one assembly. This procedure is more easily accomplished if you work with the hull upside down. Don't use too much glue to attach the gudgeons to the hull. It will be difficult to remove the glue from the cooper plates without damaging them. Make sure you wipe off any excess that squeezes out from under the gudgeons quickly before it dries. The bolt heads can be simulated on the pintles and gudgeons using a wooden dowel that has been sharpened to a blunt point. You can emboss little divots into the copper tape spacing them evenly along each strip. Examine the photos provided.



Cast Britannia metal carvings were painted to look like wood

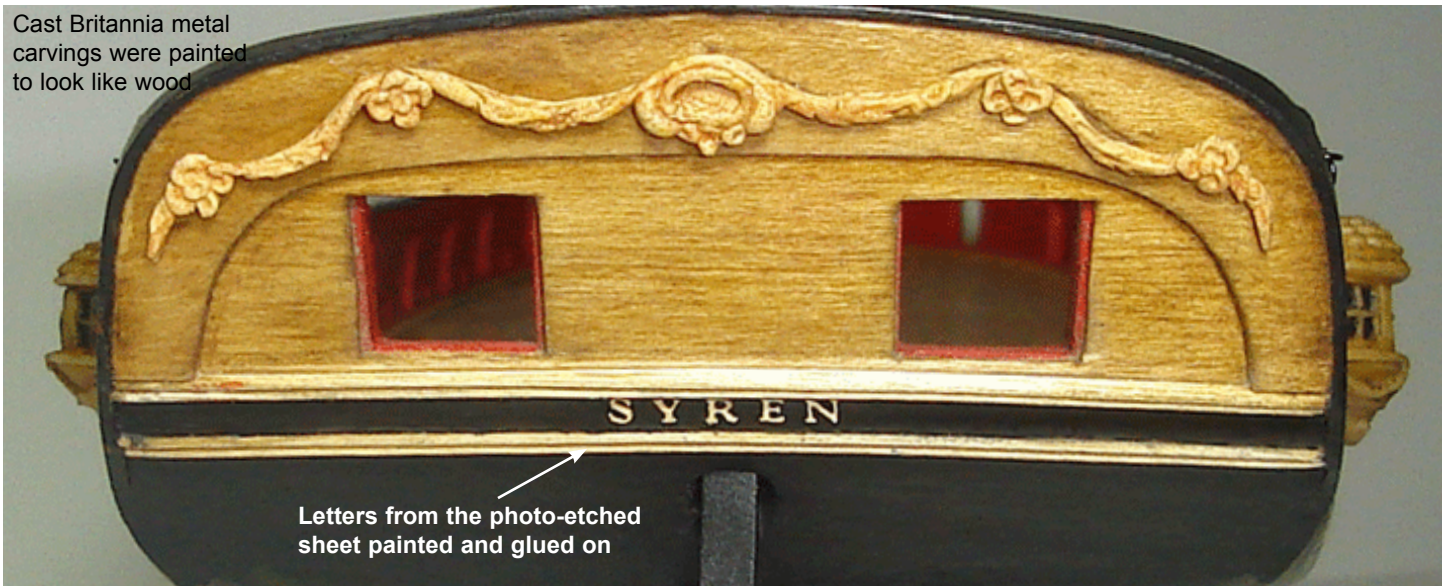

Letters from the photo-etched sheet painted and glued on

## Chapter Nine Hull Details

In this chapter you will start adding the details to your hull. Starting at the stern you can use the letters for the ship's name provided on the photo-etched sheet. These letters are quite small and you will soon see why more than one set of letters were provided. It would probably be best to paint them before you glue them into position. The letters on the prototype were painted to look like wood.

The cast decorative carving above the stern ports is supplied in three pieces. Use the plans as a guide to position them. They can be painted and finished to look like wood as was done on the prototype. This should be done before you glue them to the stern. You might opt to use various colors depending on what your preferences are. No records have been found that show or describe what the Syren's stern decorations actually looked like. The drawings shown on the plans were reconstructed using typical design elements used during that time period. Once completed you can turn your attention to the sides of the hull. The port lids at the stern will be added later.

The quarter badges can be added next. The actual design for these was taken from the original draft. These quarter badges actually served no purpose. They were purely decorative. Some historians believe they may have been used on ships like the Syren to make them look more formidable from a distance at sea. It is a real possibility that the windows on these badges were not even made of glass. They could have been simple wood panels painted black to simulate the window panes. Once again you can finish your quarter badges as presented on the prototype or you could paint them with various colors depending on your personal preference. Before gluing them onto the model the sheaves and eye bolts shown on the plans should be made first. It will be easier to do so without having the badges in the way. (see the photo below) They are positioned just behind the badges. The badges are designed to fill the space between the sheer strake and the wales. They are exactly 3/4" high. If they are a tight

fit you can sand the bottom edge of the sheer strake or the top edge of the wales to make more room for it. Just remember to sand the entire length of the ship to keep the strakes consistent along the hull.

The two sheaves are simulated. They will be used for the main course braces and sheets. These details must be added to the port and starboard sides of the model. Try and keep both sides as identical to each other as possible. To create the sheaves, two small holes were drilled to simulate them. They don't have to be drilled all the way through the bulwarks. The rigging line will just be pushed into the aft-most hole of each sheave part way. A corresponding sheave simulation on the inboard side of the bulwarks will be used the same way and once completed, the rigging line will have the illusion that it actually runs all the way through to the inside of the hull. To finish off each sheave a narrow groove is made between these two holes as shown in that same photo. A pin vise can be used to first indent the wood between them. Then run it back and forth in the groove to deepen or widen it as needed. Once satisfied a sharp pencil is run along the groove to darken it. Two split rings were created from 28 gauge black wire and hung from smaller eyebolts glued into the hull. The braces and sheets for the main course will have their standing ends belayed to these rings.





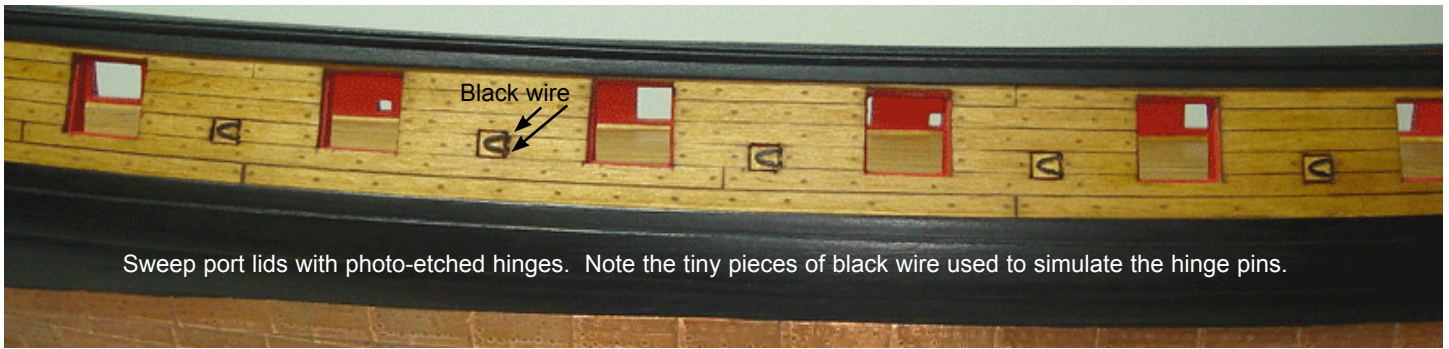

Sweep port lids with photo-etched hinges. Note the tiny pieces of black wire used to simulate the hinge pins.

The sweep port lids are made from a 1/16" x 1/8" basswood strip. The lids for the sweeps were cut to length and test fit in each port opening. These lids were opened and closed with horseshoe shaped hinges. These hinges are supplied on the photo-etched sheet. It is easier to paint the hinges black before you remove them from the photo-etched sheet. They can also be chemically blackened. Glue the port lid onto the hull first. Leave a little bit of space all around the perimeter of the port lid. Don't make the lids so tight that the outline of the ports is not easily seen. Then glue the hinge on top of it. The hinge should be positioned as shown above and the two ends finished off with a tiny length of 28 gauge black wire. This wire will simulate the hinge pin. It adds that extra bit of detail that will make the lids look more realistic.

When the sweep ports are finished you can start on the remaining gun port lids. There are ten gunports on each side of the hull. The aft most port will not have a cannon or carronade so the lid was modelled closed on the prototype. You could build it as an open port if you prefer. This port had a split lid with hinges for the top and bottom halves. Each half was made by gluing two 1/8" x 1/16" basswood strips together edge-to-edge. The inboard side and the edges were painted red. Two eye bolts were glued into the inboard side of each lid to simulate the handles on them. After gluing them, the eye bolts were bent downward. Both halves of the lid were then glued into position on the model. The photo-etched hinge straps were painted black and glued onto the outboard side of each lid afterwards. Small lengths of 28 gauge black wire were glued to the ends of each hinge strap to simulate the hinge pin. Finally a small eyebolt was added for the top half of the split lids only. It is fitted

between the two hinge straps. A rope will be attached to this eye bolt later and carried over the bulwarks and belayed to a cleat along the inside of the bulwarks. See the photo below left. Also note the inboard sheaves and port lid on the opposite side of the hull for reference.

The bridle port is the forward-most gun port on the hull. There won't be any guns mounted through these either. So they were also shown as closed ports. The bridle port has a one piece port lid. It was made the same way but this time four pieces of a basswood strip were glued together edge-to-edge. It also has eye bolts inboard for handles (only two on the bottom of the lid) and longer photo-etched hinge straps. It is made exactly like the split lids. See the photo below right. Notice in both photos how the planking strips for the port lids line up with those used for the hull planking.

The eight remaining ports on each side have split lids also. However these were a little different than those described earlier. These lids had a circular opening cut into them. This circular opening allowed the carronades to be stowed with the barrel protruding through the opening on the lids. Half of the circular opening was cut out of the bottom lid which was hinged to the hull. The upper half was called a buckler and was not hinged onto the hull permanently. It was held in position by being forced into a rabbet cut into the top, inside edge of the port opening. The lower edge of the buckler also had a rabbet which married up with the rabbet cut into the lower half. It was literally "buckled" into position which is how it got its name. The eye bolts (handles) on the inboard side

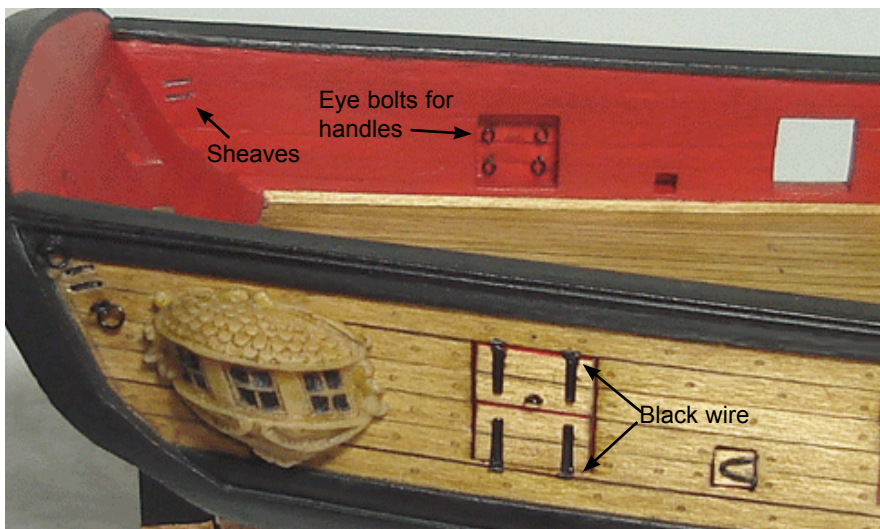



## Files for shaping port lids

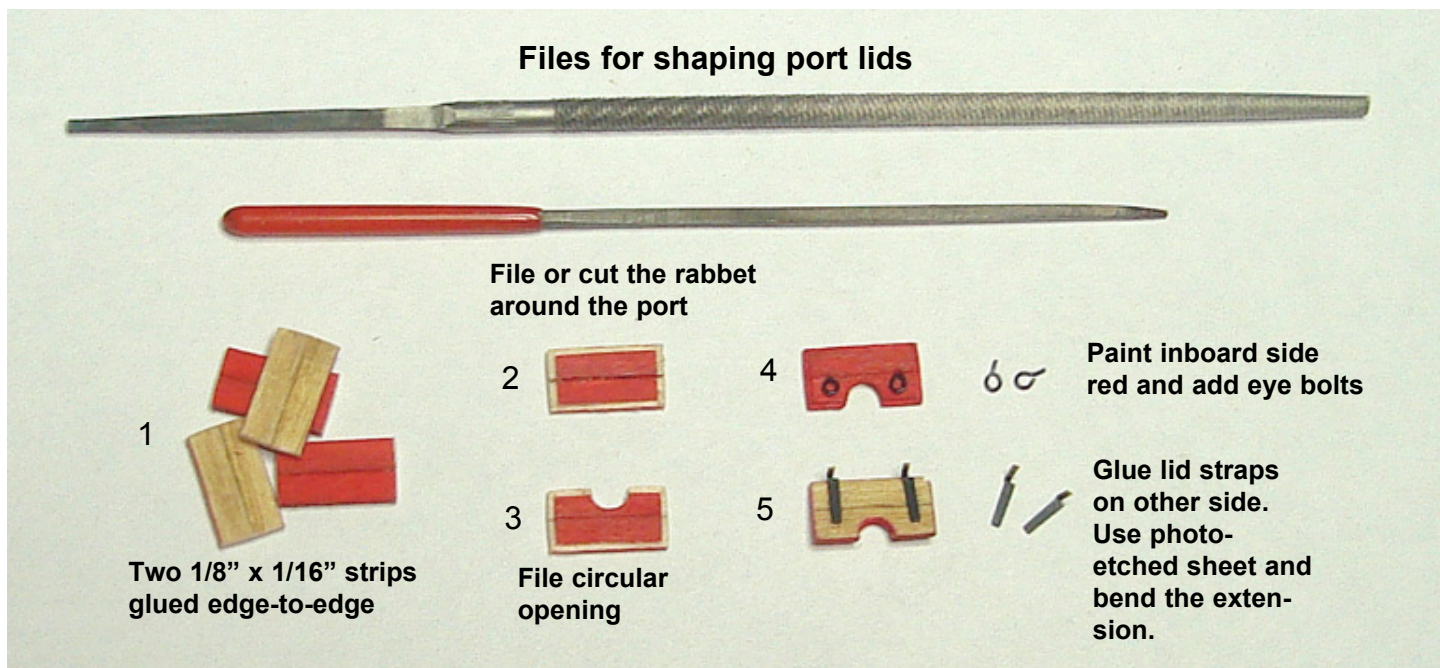

(top and bottom halves) were lashed together holding them tightly closed. The buckler when not in use was stowed away. It was only used during the roughest weather. They will not be shown on the model. The lower halves are shown open since the carronades will be mounted later in the project.

The photo above shows you how to construct the bottom half of these port lids. Note how the photo-etched hinge straps were used to secure them to the hull once they were completed. When removing the hinge straps from the photo-etched sheet you should leave the extension intact. The extension is the small brass piece that holds the hinge strap to the photo-etched sheet. You won't need to use the full length of the extension. Only half of it is needed. These extensions are bent back and inserted into tiny holes drilled into the hull just below the port openings. See the photo below left. Other than this detail and the circular opening, these lids are constructed just like the others. To finish them off after they are mounted onto the hull, a tiny length of 28 gauge black wire was glued above each hinge strap to simulate the hinge pin. It was glued just above the hinge strap as they enter the hull. The pins should look like they are part of a single hinge strap assembly. The only port lids left to build are the stern port lids. They

are also split port lids. They are going to be shown open. These are made just like the lower lids described above. The only difference is they don't have a circular opening cut for the long guns. Both the upper and lower halves are hinged permanently to the stern. See the photo on the next page. Notice how the eye bolts used to simulate the handles on the upper halves look like they are hanging downward. These shouldn't be bent against the lid like the lower halves. The upper half also has an eye bolt on the outboard side so a rope can be seized to it. This rope will be taken over the transom and belayed to a cleat above each port inboard. This will be done later after we start adding details on deck.

There are five scuppers on each side of the hull. The scuppers were small drainage pipes that allowed water to drain off of the deck. The openings for these pipes can be simulated on our little model. The scuppers are located just below each sweep port at mid ship. Use a small drill bit to create the holes. Don't drill straight through the bulwarks. Make each hole only about 1/16" deep. These pipes were probably made of (or lined with) lead. You can use a pencil to darken the inside of each scupper. Make a corresponding scupper hole inboard as well. These will be drilled through the waterway. The scuppers were sloped

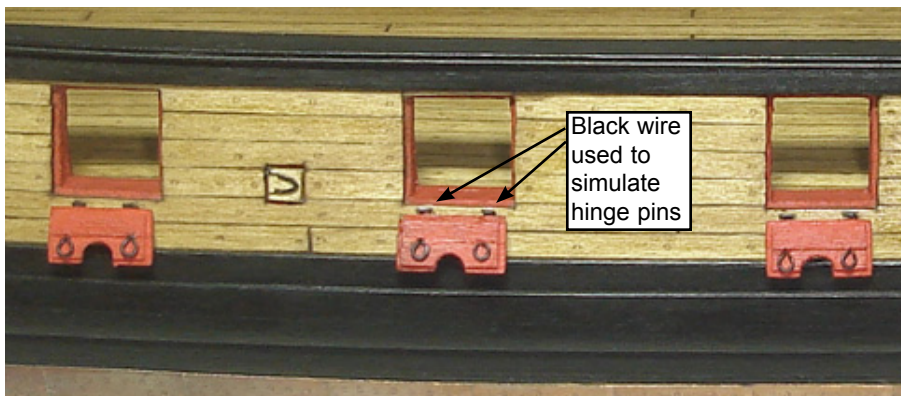
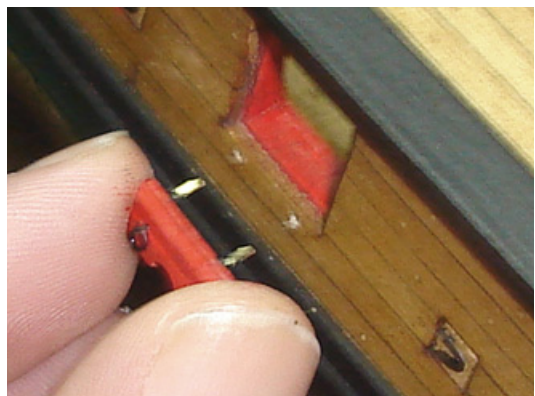



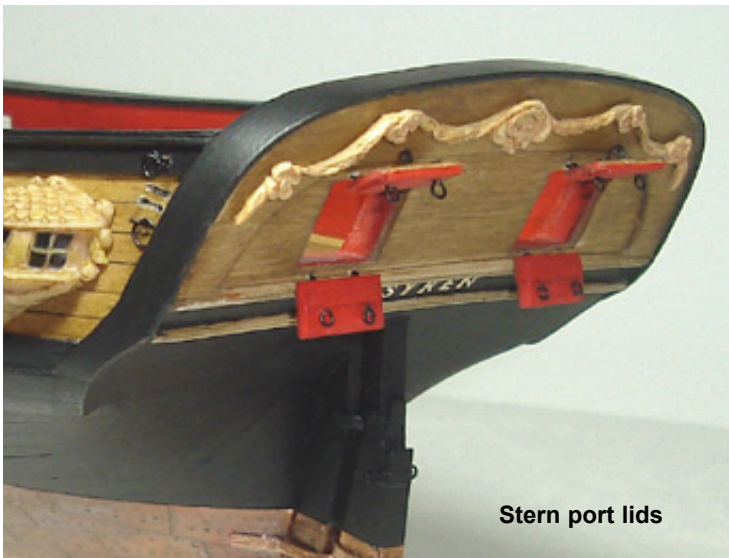

The “tack” for the main courses will run through this fairlead and through a sheave simulated in the hull. See the rigging plan for details. The fairlead is just a small hole drilled through the top of the chesstree.

When the fenders and chesstrees are completed you can create the simulated sheaves through the hull like those you made earlier at the stern. Check the plans for their locations and angles. These will be used for the main course tacks and the fore course sheets. Remember to also make a corresponding sheave for each of them inboard along the bulwarks. There are two sheaves on each side of the hull. Two eye bolts with split rings are shown on the plans as well. The standing end for those sheets and tacks will be seized to these before working their way through the sheaves.

downward so the scuppers on the outside of the hull will actually be lower than those made through the waterway.

The boarding ladders on the outside of the hull are made using a basswood strip 1/16” x 3/32”. See the photo below. You can see two of the six steps that haven’t been shaped yet. You can use a sharp #11 blade in your hobby knife to carve them to shape. Various needle files could also be used. Glue them to the hull using the plans as a guide to establish their position and spacing. The bottom-most step should be sanded so it isn’t as deep as the others. This step will be glued to the upper wale. The wales already “stand proud” of the hull planking and the last step can be sanded so it isn’t as deep as the other five. This last step can also be painted black.

There are two fenders just forward of the ladders. These were laser cut for you. They are 1/16” thick. The bottom of each fender rests on the upper wale. The top of the fender should be notched out so it fits over the sheer strake. The portion of the fender that shows above the sheer strake should be painted black. Another similar fitting called the “chesstree” can be seen just forward of the fourth gun port. It is actually the same shape as the fender but has a fairlead drilled through it. Larger ships would have used sheaves.

The last detail you can add to each side of the hull are the channels. These were laser cut for you. They are cut from a 1/16” thick basswood sheet. The small slots along the outside edge of the channels can be sanded with a needle file. They mark the locations for the dead-eyes/chain plates and a few eyebolts which will be added later. A molding strip will be glued across the front edge of the channel to hold them in position. Hold the channel against the hull so you can check their locations. Your gun port spacing may vary slightly from the plans and the slots may need to be adjusted.

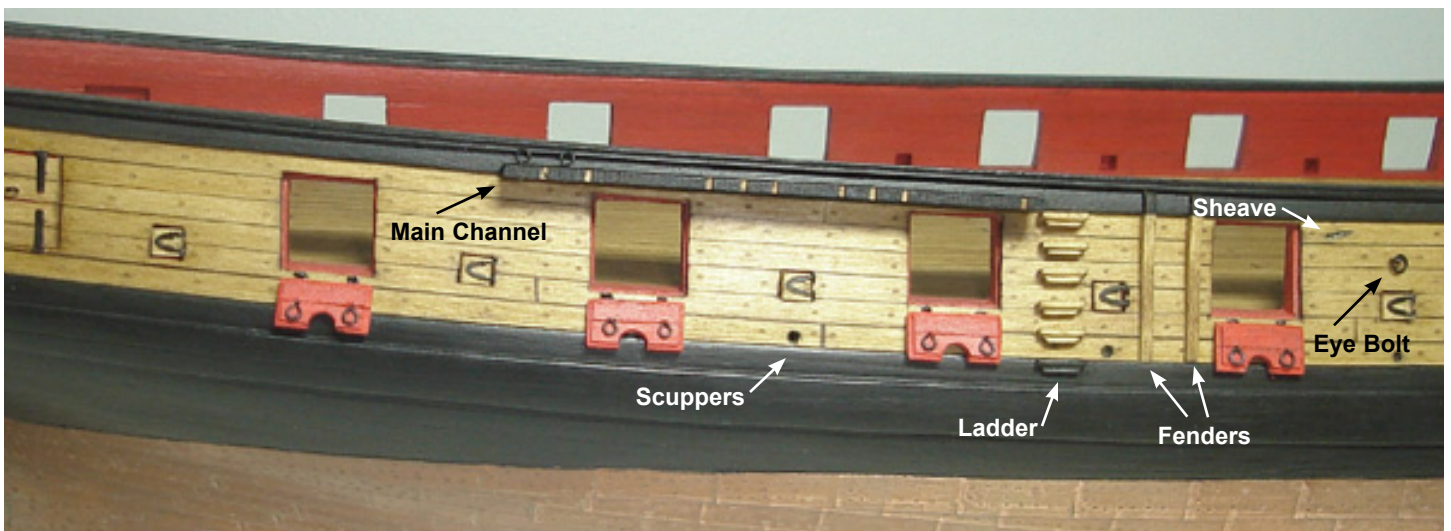
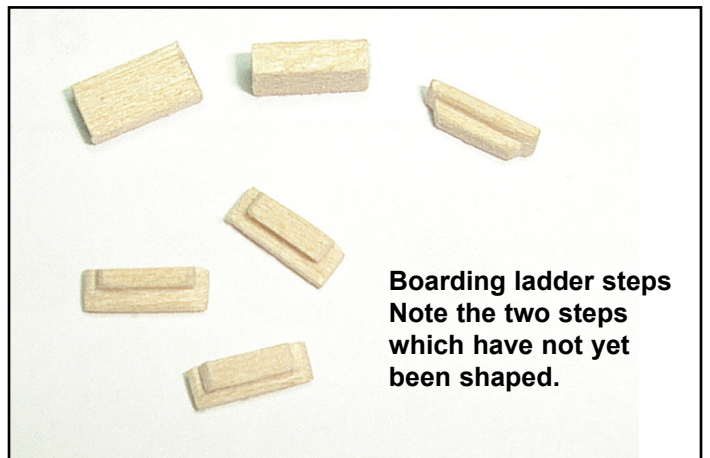



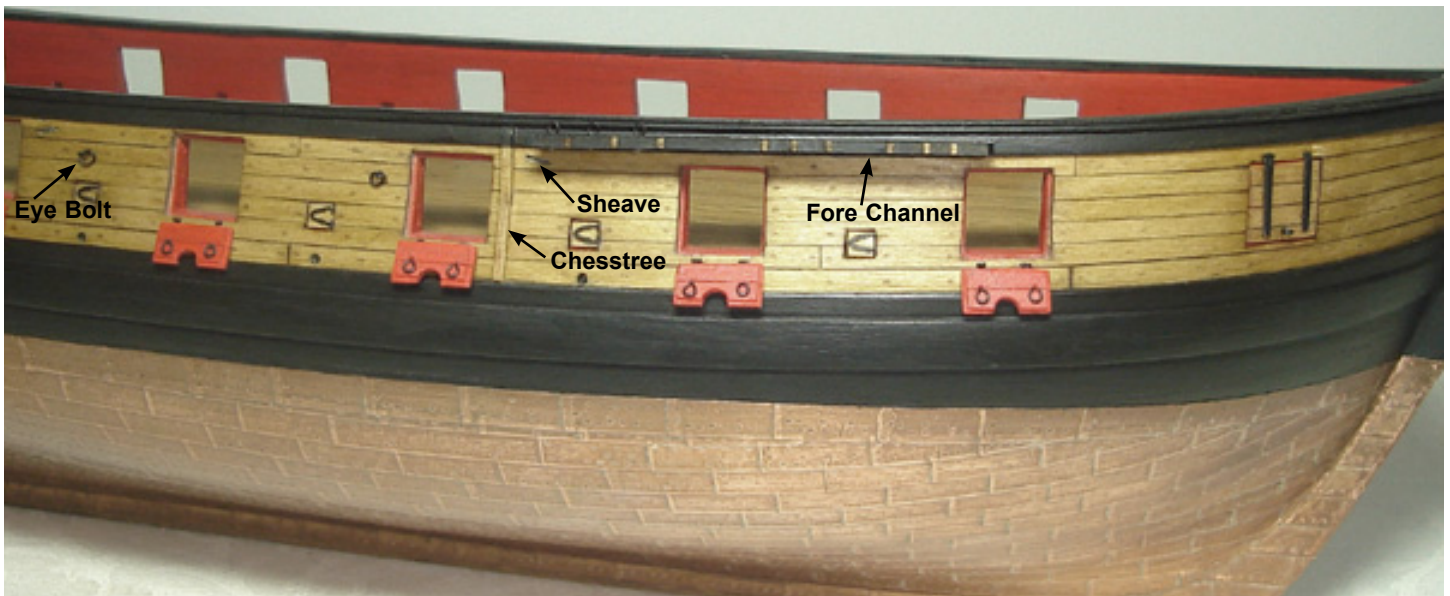

Several smaller eye bolts however, should be added to the channels now before you glue them into position. There are three on the fore channels and two on the main channels. These eye bolts are positioned behind the dead eyes and their locations are shown on the plans. They are made from 28 gauge black wire. See plan sheet one for details. The channels are painted black. They are glued to the sheer strake and you can use plan sheet one to find their exact locations. For added strength you might consider "pegging" them to the hull. Insert a small length of 22 gauge wire into the edge of the channel and leave about 1/16" sticking out from the edge. Drill corresponding holes into the sheer strake (after determining their proper locations) and glue the channels into position. These pins will give the channels some added strength. It will keep them from pulling away from the hull while tensioning the lower shrouds and chain plates. Note: It is very important

that the channels are located properly along the side of the hull. Examine the plans very carefully before gluing them into position. It is also extremely important to line up both fore channels and main channels so both sides of the hull are symmetrical.

---

**A Model Expo exclusive!**  
**Log on and join Chuck Passaro's**  
**Syren forum. Get help and building**  
**tips from fellow Syren builders and the**  
**designer himself!**

For more information go to:

[www.ModelExpo-online.com/Syren](http://www.ModelExpo-online.com/Syren)

Inboard look at the scuppers and sheaves

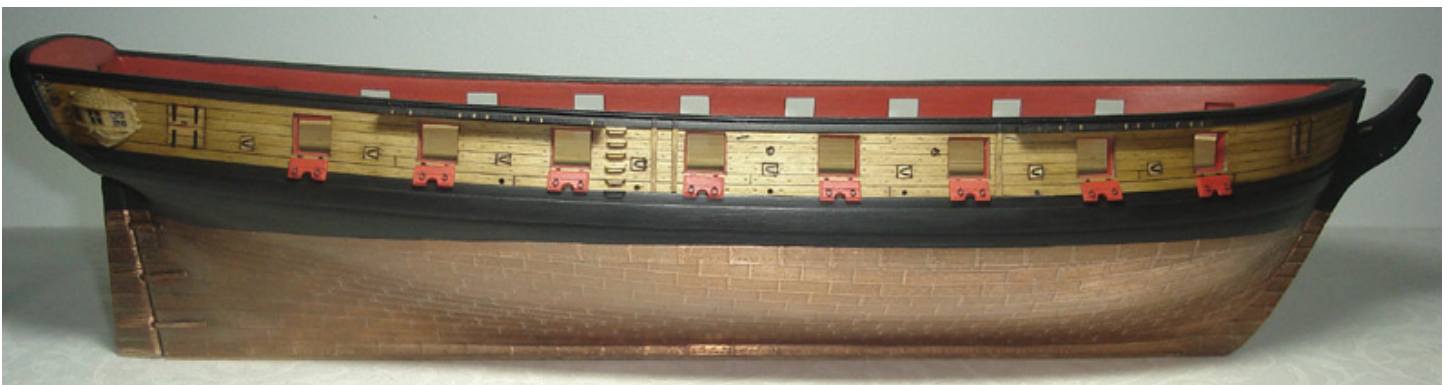

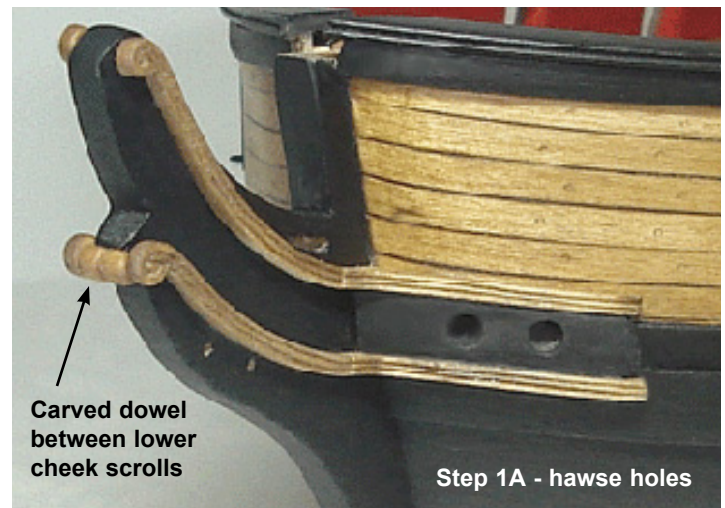
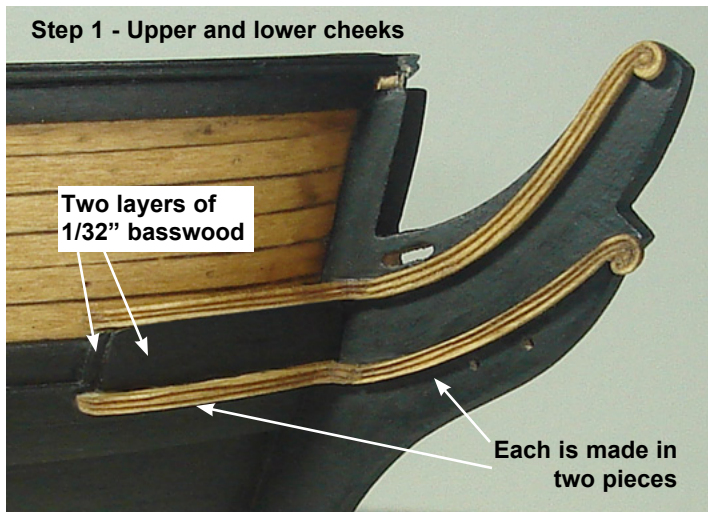

## Chapter Ten Head Rails and Figurehead

Constructing the head rails for any period ship model can be a challenge. There are some very complex curves and angles for each piece. It goes without saying though that these features give any model its character and are very important. The delicate and graceful nature of the head rails can make your model look very elegant. However if done poorly and out of scale it would make an otherwise well done model look very crude. For this reason the process of constructing the head rails has been broken down into smaller tasks. Each task should be considered a small project itself and produced with care. Templates for each portion of the head rails are provided for you on the plans. Most of the elements have been laser cut for you. They are still need to be custom fit for your model however. Step one will begin with the construction of the cheeks.

**Step One** — There are a pair of cheeks on each side of the head. These cheeks support the head timbers and the head itself. Each cheek is made up of two sections. First is the portion of the cheeks that are placed on the bow of the model. The hawse pipes are positioned between them. Then they continue onto the stem where the second sections are added. The tail of the mermaid (Syren) figurehead will fit between these. Their forward ends are finished off with a small scroll or volute.

These sections have been laser cut for you from a 1/16" sheet of basswood. Sand them to shape and test them on the model for a proper fit. The lower cheek piece can be

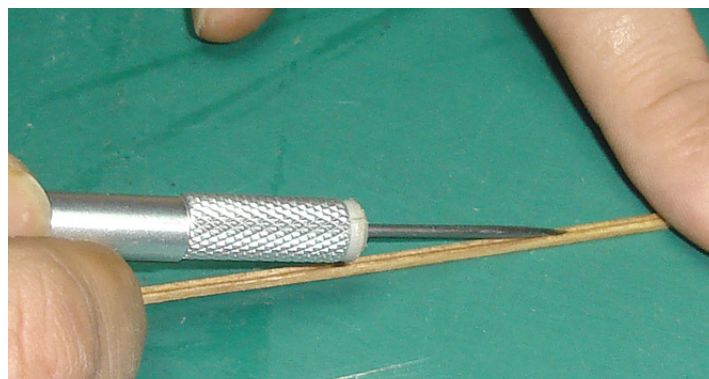

made a little narrower as they will fit over the wales which stand proud of the external planking. When you are happy with the shape and fit for these pieces you can glue them onto your model. Note their locations on the plans.

Depending on your skill level you may want to carve the outside edges for these elements. The head rails were often carved with a fancy molding profile. These details can be scraped into the cheeks or carved by hand. One method would be to use a sharp #11 blade to lightly score each cheek. Only use the lightest pressure and make a cut for each groove you intend to create. This cut mark will serve as a guide only. You will only have to score a shallow cut. Then use an awl as shown in the photo below to lightly indent the cut mark along your scored line. Start with a light pass at first and start applying more pressure with each succeeding stroke. The awl should be held at an angle so the wood fibers won't tear. It is more akin to shaping than carving. You won't be removing any wood. You will be denting the cheeks with each pass of the awl. This creates the groove of your molding profile. You will soon see how that first cut with your hobby knife only acts as a guide for your awl to follow. It prevents the tip from wandering off and ruining your piece.

Once glued to the bow the cheeks segments that extend along the stem (sometimes called hair brackets) can be made using the same techniques. They are also laser cut from a 1/16" thick sheet of basswood. Be sure to stain all of these pieces ahead of time before you glue them onto your model. Some glue will affect the way the finish reacts on the wood. It's better to stain them first. The laser cut pieces provided for each segment of the head rails were designed to give you a little "wobble" room to sand them to shape afterwards. Every model will be slightly different and require some tweaking to fit properly. The cheeks are no exception. These pieces were left slightly longer so you can adjust them, especially to get a good joint between the two segments. See the photos provided for step one. It shows both cheek pieces glued into position. The decorative molding and scrollwork can be carved using



## Step 2 - Upper head rail

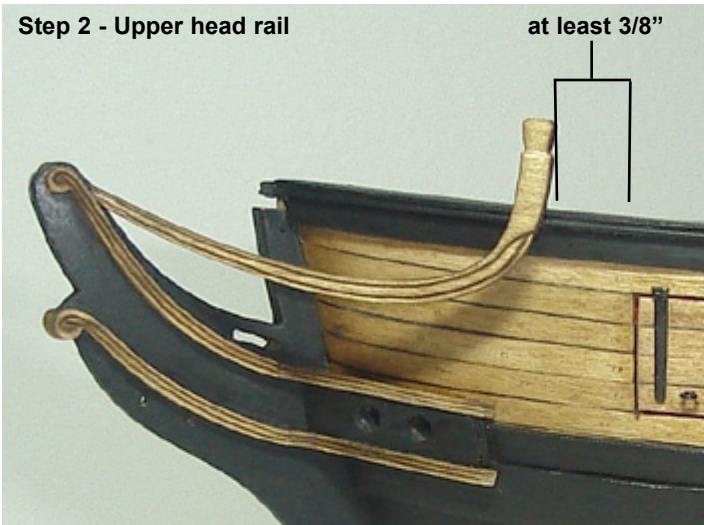

the method described earlier. Note that the lower cheeks will extend slightly past the front edge of the stem. You can see this on the plans and in the photos. The space between them will be filled in later with some decorative carving.

To finish step one, (step 1A ) two layers of 1/32" thick basswood are glued between the two cheeks on the bow in preparation for drilling the hawse holes. The first layer is cut with a scalloped aft edge. This will give you the "fancy" edge that is shown after the second layer is applied. The second layer is made the same way only a little shorter than the first. The first layer is used to level the surface with the thicker wales. It gives you a nice flat surface to glue the second layer onto. The hawse pipes can be drilled through them when you're done. The hawse pipes are drilled parallel to the keel. They are also angled upward as they work their way inboard. See the detailed drawing provided on the plans. The outside holes will be slightly lower than those made inboard. Only drill through the outboard layer of planking first. Then create the inboard hawse holes by drilling through the inboard planking just above the waterway. See the inboard plan for details.

Finally a small decorative piece of wood can be added between the two scrolls of the lower cheeks. You can see

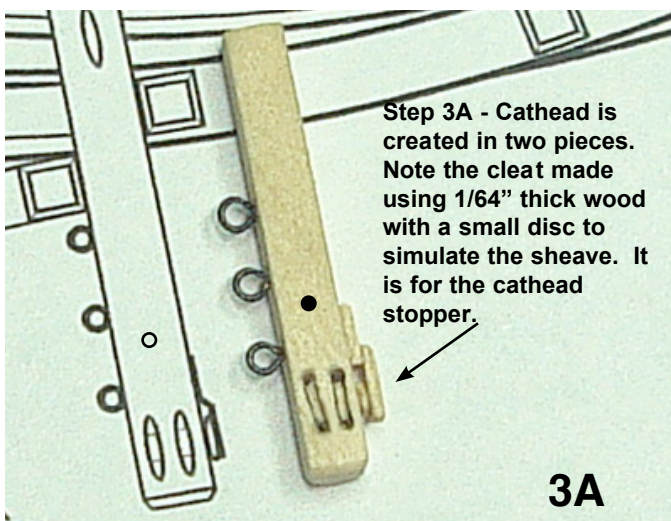

3A

it in the photo 1A. A dowel was sanded or filed to shape. The volutes on the ends of the lower cheeks will extend past the front of the stem and the space between them will be filled in with this carving. Sand and shape it to suit.

**Step Two** — The upper rail is laser cut from a 1/8" thick sheet. It is made in one piece. The upper rail tapers to 1/16" thick as it works its way towards the scrollwork of the cheeks. This is very important to the overall look of the head rails. The other end will stay 1/8" thick and a timber head is carved into it. Use a file to shape the timberhead on all four sides. The carved grooves and molding profile can now be made also. See the photo provided. Test the fit of the upper rail on the model. Once again it has been left a little long. There should be at least 3/8" to 7/16" between the upper rail and the first gun port. This is crucial as there needs to be ample room for the cathead and middle rail you will build in Step three. Before gluing the upper rails on the model make sure you temporarily position them on both sides of the head to check the symmetry from the front of the model. The rails should be at the same height and distances since many of the remaining head elements are positioned based on the upper rail locations.

**Step Three** - The cathead and middle rail. The catheads should be made before you actually start shaping the middle rails. The middle rail will originate directly under the catheads and they must be glued onto the model first. The catheads are also made in two pieces. The first is shown in photo 3A. This portion of the cathead was made using a 1/8" x 1/8" basswood strip. It was cut to length using the plans as a guide. The outboard end was shaped and two sheaves simulated through that end. Three small eye bolts were glued into pre-drilled holes along the forward edge of the cathead. An additional third sheave is shown on the opposite side. This will be used for the cathead stopper cable when you rig the anchors later in the project. This sheave was created using 1 wood strip that was 1/64" x 1/16". two pieces were used as shown in the photo provide. A small disc was shaped from the same material and used to create the sheave itself. Place the sheave on the cathead first followed by the wood strip behind it.

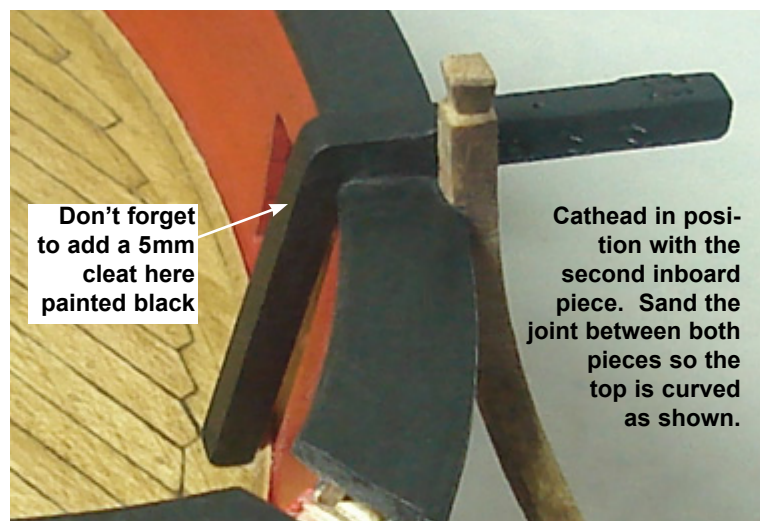



**Step 3B - Middle rail in three pieces**

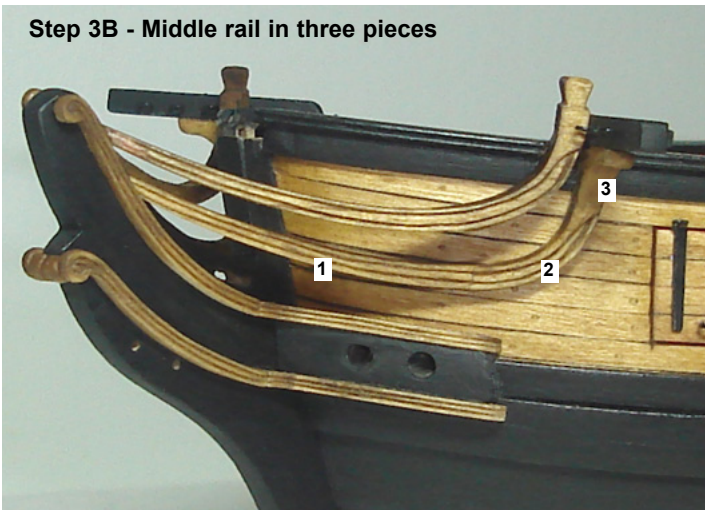

Then place the last strip on top of both of them which does a good job of creating the right look for this fitting. Last, a small hole is drilled through the top of the cathead as shown on the plans. It will be used to secure the cathead stopper. Paint the entire assembly black and glue it on top of the cap rail. But first you should notch the overhang of the cap rail and the sheer strake outboard to make room for the middle rail. It will be placed right below the cathead against the hull. It will be nearly impossible to do so later.

The second part of the cathead is also made from a 1/8" x 1/8" strip of wood. It will be placed inboard and glued along the bulwarks. See the photo provided. The top is rounded off and you can use some wood filler on the seam between both pieces so it is smooth. After sanding it, paint it black. Don't forget to add a cleat to the cathead as shown on the inboard plan.

Now its time to build the middle rail. This is the trickiest rail to build. See photo 3B above. They will be built in the numbered sequence shown in that photo. Sand the 1st laser cut piece from the 1/8" sheet of basswood. Note the top view shown on the plans which you can use as a guide while shaping it.

This segment should taper to 1/16" wide towards the front of the head and gradually increase back towards the bow.

**Step 4 - Head timbers between each rail**

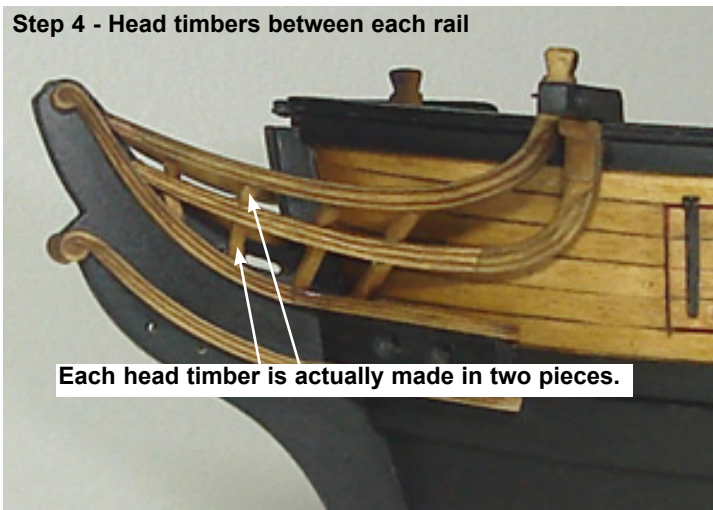

Note how it turns slightly where it will be glued against the bow. There is plenty of thickness in that 1/8" rail to shape it as shown. Test it on the model. The middle rail should be set a little closer to the stem than the upper rail when viewing the head from above. It was left a little longer so you can adjust its length until you are satisfied. Don't place them too close to the stem. Examine the photos below for an idea of where they should be positioned. You can carve the molding profile on the outside edge of this segment before you glue them onto the model.

The second piece of the middle rail is also cut from a 1/8" sheet of basswood. It is also curved when viewed from above. It is very slight but a drawing is provided to give you an idea of how to shape it. Once again it was left a little longer on each end so you can adjust it with some sandpaper. Try and get a good fit at the seam between each of the two segments. Carve the molding profile as shown and glue it into position. Try and line up the decorative grooves between both pieces. The other end should rest against the bottom of the cathead. You may need to angle the top edge of this second segment so it fits snug against the bottom of the cathead. When working on the other side be sure to check the model from the front so you can keep each side symmetrical. The third piece is the hanging knee under the cathead which supports the weight of the heavy anchors. It is laser cut from a 1/8" sheet and it needs to be

**Step 4 - Another view of the head timbers**



**Step 5A - Place four eye bolts on the bow as shown on the standing rigging and belaying plans.**

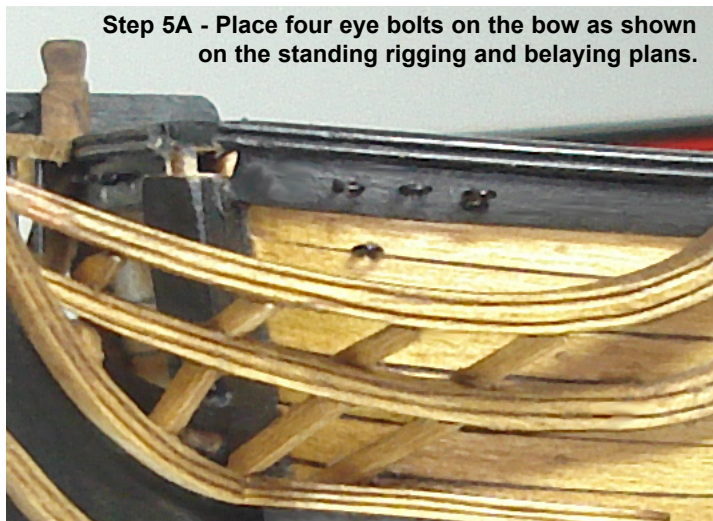



**Step 5B - Create the top rail off of the model and mark the lengths and locations for each stanchion first.**

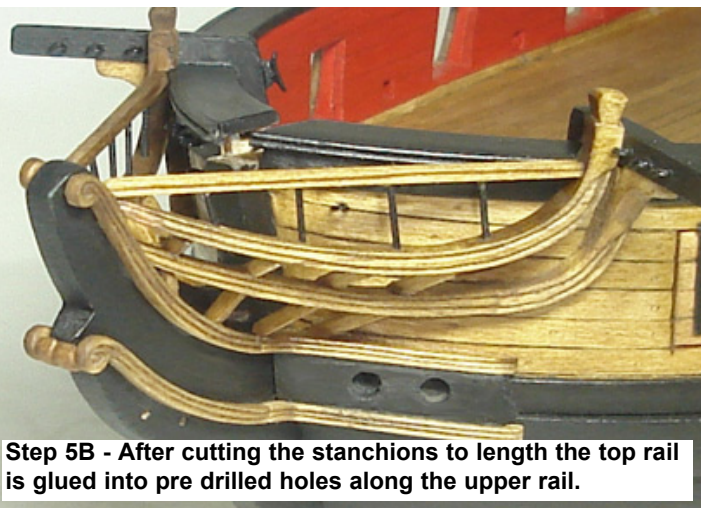

**Step 5B - After cutting the stanchions to length the top rail is glued into pre drilled holes along the upper rail.**

shaped it to suit. There should be a smooth transition from this support knee onto the 2nd piece of the middle rail.

**Step 4 -** You can now cut and position the head timbers between each head rail. These are the vertical timbers that hold the rails together securely. There are four of them. You will create each of them however in two pieces. Each piece is cut from a 1/16" x 1/16" strip of basswood. These are a little tricky at first. The ends of each piece have to be angled so they rest flat against the top and bottom edges of the rails they are placed between. It will take a little practice and you will certainly make and discard several of these before you are satisfied with how they look. Be careful to line up the top and bottom pieces of each head timber so they actually look as though they are one timber. To help you space the four head timbers an equal distance apart it will probably be easier to place the first two on either side of the gammoning slot. Then the two remaining head timbers can be spaced on either side of these an equal distance apart. The head timber closest to the bow is actually placed on top of the upper cheek against the bow.

**Step 5 -** One last rail called the "top rail" needs to be built using a 1/16" x 1/16" strip of basswood. If you examine

the plans you can see it is supported by four stanchions. The stanchions are made from 22 gauge wire. It is easier to cut the top rail to length and test its fit on the model. Note where the top rail originates against the timber head. It is level with the cap rail and its angle is such that it creates a continuation of the sheer of the bulwarks. Test it in position until you are satisfied that it has a smooth run to the stem when you view the model from the side.

Before you finish the top rail you should take the opportunity to place four eye bolts into position on the bow. There are four eye bolts on each side of the stem as shown in photo 5A. It will be very difficult to do so after the top rail is glued onto the model. Examine the belaying and standing rigging plan for details on their exact locations.

Then you can create the molding profile as you did before and drill 4 small holes on the bottom of the rail for the stanchions. You can establish their positions while the top rail is placed temporarily on the model. Glue four extra long pieces of 28 gauge wire into the holes. Then place the rail back on the model so you can mark their lengths. See photo 5B provided. They will eventually be inserted into corresponding holes you will drill along the top of the upper rail. So leave them just a hair longer for now. Bend the





stanchions back a little until you are satisfied with their rake when viewed from many angles. Remove the top rail and cut the stanchions to length.

Then test it once again on the model and mark the locations for the holes you will drill along the upper rail. Drill those holes being careful not to drill all the way through the upper rail. You can now glue the top rail into position. You don't have to glue the stanchions into the holes along the upper rail. If they are pushed into the holes it will be sturdy enough. You only need to glue it at each end. It is easier to push the stanchions into the holes and then pull the whole rail towards you a little out of position. Then place a drop of glue on the timber head and the upper cheek and push the top rail back into position. When working on the other side check the symmetry from many angles before you glue it onto the model.

With the head rails completed you can now add the figurehead. The figurehead was cast in three pieces. Once again you can paint them to look like wood or use the colors of your choice. Paint them all before you glue them into position. Glued the torso on the stem and then add each tail piece afterwards. Then use a little wood filler to conceal the joint between the torso and tail sections. Touch up those areas with some paint to match.

To finish it all up the bumpkins should be created. The bumpkins rest on the top of the headrails as shown in the photo below. A 1/16" diameter dowel was used for both bumpkins. They should be tapered and the end shaped as shown on the plans. The inboard end is simply glued to the hull. You might want to use a length of wire as a peg to make it even more sturdy when installed. Just insert the wire into a pre drilled hole on the end of the bumpkin. Leave a little of the wire exposed to be inserted into a corresponding hole drilled into the hull.

Use a paper strip or sliver of copper tape to simulate the iron bracket holding the bumpkin down on the top of the headrails. Paint it black.



**A Model Expo exclusive! Log on and join Chuck Passaro's Syren forum. Get help and building tips from fellow Syren builders and the designer himself!**

**For more information go to: [www.ModelExpo-online.com/Syren](http://www.ModelExpo-online.com/Syren)**



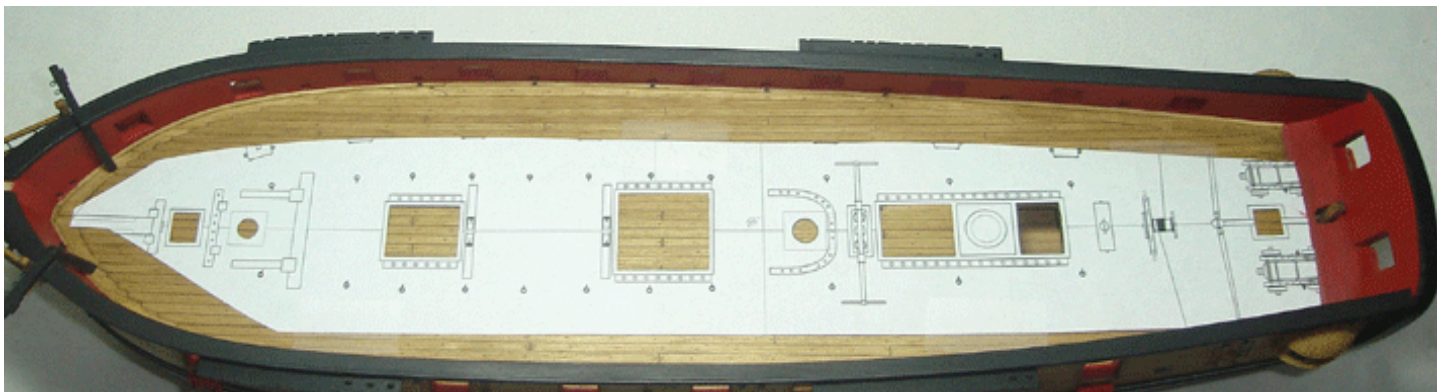

## Chapter Eleven **Inboard Bulwarks and Carronades**

Now that the bulk of the work is completed on the exterior of the hull you can start on the inboard details. But before you start any actual construction this would be the perfect time to draw some reference marks on deck for the positions of the hatches, masts and other fittings. To do so, simply take a photocopy of the deck layout from Plan sheet one and cut out the hatches, mast locations and other shapes. This will create a stencil that will make it easy for you to transfer their locations. Leave the hatch coamings on the stencil only removing the gratings as this will be the way the construction will be described on the prototype. See the photo above for details. Line up the stencil with the opening you created for the companionway in order to establish its proper position. Be careful to also position the stencil along the center line of the deck. Then just trace the openings directly onto the deck with a pencil. It is better to do this now before you start rigging the guns and crowding the deck with other fittings.

With your reference marks completed you can start adding those details to the inboard side of the bulwarks. The swivel brackets for the carronades can be added first. These will be 1/16" thick and are laser cut for you. You can see in the photo provided that each bracket was glued into position so they are level with the gun port sills. This will leave a small amount space under each of them. They do not sit directly on the deck. This feature would have slowed the eventual rotting of these supports because it allowed air to circulate under them. You will also notice in the photo that a small round slot is shown on each bracket. This hole was where the pin of the carronade sled would have been inserted. It would allow the sled to be pivoted in either direction, side-to-side. Since this is a static model we won't

actually be creating the sleds with these pins. They were added to help you center the brackets within each port opening and to also help in establishing the correct placement of the carronade sleds on top of them. You will actually just be gluing the sleds permanently to the top of these brackets.

Fill in any gaps between the brackets and the sill with wood filler and sand them smooth. Paint them red as shown. The aft-most port and bridle ports will not have a swivel bracket as shown on the plans.

The pin rails are also 1/16" thick. They vary in length according to their purpose and placement along the bulwarks. Use the plans as a guide to shape them. You can use a strip of 1/16" x 1/8" basswood for most of them but those along the curved bow will need to be cut from a basswood sheet. The "actual" pin rails would have been

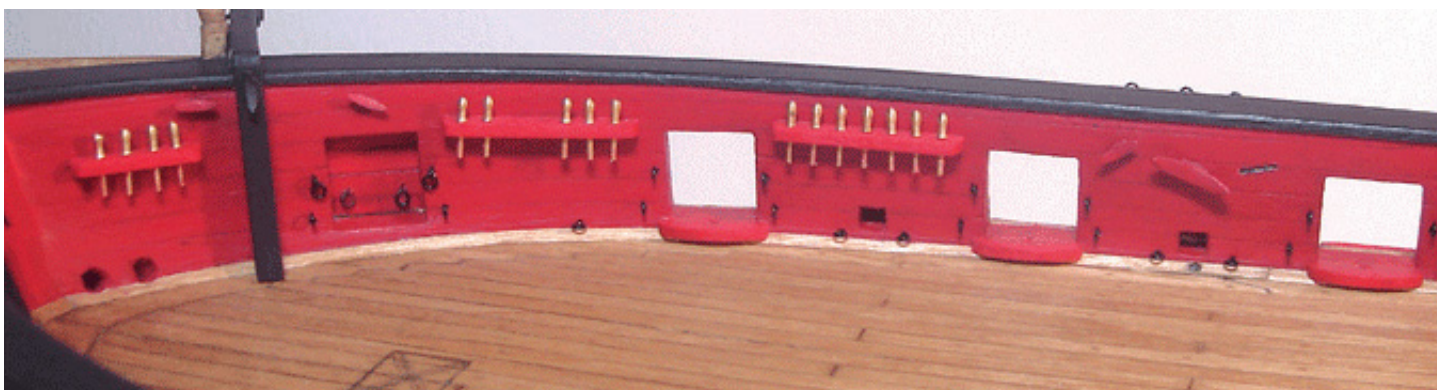





around 3" thick. This would be better represented if 1/32" thick rails were used on the model. However using such thin pin rails on the model would increase the possibility that they would break or pull free from the bulwarks. If you are concerned about the actual scale appearance of these fittings and want to go thinner, then you could sand the thicker rails a little bit, but 1/32" thick is probably too fragile to use. Either way, you should pin the rails into the bulwarks for added security. Simply drill a couple of holes along the edge of the rail and insert a length of wire or a wooden dowel into them. Make the pins long enough that 1/16" of each pin can be inserted into a corresponding hole drilled into the bulwarks.

Belaying pins are inserted into the holes you will drill along each pin rail. These holes are approximately 1mm in diameter. The belaying pins can be painted black or made to look like wood. The choice is yours. Use the belaying plan to find the locations for the pins. You only need to place them where a rigging line will eventually be belayed. A few others can be shown but you don't really need to fill every rail with pins. See the photos throughout this chapter.

In order to finish up the bulwark details many eye bolts and cleats need to be glued into position. Use the inboard plan to find the locations for them. There are two sizes of cleats (5mm and 10mm). Those shown over the aft-most port and bridle port can be made even smaller. The cleats can also be pinned into the bulwarks for added strength. Paint them black, red or to look like wood. The choice is

up to you. Here is one note about those cleats over the bridle port and aft-most port. There are two plausible ways to model them. The rigging line used to open and close those port lids could have led through a hole in the bulwarks or they could have simply ran this line over the rail. The location for these cleats will depend on which method you ultimately choose. If you decide to run the line through the bulwarks, the hole should be drilled directly above each port. The cleat would then have to be moved to either side of this hole accordingly. But if you plan to show this line seized to the eyebolt of the lid and run over the cap rail, the cleat can be centered above the port opening inboard. Both scenarios are equally plausible and you can choose which method appeals to you most.

The inboard side of the stern requires much of the same detailing. There are more eye bolts and cleats to add which are shown on the belaying plan. In addition to these, there is the traveler for the boom sheet. This is the bar above the rudder head. It was made from 22 gauge wire and glued into pre-drilled holes. A 1/8" double block was then stropped to it as shown in the photo provided.

**Carronade Construction...**There were sixteen 24lb carronades on the Syren when launched. Paint the carronades black and set them aside while building the sleds for them. Drill a hole in the arse end of the carronades for the breech line ring. The metal casting is very soft and this should not be difficult to do. Then insert an eye bolt into the hole which will simulate the breech line ring. You will need to shorten the tail of the eyebolt since only a short

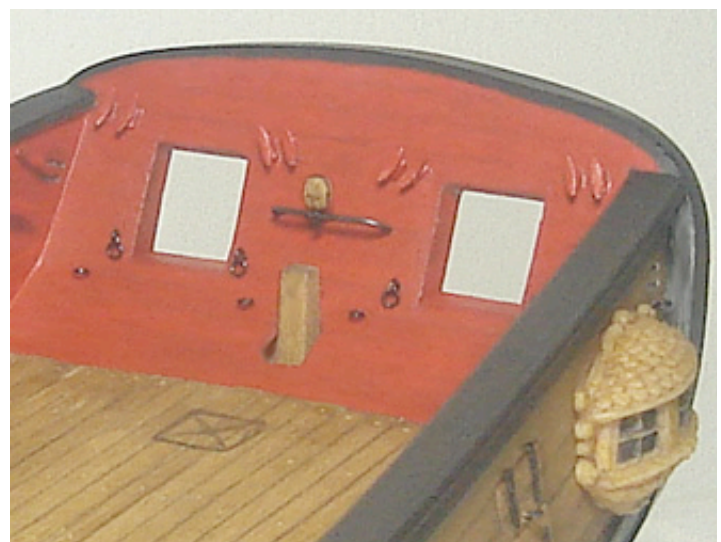



## Carronade Construction

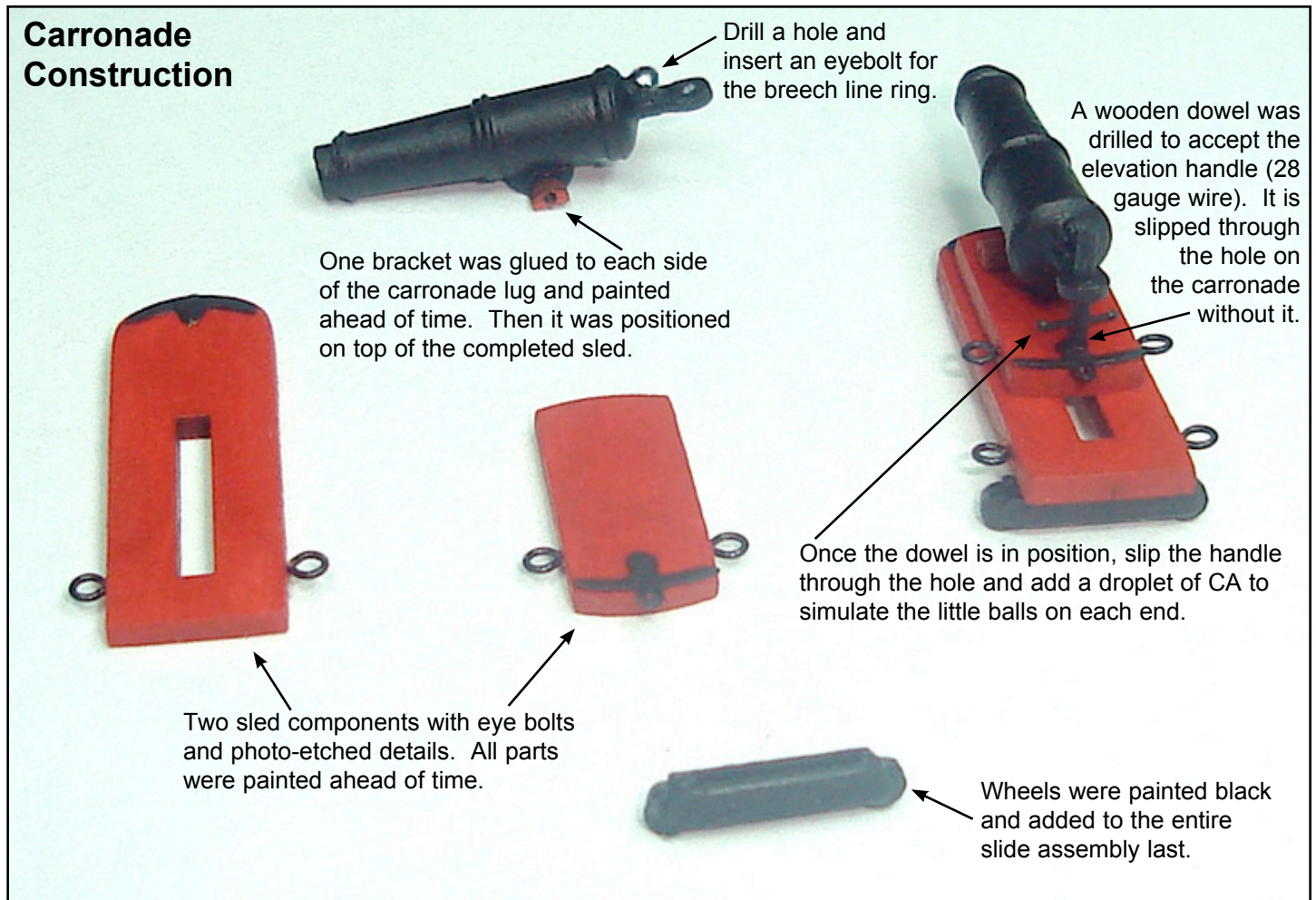

piece is needed. Glue the eye bolt in position before you paint them.

The sleds for the carronades have two major components. There was a longer base which has a slot for the smaller carronade mount to slide on top of. Both will be 1/16" thick on the model. Paint both of these elements red. Before you glue the carronade mount on top of its base, glue the four eye bolts and photo etched details to them. These features are painted black as shown in the photo provided. These two pieces can now be glued together. Set them aside for the moment.

On the bottom of each carronade you will see the "lug". This was used to secure the carronade to the sled. It was placed between two brackets on the sled and a pin was run through all three. The brackets are laser cut from 1/16" thick basswood. You don't have to show this pin,

but in the end the level of detail you decide to model is up to you. It will depend on your level of experience and how comfortable you are working with such small parts. It is much easier to glue these two brackets to each side of the carronade lug first. Then glue the carronade to the top of the sled. But before you do this, take each carronade and test it in each port opening to check its height. The carronade muzzle should be centered within the port opening

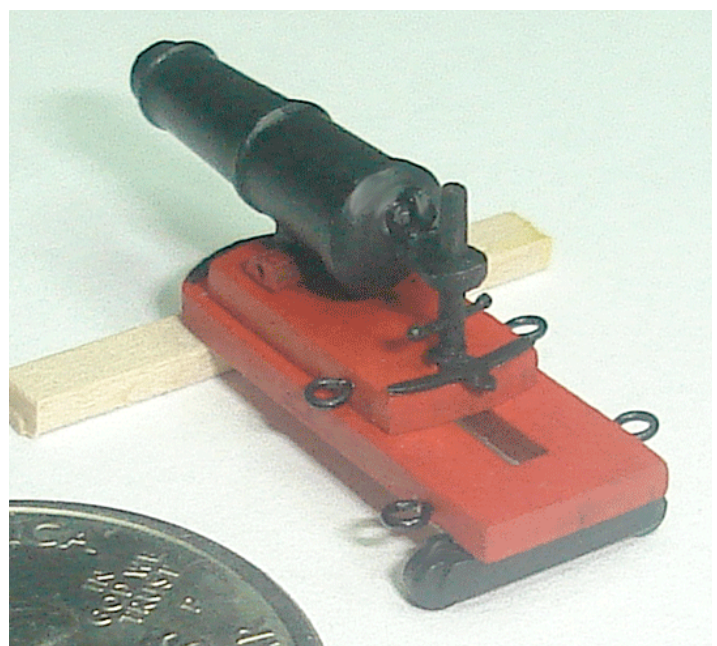
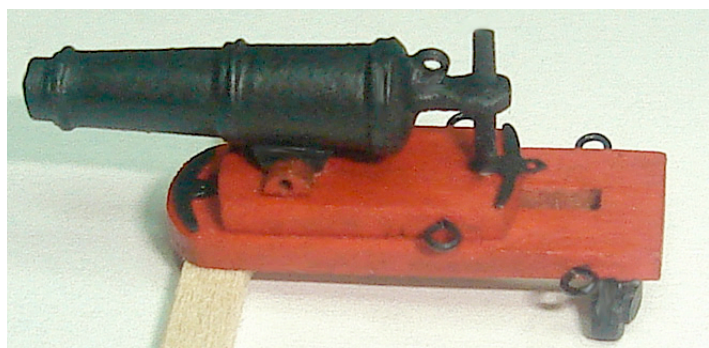



## Gun Tackles and how to build them.

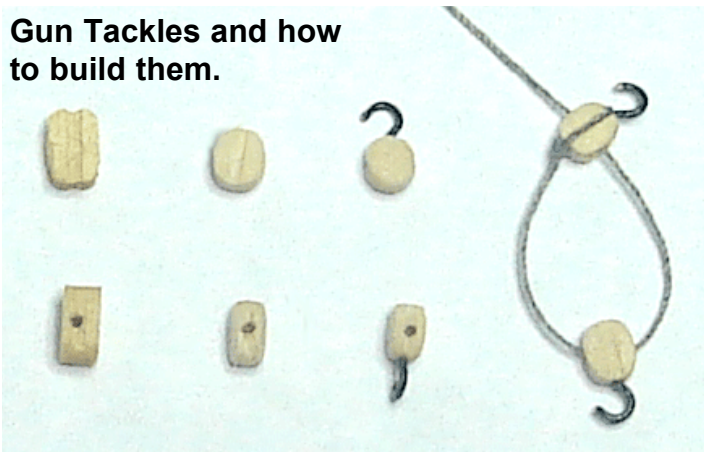

or nearly so. Place the sled temporarily into position and hold the carronade on top so you can see how it looks. If the carronade sits too high in the port opening then simply sand the bottom of the lug until it looks right. Then you can glue the brackets on either side of the lug and then glue the carronade to the top of the sled. Be careful to line up the carronade so the elevation screw will be positioned directly over the photo etched plate on the sled. See the photos for details. We will create the elevation screw next but the carronade should be glued into position on the sled first.

To complete the entire carronade assembly a few details remain. The carronade was elevated with the use of a screw. The screw passed through a threaded hole at the back of the carronade and rested on an iron plate. The screw was turned using small handles that extended out from the base of the screw. You can see these details on the plans and in the corresponding photos.

To simulate the elevation screw you can use a small wooden dowel or toothpick cut to length. Shape it until it fits through the ring on the carronade and sits comfortably on the photo etched plate. But don't glue it into position just yet. Drill a small hole through the elevation screw at its base. We will insert a small length of 28 gauge black wire through this hole to simulate the handle of the eleva-

tion screw. But this must be added only after the screw is glued into position on the carronade. After you drill the hole go ahead and glue the screw on the carronade assembly. Then insert the 28 gauge wire into position by pushing it through that hole. These are quite small so you might need to use a set of tweezers. Finally, to simulate the "ball-like" handles on the end of the wire a droplet of super glue was added and left to dry completely before painting. These droplets of CA can be added with the help of an applicator. The applicator can be something as simple as a tip of another length of wire or awl. Just touch the end of the handle with the applicator until a droplet of glue is transferred onto its end. Don't touch it too often as it will ruin the perfectly circular shape of the droplet as the glue dries.

The final detail for the sleds would be to add the casters or wheels to the bottom of the inboard side. See the photo provided. When the carronade assemblies are finished you can glue them into position on the model.

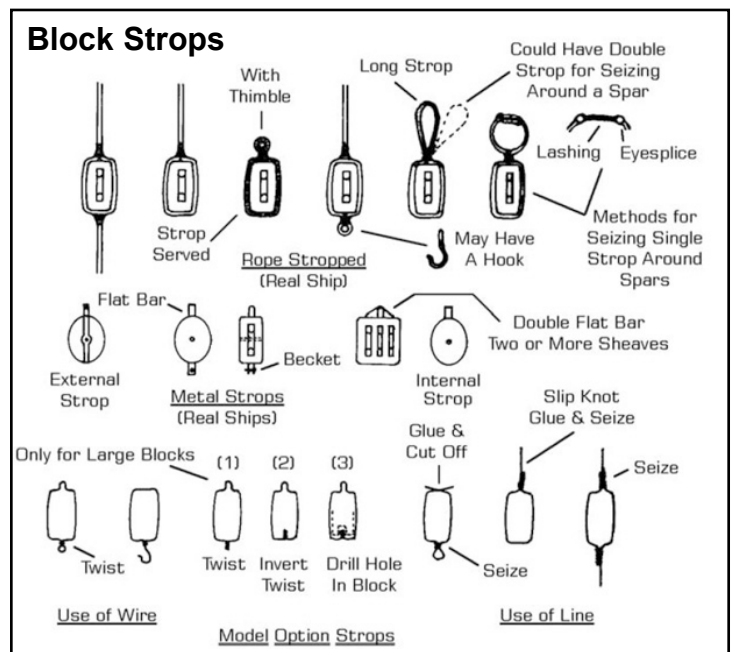
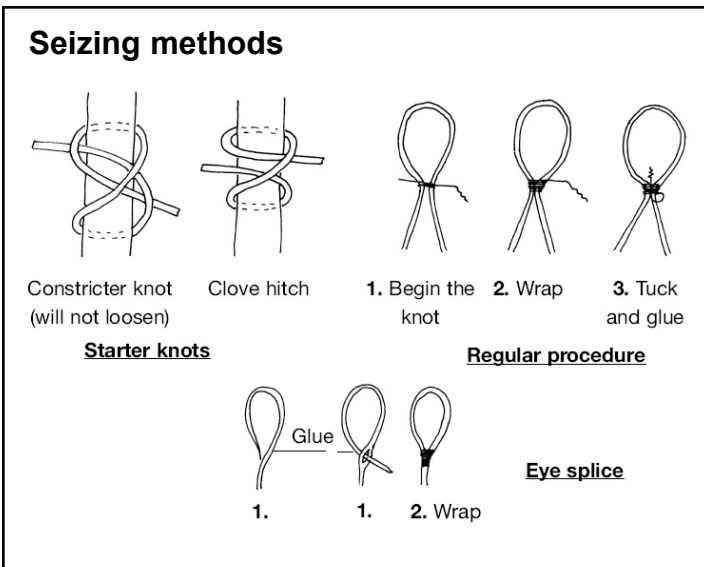



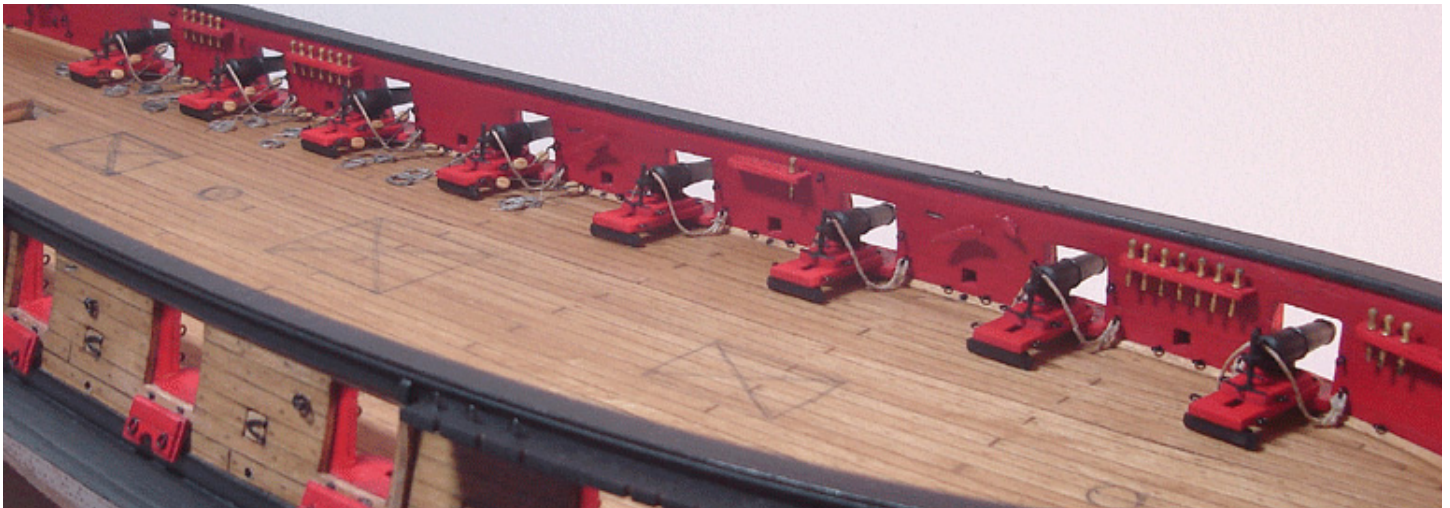

### Rigging the Carronades...

Before you start rigging the breech lines and tackles for the carronades please note that many options exist. At 3/16" scale, rigging all of the details as they would exist on the real ship becomes difficult. Depending on your skill level you may opt to omit some features. For example, you may only want to show the breech lines for the carronades and not the tackles. If you do decide to rig the tackles, maybe you will do so without the hooks shown on the prototype. Rather than actually seize the lines to the blocks or stop them according to actual practices, maybe a simple overhand knot will do. Read through these instructions carefully and then decide on just how much detailing you "can" or "want to" show.

The breech lines were completed first. These are the heavier ropes that secured the carronade after it was fired. Tan .028 rigging was used for the breech ropes. One end is seized to the lower eye bolt on each side of the port opening. Then it was taken through the ring on the carronade and set up similarly to the other side. But before seizing the other side of the line, attempts were made to make the breech line hang properly. At this scale they will have a tendency to flip up rather than hang naturally. The breech line should not be pulled tight. Instead it should be left slack if the guns are run out. So in order to make them hang naturally, a drop of glue was used to secure

them to the deck. This was done on one side of the carronade before the other was even seized to the eye bolt along the bulwarks. After one side is secured and hanging properly it is easier to establish the correct length and "slackness" of the breech line on the remaining side.

Tackles were used to pivot the carronade sleds from side to side. Another tackle (the outhaul) was used to pull the cannons into firing position. Two pairs of these are used on each carronade. This means you will need to create four tackles for each gun and a total 64 tackles in order to rig them all. Each tackle has two 3/32" single blocks with hooks stropped to each of them (128 blocks in all).

The typical "kit block" is somewhat square. The actual blocks were rounded and those supplied can be modified accordingly. This is of course optional since it isn't very enjoyable to sand blocks this small to their proper shape. But the difference will be noticeable. Whatever you decide, a small hook is shaped out of 28 gauge wire using needle nosed pliers. These hooks were glued into pre-drilled holes on one end of each single block. Use the end of the block that has the sheave hole closest to it. This is how it was done on the prototype but other methods can be used depending on your level of experience. As mentioned earlier, 128 blocks should be set up this way. Seize a generous length of .008 tan rigging line around one of those blocks. (See the photo provided) A

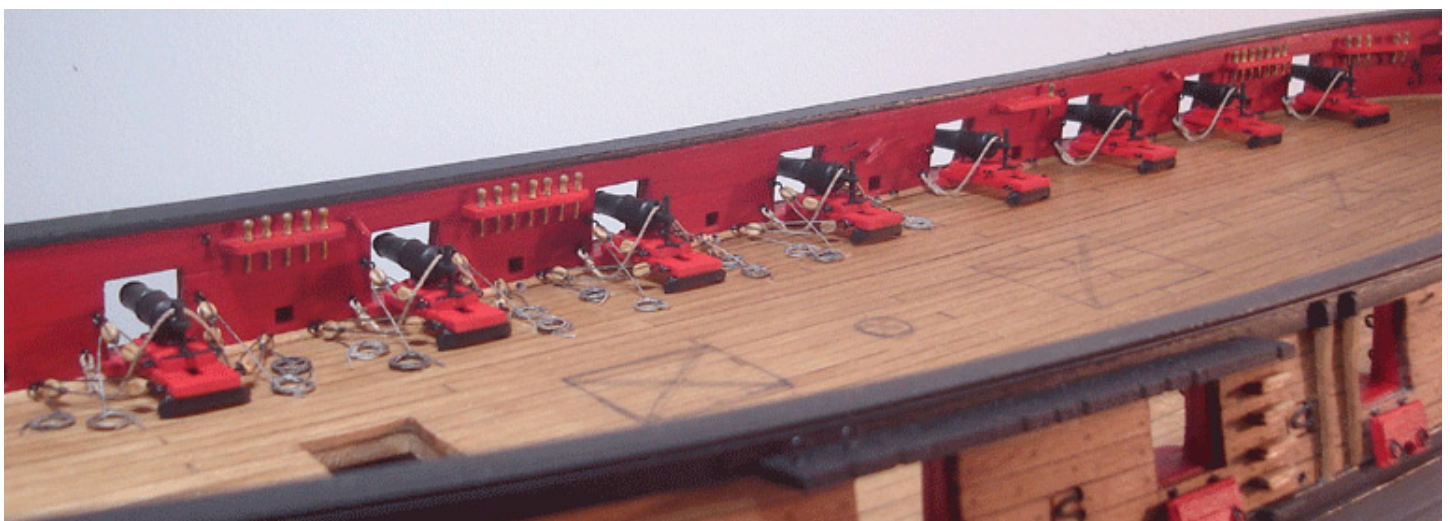

simple knot could also be used. Run the loose end of the line through another hooked block and then back through the sheave of the first one. This will complete your tackle which is now ready to be rigged on your model. Pay close attention to the direction of each hook on the tackles. It will make a big difference with how easy it will be to rig them. Although simulated, these are actually working tackles. Take a look at the photos that follow. Hook the tackle to the eye bolts along the bulwarks first and then use a tweezers to hook the other end to the eye bolts on the carronade sleds. Pull the tackles to tighten them up (remember they actually work). Then apply a drop of glue to the block on the bulwarks to hold the tension. Finally, the running end of each tackle can be cut so you can glue it

to the deck. A small rope coil is made and glued on top of this to finish it off. Once again...examine all of the photos and take your time. Rigging the carronades is not a task that can be completed quickly. But it is easier to do now before any other deck structures make it more difficult. The deck is wide open and getting those tweezers into those tight spots will be easier. It is best to finish them all up now before moving ahead to the next chapter. Please note that the last two photos in this chapter show four carronades rigged with tackles and four rigged without them. Only the breech line is shown on the later. This was done to help you decide whether or not you want to rig the tackles. As always, the choice is yours.

## KNOTS FOR SHIP MODELS

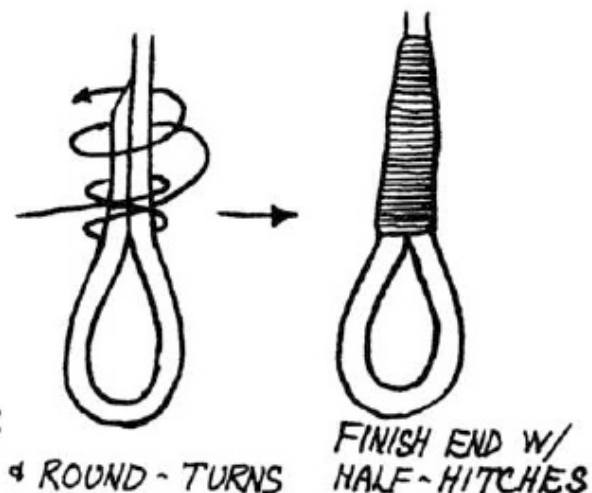
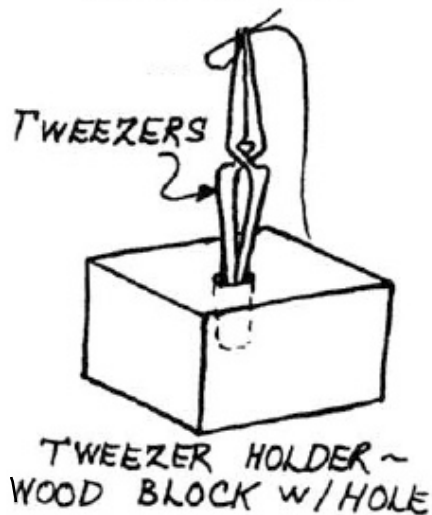
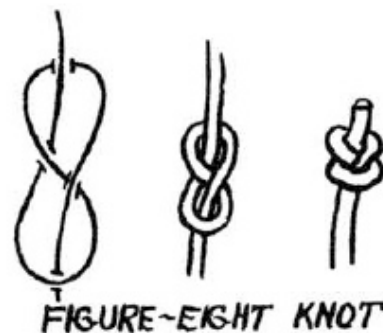
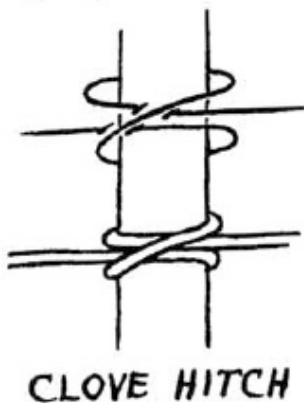
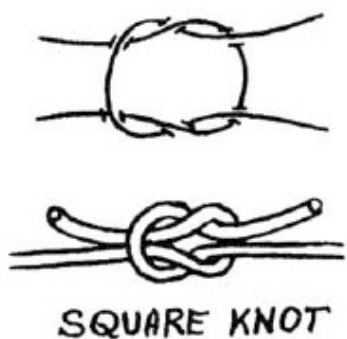
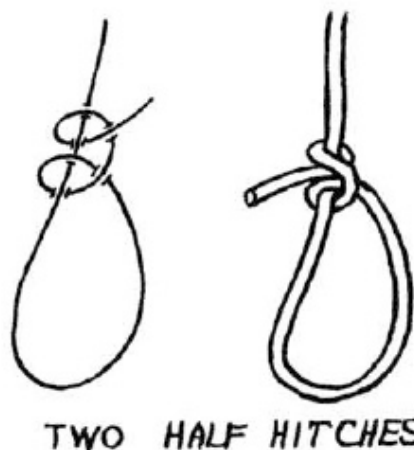
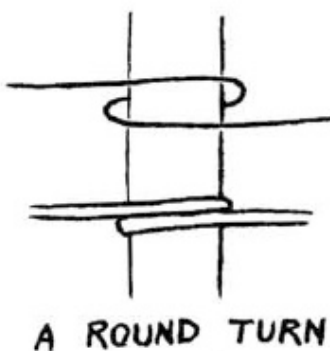
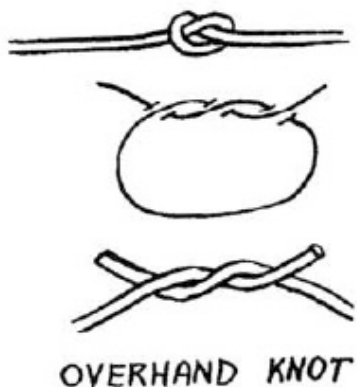



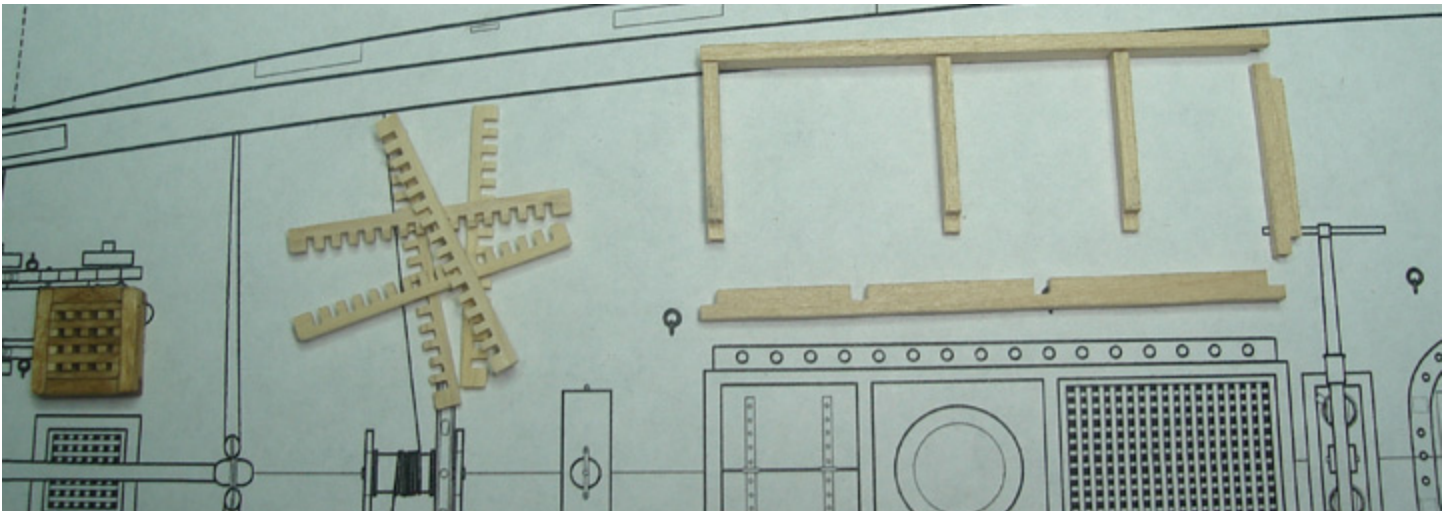

## Chapter Twelve Starting the Deck Fittings

You can now dedicate your time to building all of those wonderfully detailed deck fittings on the Syren. The pumps, binnacle, hatches, bits, ship's wheel and companionway will create interest for anyone who examines your model. Each fitting should be treated as a mini modeling project of its own. Take your time adding as much detail as possible.

Before you begin however, it would probably be a good time to drill the mast holes. There are two methods that can be used. The first would be to drill deeper holes (about 1/2" deep) the same diameter as your masts. Using this method will give the masts a lot of stability. But the downside is you will have to be very careful drilling the holes at precisely the correct angles. The masts are raked at varying angles and once these holes are drilled it would be a challenge to correct any errors.

The second method would be to drill the mast holes smaller in diameter than the actual masts. The holes don't need to be very deep (1/4"). A small tenon will be carved into the base of each mast which will be inserted into each of these smaller holes. This method will give you the opportunity to adjust the angle of each mast before the glue dries. Yellow carpenter's glue would be the best choice for securing the tenons in the holes. It will give you sufficient time to make adjustments before it dries.

### Hatches and gratings aft of the main mast —

There are several hatches on the deck of the Syren. To build those aft of the main mast you can start by using 1/8" x 1/16" strips to make the coamings. The coamings are the frames for the hatches. The gratings or cover boards are supported on a ledge built up on the inside of these coamings. On the real ship, the corners of the coamings were formed with a lap joint. The ends were not butted together edge-to-edge or mitered. However it depends on your skill level whether or not you decide to construct them this way. Whichever method you choose be careful to glue the coaming sections together so the hatch will end up being square and not askew. Use a sharp #11 blade in your hobby knife to notch the coamings in order to form the lap joints. See the photo provided which shows the components of the larger coaming completed and being assembled. The smaller scuttle is also shown assembled in the same photo. After the coaming is glued together, the gratings can be assembled using the laser cut grating strips provided. The grating would normally sit on top of a ledge around the inside edge of each hatch opening. It isn't necessary to create this ledge on our model because the grating strips are already almost 1/8" deep. The center of the large coaming is filled with cover boards. The capstan will sit on top of these. Use 1/8" x 1/16" strips for them. Six strips were cut to length and then glued together edgewise. The resulting platform was sanded to fit the space on the coam-

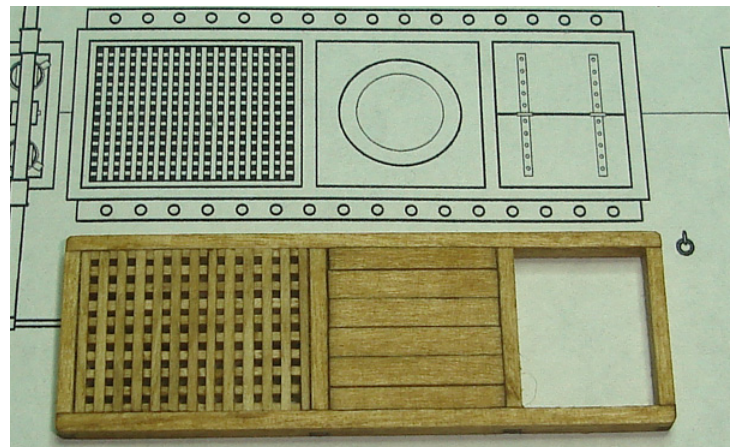
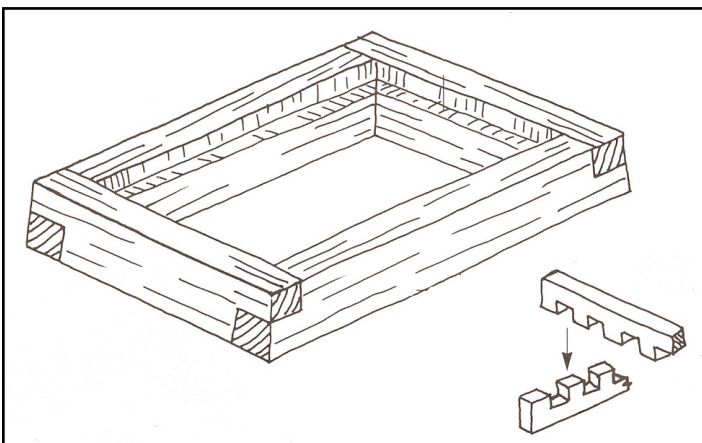

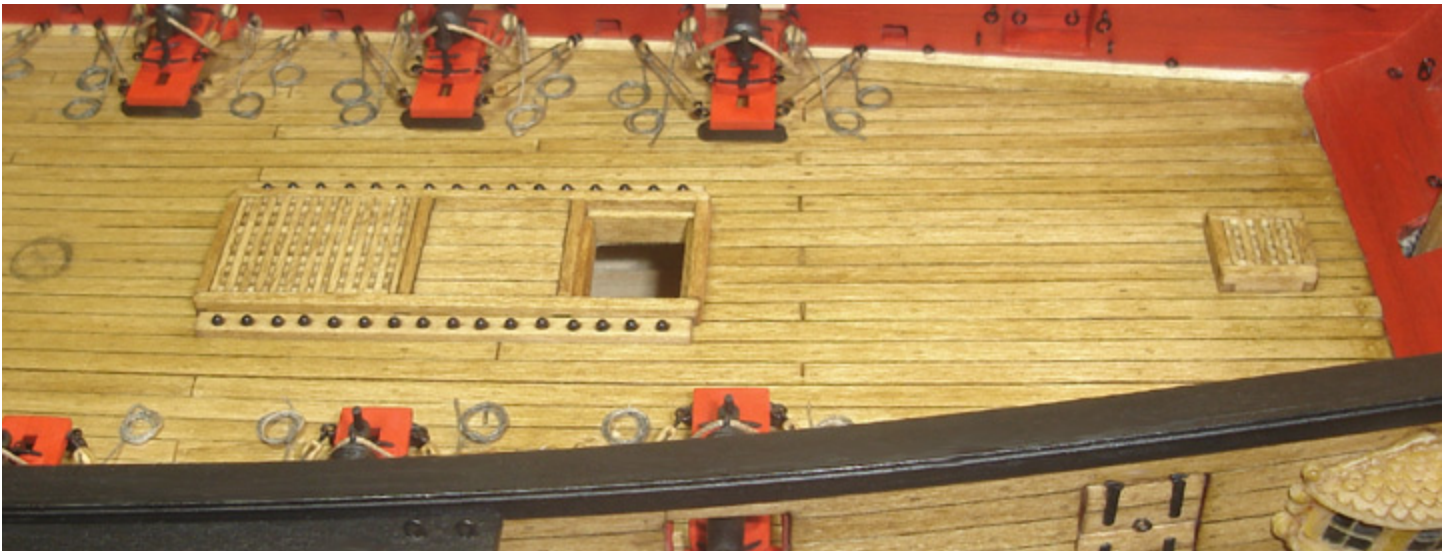

ing and glued into position. The smaller hatch on this assembly will be left open and the companionway will soon be built over it. See the photo showing the large coaming completed with the gratings and cover boards installed.

The deck is curved and has a distinct camber. The hatches will not sit properly on deck until the camber is sanded into the bottom side of each hatch coaming. Don't sand too much off at a time. The port-to-starboard camber is very slight. Test your hatch in position often to avoid sanding too much off. When the coaming sits properly on deck be sure to sand the tops of the hatch to match this camber as well. This will result in making your entire coaming slightly thinner but that's OK. The hatches on the actual ship were always constructed so they conform to the camber of the deck. When satisfied glue them on deck.

You will notice that the larger coaming has a shot rack on the both sides of it. These are made from a 1/16" x 1/8" strip. Small holes are drilled down the length of each shot

rack to accept the plastic cannon balls. The holes are not drilled entirely through the strip. You should only drill part way through creating a small divot. The 1.5 mm cannon balls are glued into these divots. Fill up the shot racks with canon balls and glue the racks alongside the coaming as shown in the photo provided. Before moving on to construct the capstan, 1/32" x 1/8" strips should be glued around the inside edge of the open hatch. You can see them in the same photo. These strips will finish off the inside of the opening nicely and form a ledge. The ledge is 1/32" deep and the companionway will sit securely on top of it.

### The Capstan —

The capstan is constructed of the many elements for the drum head and whelps shown on the inboard plan sheet. To avoid a blotchy finish, all of these elements should be stained prior to gluing them together. The capstan parts have been laser cut for you. The drum head is assembled first by gluing the two 1/32" circular pieces to the top and bottom of the "cog-like" piece (1/16" thick). A third slightly larger circle is then glued to the top of the drum head which will create a small overhang. To complete the drum head a final smaller circle is glued to the top of this. The edges of this smaller circled should be softened and not left with a hard edge. The capstan drum head is then glued to the top of a 5/32" wooden dowel cut to length. See the photo provided.

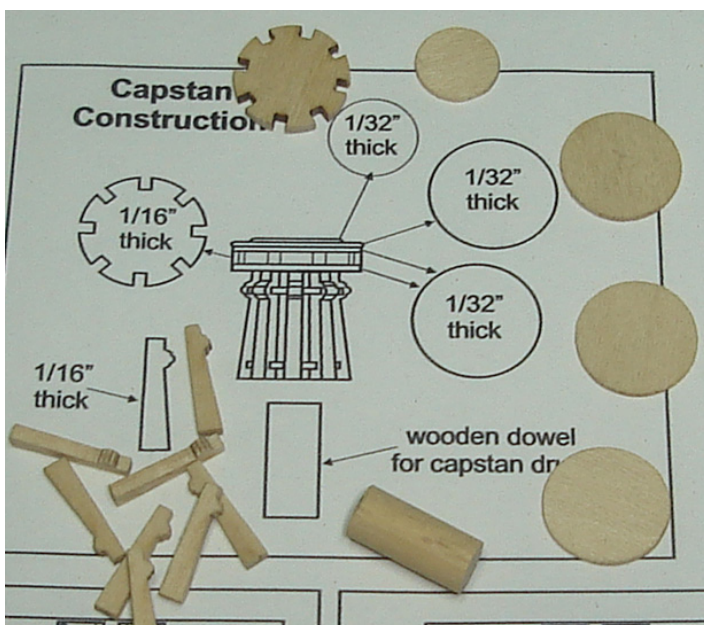

There are eight whelps (1/16" thick) that are glued around the drum. Be careful to space them evenly around the drum. To complete the capstan, two rows of chocks (1/32" thick) are glued between the whelps. The first row is located just below the drum head and the second is located just above the base of the capstan. These chocks are very tiny and can be tricky devils. Keep them aligned at the same height as they work their way around the capstan. The chocks are pie shaped and can be cut from a strip of 1/32" x 1/8" wood. Stain the entire strip before cutting your chocks. This will help you keep a consistent finish to your capstan. You can also paint certain elements of the capstan to help emphasize them. The chocks and



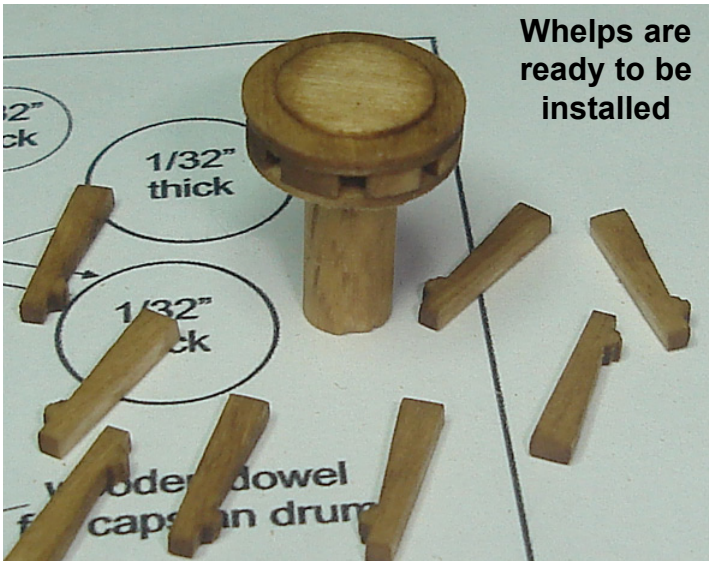

Whelps are ready to be installed

the small circular top were painted black on the prototype but in the end the choice is yours to decide. See the photo provided showing the capstan glued into position on the model.

**Ladder for the companionway —**

The inboard plan contains a template for making the ladder. The sides and steps of the ladder are cut to length from a 1/32" x 1/8" wood strip. The sides were placed on top of the plan so the locations of each step could be transferred to them. See the photo provided. The six steps were all glued to one side of the ladder and left to dry. The remaining side was added afterwards. Small grooves can be filed into the sides of the ladder if you wish to have a guide for the placement of each step. Just file along the reference lines you just transferred from the inboard plan. But at 1/32" thick be careful not to file all the way through them. Carefully glue the ladder into position on the starboard side of the open hatch on deck.

**The companionway —**

The companionway can be built in three steps. For step one cut the necessary 1/32" thick strips to length in order to construct the sides for the companionway. These strips

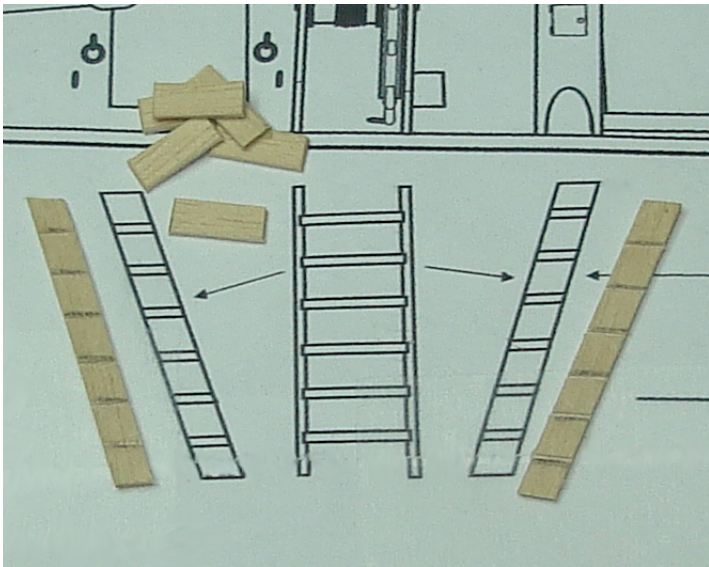

should be glued together edge-to-edge as shown on the inboard plan. You can run a pencil down the edge of each strip before you glue them together if you wish to emphasize the seams between each plank. Test each side in the opening of the hatch for a proper fit before you glue them together. You can see in the photo provided that the sides of the companionway were glued together off of the model. This will make it easier to finish step two and three. Keep testing the companionway in the hatch opening periodically as you glue each side together. Make any adjustments needed as you progress.

In step two, the top of the companionway is completed. Glue more 1/32" thick planks together edge-to-edge in order to make the larger fixed side of the companionway top. Even though you won't see them, two photo etched hinges are glued to the top if it. Glue a tiny length of 28 gauge wire along the edge of each hinge strap to simulate the hinge pin. This is an important detail because the hinge pins will raise the lid of the companionway slightly making it look more realistic in its open position. Glue this half of the companionway lid on top of the structure. It should overhang the edges slightly as shown on the plans. Glue a 3/32" wide strip down each side of the open portion of the companionway. These strips should also match the overhang you created with the lid on the port side of the companionway. See the photo provided showing how it looks at this stage. The companionway is not glued onto the model yet.

The final step would be to create the lid and doors for the companionway. The lid is made so it would theoretically fit the open space provided for it if the lid were closed. You don't have to glue the photo etched hinge straps to the lid seeing as they won't be seen. Simply glue the lid into position after you make the handles for it. They are the same type of handles that were made for the gun port lids using an eye bolt bent over. They should be painted black. The doors are made the same way. Keep in mind the doors should be slightly shorter than the companionway to account for the depth of the companionway as it sits in the coaming. Don't make the doors so long that they



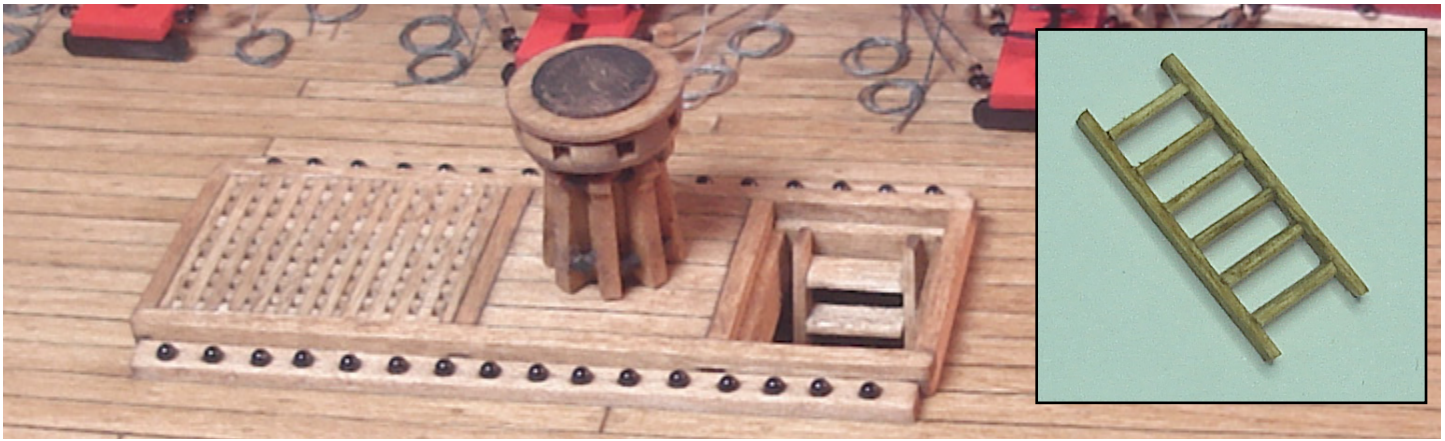

are even with the bottom of the companionway. Glue the hinge straps onto each door after you bend them. Each hinge is bent so there is a little extension on each of them. This extension will be glued to the companionway itself as shown in the accompanying photo. This is how you will attach them. A tiny length of 28 gauge wire can be glued into the fold of the hinge to simulate the hinge pin. A handle is added on the outside of each door as well. When constructing the doors make sure they are the proper width. Would both doors fit the opening of the companionway if they were closed? Glue the companionway into position by resting it on the ledge you created within the hatch opening.

below. These pieces are quite delicate so be sure to handle them carefully.

The top of the binnacle (1/32") is glued into position. The edges were beveled first as shown on the plans. The doors were also glued on the binnacle along with the two decorative kick boards between the legs. See the photo below. Three small air holes were drilled just above the doors on each side of the binnacle. These compartments are where the lamps were kept. An open flame/lantern was used and ventilation was required to keep them lit.

#### The binnacle —

The binnacle is located just aft of the companionway. It housed the compass for the ship. The main structure of the binnacle is created by cutting a 3/16" x 3/16" strip into three pieces. Use the inboard plan to cut them to their correct lengths. Glue them together as shown in the photo below. Stain all elements of the binnacle before you glue them together. This will help keep the finish consistent because the glue might change the porosity of the wood and make it appear blotchy.

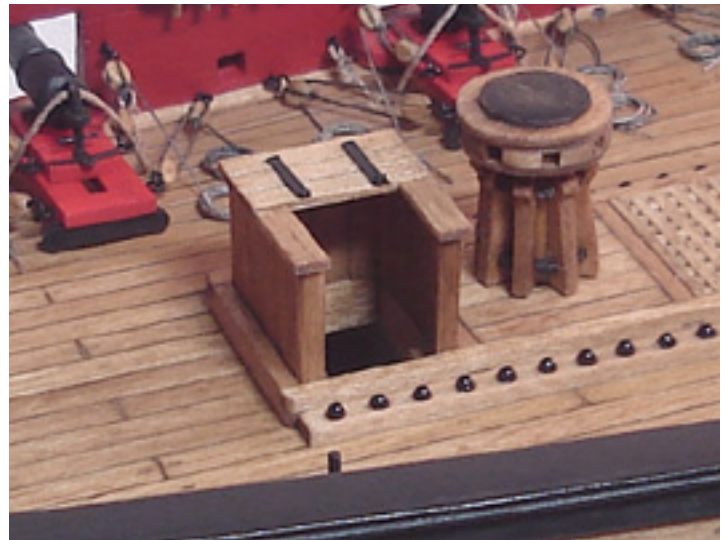

The back and sides of the binnacle are 1/32" thick. These pieces have been laser cut for you. Glue the back of the binnacle into position first followed by each side as shown

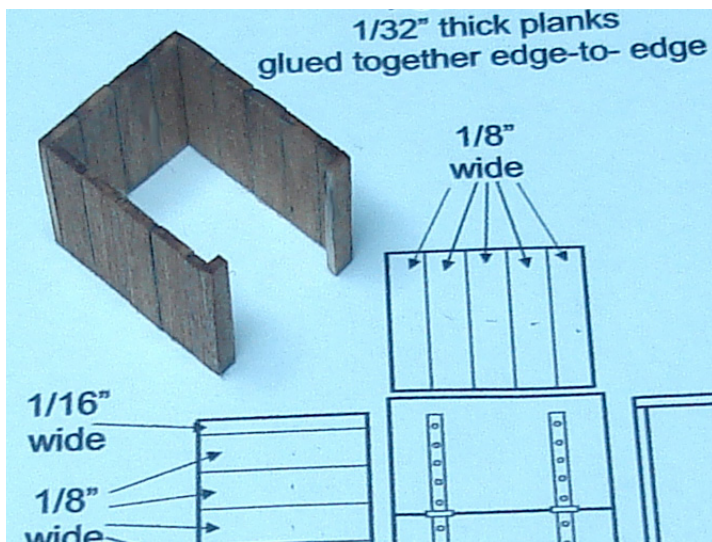



To finish off the binnacle, tiny handles were made for the drawers. Small brass nails were trimmed so the heads could be used to simulate them. The drawers sometimes had no handles at all. Instead they were opened by inserting your finger into a small hole bored into them. It is very difficult to create knobs or handles at this scale which don't look too large. So this method would be acceptable as well. You can see in the photo below that this was the method used for the doors on each side of the binnacle. The choice is yours. A small disc of wood can be cut to fit in the center compartment of the binnacle to simulate the actual compass. Paint it to resemble brass.

Every ship had a bell. The Syren was no exception. They were often located on the top of the binnacle. The framework to hang the bell is made with 28 gauge black wire. See the illustration on the next page which shows how to create this stand. Test fit the stand on the binnacle to ensure it is the proper height and keep in mind the size of the bell that will hang from it. Paint the bell to look like brass and glue it onto the stand as described in the same illustration. Don't glue the stand on top of the binnacle until after the bell is in position. It is easier to glue the whole assembly on top as one unit. This process can be a bit finicky because of the small scale of our ship model. If it proves to be too much of a challenge based on your level of experience the bell can be omitted from the binnacle.

Before you glue the finished binnacle on deck it should be noted that it was secured to the deck with wooden battens. Glue a (1/32" x 1/32") strip to the inside edge of the binnacle's legs as shown on the plans and the final photo below.

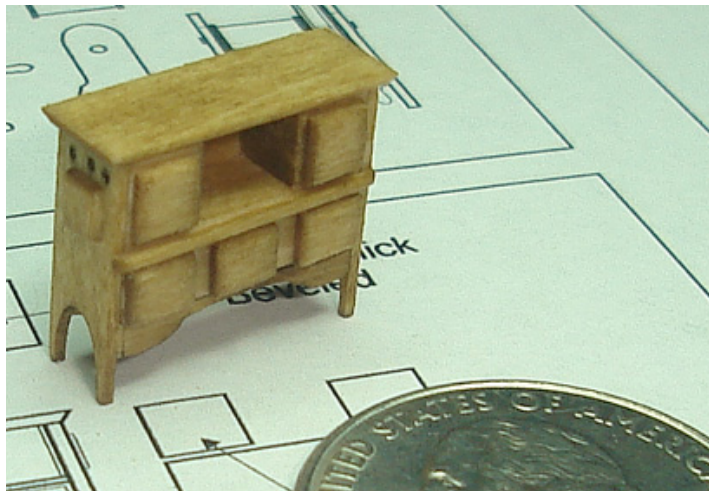

**Glue or solder two lengths of 28 gauge wire in the center and bent the ends as shown.**

**Then bend the entire wire frame to shape as above. The ends of the wire should be bent to form the legs. The bell can be glued in position after sanding the loop at the top of the bell so it is open. This will give you enough surface to glue the bell to the underside of the wire stand.**

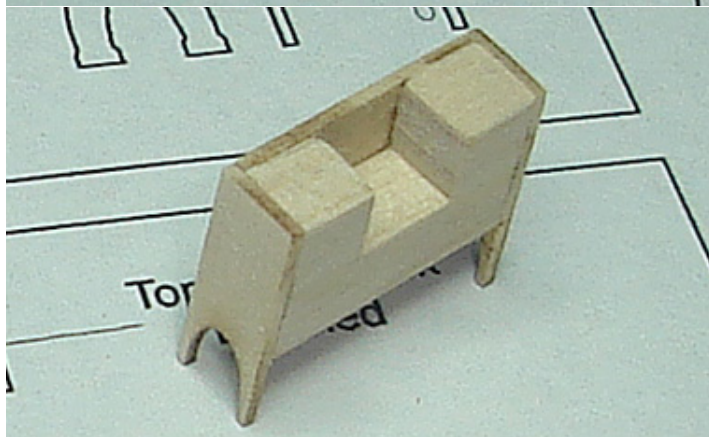
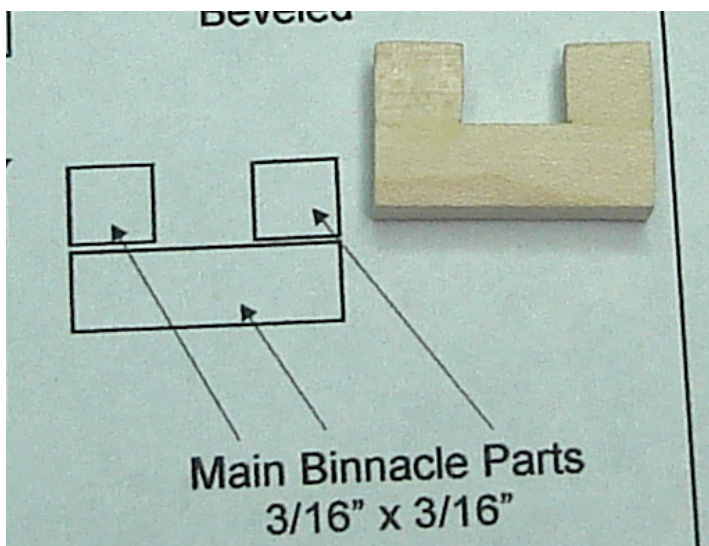



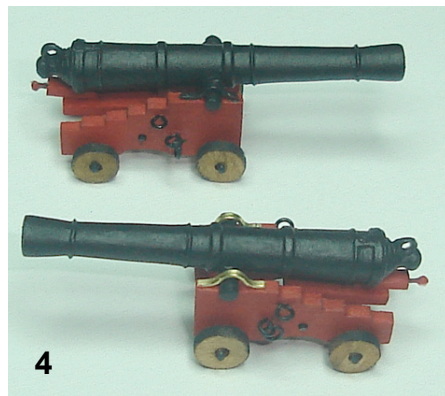
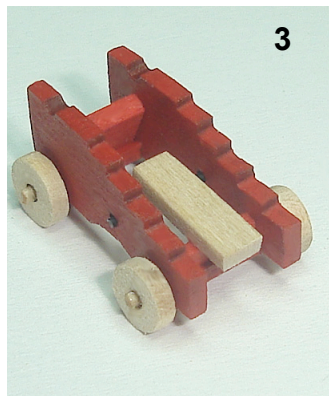
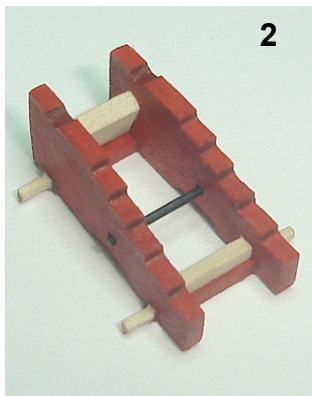
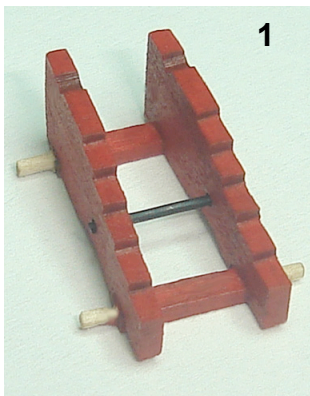

### The 12 pounder long guns and carriages —

The Syren carried two long guns as stern chasers which are positioned at the stern. To build the carriages for the long guns follow these 4 steps.

**Step one** — Paint the carriage brackets and axles red. These elements were laser cut for you. Sand the axle extensions so they are rounded to accept the trucks (wheels) later. Assemble the axles and carriage brackets to form the basic carriage design. While aligning the four pieces make sure the correct axle is placed up front as it is shorter than the rear axle. The carriage should taper and become narrower towards the front. All of these elements are 1/16" thick. When the glue is dry cut some 22 gauge black wire to length to use as the support rod. This rod is slid through the hole on the carriage brackets and spans across the carriage as shown.

**Step two** — Paint the transom and bolster pieces red. They are not painted yet in the photo so they are easier for you to see. The transom (1/16" thick) is glued into position at the front of the carriage. It is placed on an angle which is shown clearly on the plans. The bolster (1/16" thick) sits right on top of the rear axle. It is centered front to back on top of the rear axle.

**Step three** — The trucks (1/16" thick) are glued onto the carriage axels. Note that the front trucks are slightly larger than those at the rear of the carriage. These are left natural and not painted. The stool bed (1/16" thick) is painted red and glued into position. The stool bed spans across the support rod and the bolster as shown. The back edge of the stool bed lines up with the back edge of the carriage brackets.

**Step four** — Drill a hole in the arse end of the cannons for the breech line rings. Insert an eye bolt in each hole to simulate the breech line rings just like you did for the carronades. Remember to drill a hole for the breech line ring. Then insert an eyebolt to be used as the ring for the breech line. This is the same thing you did for the carronades earlier. (After painting the cannons black you can place them in the carriage.) They are secured to the carriage with an iron bracket called a 'cap square'. The cap square can be simulated by using a brass strip that is 3/64" wide. Bend it to shape as shown in the photo. The cap square is not yet painted on one of those carriages

so you can see it clearly in the last photo. The quoin is a wedge shaped piece of wood with a handle and was used to raise and lower the cannon's muzzle. A tiny brass pin can be used to simulate the handle for the quoin. It is also painted red. Glue it on top of the stool bed under the cannon...but only after determining the proper height of the cannon's muzzle so it will be centered in the stern ports as much as possible. To finish everything up there are two eye bolts on each side of the gun carriage. The lower eye bolt also has a split ring on it. The breeching will pass through this split ring when you rig the cannons.

**Rigging the Long Guns** — Use .028 tan rigging line for the breeching on the long guns. Seize one end to the eyebolt on the stern as shown in the attached photo. Run it through the split ring of the lower eye bolt on that side of the gun's carriage. From there it works its way through the ring on the breech of the cannon. Then continue to rig the breech line on the other side of the carriage in the same way and seize it to the corresponding eye bolt on the stern. Note in the photos how the breeching is left slack and not pulled tightly. There are also two tackles (one on each side) for each carriage. They are made the same way as those for the carronade sleds. Use 3/32" single blocks which are hooked to the eye bolts as shown in that same photo. Use .008 tan rigging line for them. Finish them off with some rope coils on deck.





**The Ship's Wheel** — The ship's wheel is supplied as a metal casting. It can be painted to look like wood with an iron ring on both sides which would have secured all of the elements together. There are two support posts which are 1/16" thick and laser cut for you. These posts supported the wheel and drum so it could be revolved around a spindle. Twenty-two gauge black wire is used to simulate the spindle. The drum is a 5/32" diameter dowel cut to length. A 1/32" thick disc is glued to each end of the dowel to form a lip. The discs were also laser-cut for you. They are slightly larger in diameter than the dowel. You can see all of the components that make up the ship's wheel in the photo provided.

The components can be assembled by inserting a length of that 22 gauge wire into a pre-drilled on both end of the drum. You don't have to use one length that goes completely through the drum. Simply glue two smaller lengths into a hole on both sides. Then slide the wheel onto one side followed by one of the support posts. The support post can be glued firmly onto the wire to secure the wheel in position. Trim the wire to the appropriate length afterwards. Glue the remaining post on the other side of this assembly in the same manner. To finish it off, two 1/32" x 1/32" battens are used to secure the whole finished wheel assembly on deck. This is the same method that was used to secure the binnacle on deck. See the photo that shows the completed wheel glued into position just aft of the binnacle. Stain all of the components before you glue them together. This will again prevent the stained finish from appearing too blotchy.

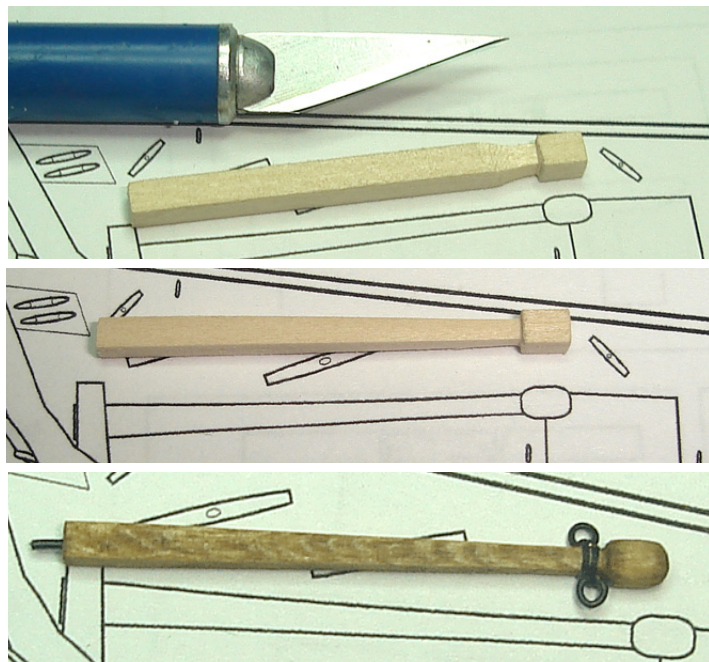

**The Tiller** — The tiller is shaped using a single 1/8" x 1/8" basswood strip. The photos provided show the tiller being carved to shape. This can be done using a sharp #11 blade in your hobby knife. Sand it smooth when finished. Don't be afraid to thin down the tiller to about 1/16" thick just as it meets the "ball-like" forward end. The tiller should not look too thick and chunky. Two split rings are lashed to the end of the tiller as shown in the last photo. The tiller rigging will be hooked into these rings on both sides. They should be painted black.

The rigging for the ship's steering mechanism consists of six 3/32" single blocks stropped with hooks. Check the plans for their placement. Seize a generous length of .008 tan rigging line to one of those hooked blocks. This block is hooked to an eye bolt along the waterway just aft of the last gun port. From here the line is reeved through another block hooked to the split ring on the tiller and brought back through the same originating block on the waterway. Then it is run through a third block hooked to an eye bolt along the waterway just forward of that last gun port. Wrap the end of the line around the drum of the steering mechanism five or six times. To finish it off, take the loose end (hopefully it will be long enough) and complete the rigging on the other side of the ship following the steps in reverse. The line should end up being seized to the hooked single block on the opposite side of the hull from where it originated.

This is a tricky task and it would be best to immobilize the tiller beforehand so it can not swing from side to side. It will help you set up the necessary tension in this rigging as you proceed. Another method would be to rig each side of the steering independently. Rig the first side as described above but only wrap the line around the drum 3 times and secure it with some glue. Cut the excess off so the end of the line terminates on the underside of the drum and can't be seen. Then set up the rigging on the opposite side in

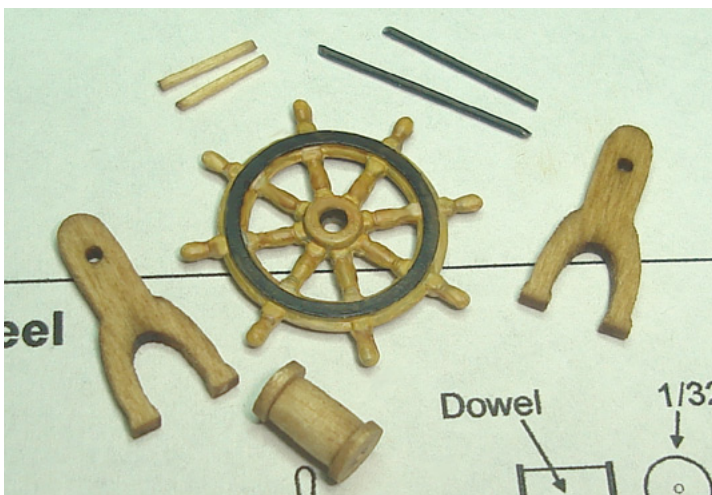



same manner and when wrapping the line around the drum make it so the end of the line terminates next to the other one. Because they meet on the underside of the drum it will be nearly impossible for anyone to tell you didn't use one continuous length of rigging to complete this task.

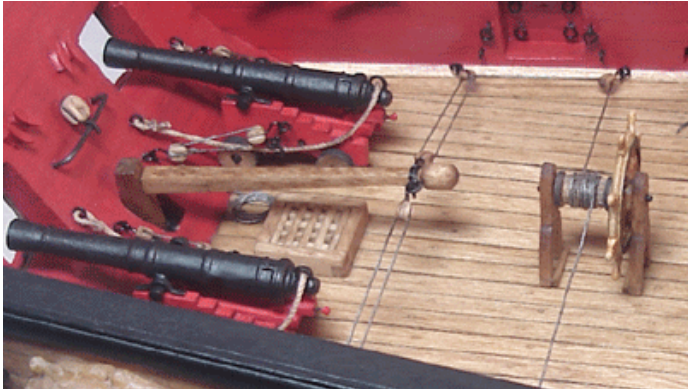

**The Pumps** — Components for the pumps are shown in the photo provided. Each component is best shaped ahead of time so the entire unit can be assembled in two sections later. It should be noted that the pump sits on top of a platform that is constructed much like the hatch coamings earlier. This time the coamings are constructed using 1/16" x 1/16" strips. The coaming for the pump is not as tall as those you made for the hatches. See the inboard plan for details. You can create lap joints at the corners. This frame is built around a 3/16" x 1/16" wood strip cut to length. You can see the finished platform in the same photo.

The pump drums are made by cutting a 1/8" diameter dowel to length. Drill the top of the dowel so the drum looks like a hollow pipe. Start by drilling a small hole about 1/16" wide. Then switch to a larger bit and drill the final sized hole. This hole does not have to be drilled straight through the drum. They will be painted black and it would be difficult to tell if they are or not. These drums can also be made using the appropriate sized brass or styrene tubes. You can see on the plans that the drums taper from a wider base and this can be easily replicated on our model. Simply wrap some 28 gauge wire around the base of the drum and secure it with some glue. This won't create the gradual taper so you will need to apply some wood filler around this rim with your finger. It will settle along the top of the wire to form the gradual taper needed. To finish off the drum add a smaller dowel for the pump spout and drill a tiny hole into the end for realism. Once this is completed the drums can both be painted black. You can see in the photo that one of the pre-assembled drums has not been painted yet. This was left unpainted to show you how they look prior to painting. You can see the black wire around its base.

The center post for the pump is shaped using a 1/8" x 1/8" basswood strip. The top is rounded off as shown and the center filed down to form the slot for the pumps crossbar. A hole is drilled through the sides of the slot because a pin will secure the crossbar in position later. It is best to drill the hole before you file the slot since the post will be less

fragile at that time. Glue the post to the center of the pump platform when it's finished. The two pump drums can also be glued into position on both sides of the post.

The pump's crossbar is made by cutting a 1/16" x 1/16" strip to length. Both ends of the crossbar have metal bands/sleeves used to insert the portable handles for the pump's operation. These sleeves are made by wrapping a paper strip around the end of the crossbar. Paint them black afterwards. You can see them in the photo provided. One sleeve was not painted so you can see how it looks. Heavier paper was used. Drill a hole through the center of the crossbar to finish it off.

Temporarily pin the crossbar into position on the support post using some 28 gauge black wire. Mark the locations on the crossbar for the locations of the iron brackets. They should be positioned directly above each pump drum. Remove the cross bar. The brackets are made by bending a brass strip (3/64" wide) as shown in the photo. Drill a tiny hole through the underside of these brackets. Paint the brackets black and glue them onto the crossbar. Temporarily pin the crossbar back onto the support post when it is finished. The final pieces needed to complete the pump are the two pump rods that extend from the brackets into each pump drum. Measure two lengths of 22 gauge black wire so that after they are inserted into pre-drilled holes on the bottom of the pump drums, they are long enough to also extend through the holes you made on the bottom of the pump brackets. Remove the crossbar and glue them into the pump drums. Then reinstall the cross bar being careful to insert both wires into the holes on the underside of each bracket. Insert the crossbar pin to lock the whole pump assembly together.

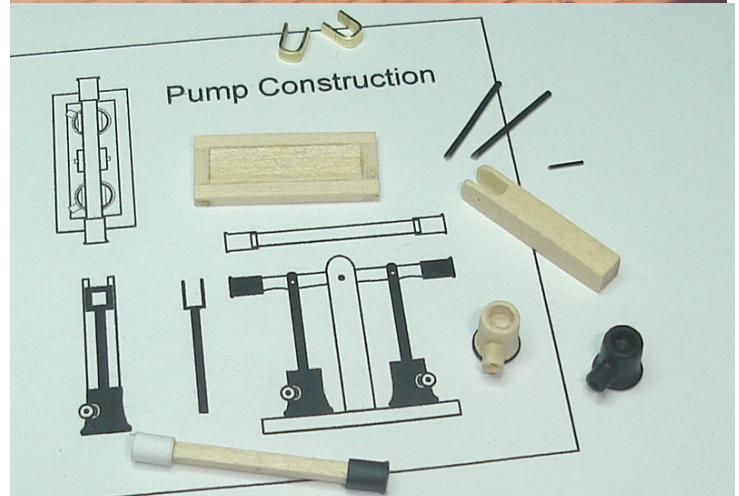
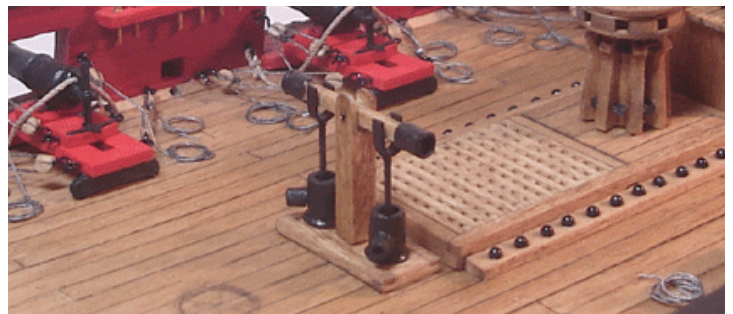



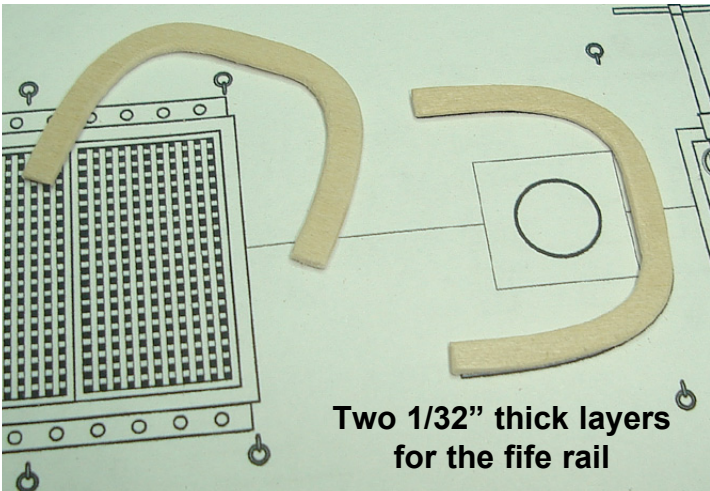

Two 1/32" thick layers for the fife rail

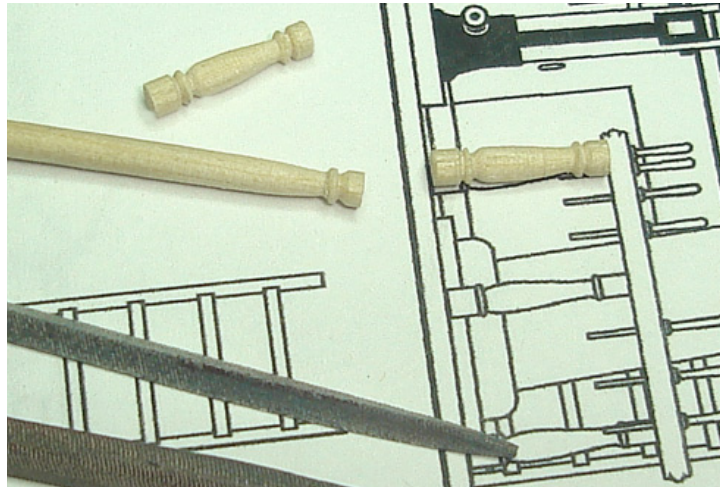

## Chapter Thirteen **Finishing the Deck Fittings**

There are many additional fittings forward of the main mast which will be built using the same techniques you used to complete chapter twelve. Others such as the fife rail will introduce you to some different techniques that will serve you well on future ship modeling projects. The construction of these fittings is described in detail below.

### The main fife rail...

You will notice in the photos provided that there is an elevated square section of decking where the main and fore masts are located. Before you start constructing the fife rail and other deck fittings it would be best to complete these thicker deck sections. This feature was a common detail on sailing ships and helped keep water from seeping into and around the mast wedges and coat. Glue five lengths of 1/8" x 1/32" wood strips together edge-to-edge to create a equal sided square. You can simulate the caulking between the planks with a pencil. Center the planked pad on top of the mast hole and glue it into position. Then re-drill and file the mast hole through the platform as shown in those same photos. Note how the planks on this elevated section run perpendicular to the deck planking.

The top rail for the fife rail should be assembled first. The rail is actually assembled with two layers of laser cut rail. The wood grain is aligned 90% on the second layer and once glued together it will be stronger and less likely to split.

Rather than just glue the two layers together as is, you can round off the inside and outside edges of each layer first. By doing so it will create a nice double beaded detail to the rail after they are glued together. You can see this edge clearly in the photos below.

Mark the locations for the belaying pins along the top of the rail. Drill them very carefully. Even with the laminate it is still possible that the rail could split along the grain of one of its layers. Sand both sides of the rail afterwards to smooth it out and thin it down slightly. Stain it when you are finished.

The six stanchions that support the fife rail can be produced in many ways. You should start with a round 1/16" dowel. Cut six pieces that are approximately 1" long. Hold

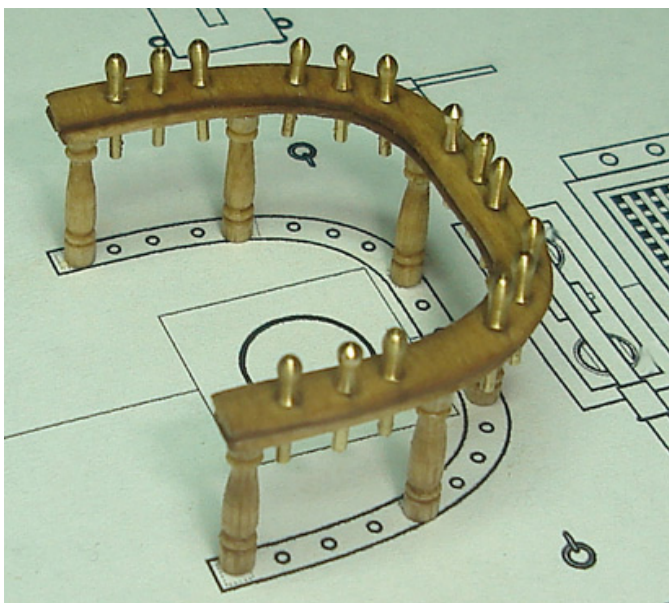

Completed fife rail



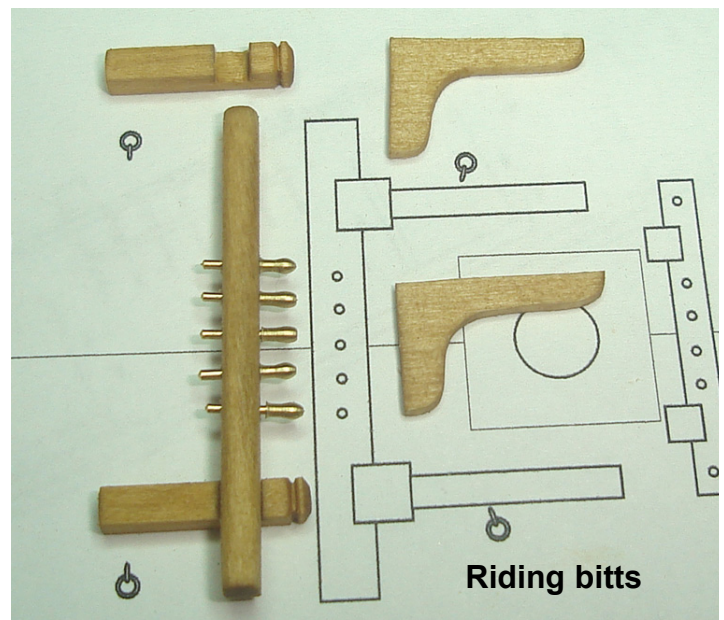
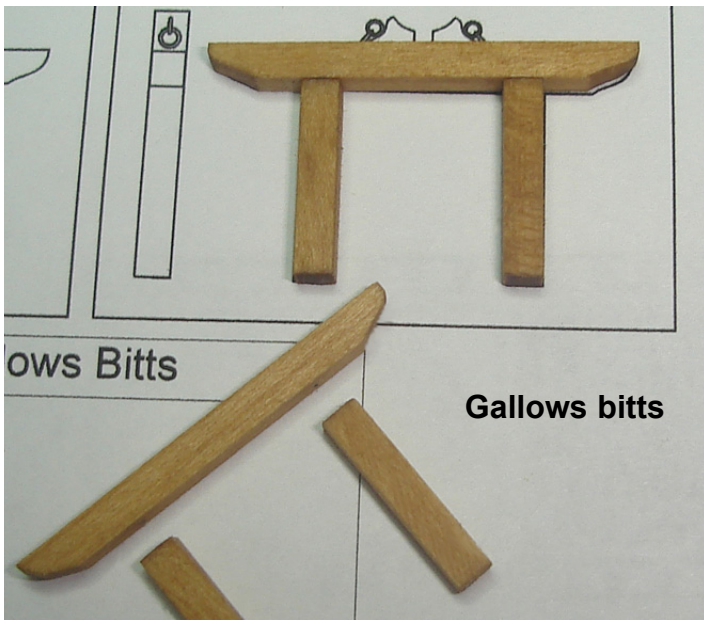

each piece against the plans and mark the locations where each groove should be sanded to establish the “fancy” profile of the stanchion. You can insert the extra long dowel into the chock of a power drill. After you turn the drill on, the reference lines should still be visible as the stanchion rotates at high speed in this “poor-mans-lathe”. Use some mini files and start making the grooves and shaping the stanchions to suit. This technique does take some practice but can produce some good quality work.

The other alternative would be to manually file the grooves into each stanchion without the aid of the power drill. Don't cut your dowel into smaller 1” segments. Use a longer piece several inches long. Mark your reference lines for the stanchion on one end of the dowel. Hold the dowel down with your finger (left hand) on a flat surface. Position a file on top of the reference lines with your other hand. Then you can roll the dowel back and forth on the flat surface with your finger while applying slight pressure to the file. This will slowly create the groove and “fancy” profile

for the stanchion. It may sound more complicated but this method offers you significantly more control over where each filed groove will end up. You can slowly rotate the stanchion so you can keep the file from wondering off of your reference marks. This was the method used on the prototype to create the stanchions in the photo provided.

Stain each stanchion and glue them into position on the life rail. Glue the brass belaying pins into the holes and paint them. To finish it up the life rail can be glued down “firmly” to the deck. Keep in mind that there will eventually be a lot of rigging belayed to this rail which will no doubt place some stress on it. This would be a good time to ensure that the rail won't pull free from the model while you are in the process of rigging it. You might want to consider using some 28 gauge wire to peg the stanchions of the rail into pre-drilled holes on deck. Simply insert a small length of wire into a pre-drilled hole on the bottom of each stanchion and leave some of the wire showing so that portion can be inserted into the “properly placed” holes you drilled





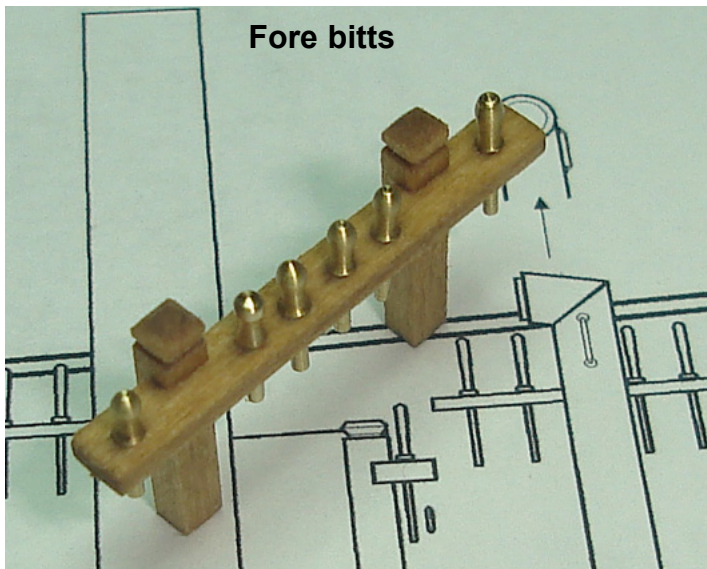

on deck. Be very, very careful to transfer the correct location of the fife rail from the plans to avoid drilling the holes in the wrong place. Once the fife rail is glued down it will be impossible to remove it without destroying it in the process.

#### Additional hatches and grating...

You can construct the coamings with gratings for the two hatches midship just like you did for those aft of the main mast. The only noticeable difference would be for the main hatch. Note how there are two separate gratings that fit into that coaming. The forward grate also has the front corners notched to allow the anchor cable to pass through them. You should drill a small hole as large as the notch into the deck beneath them. These are needed to push the ends of the anchor cables into them to simulate the cables traveling to the deck below. You can also paint the area surrounding these holes black to make it appear like there is a vast open space below the grating. Logically it would be easier to paint and drill these holes before you glue the grating into position.

#### Gallows bitts...

There are two gallows bits positioned alongside the coamings mid ship. These were a common fitting on brigs at the time. Spare yards and masts, the ship's boat, the oars for the sweep ports and any other materials would be stored on top of these. We will be lashing the ship's boat and oars on top of the gallows bitts later in the project. The two support posts for the bitts are made from 3/32" x 3/32" basswood strips. The tops were made using 1/8" x 1/8" stock. The shape for these can be copied from the inboard plan sheet. To avoid a blotchy appearance you can stain each piece before you glue them together.

Both gallows bits are identical except for the two chocks positioned on top of them. The ship's boat will sit securely in these.. The chocks will be custom shaped to fit the bow and stern of the ship's boat later and they shouldn't be added at this time. Other than this detail, care should be taken to construct a matching pair. Glue them into position on deck as shown on the plans.

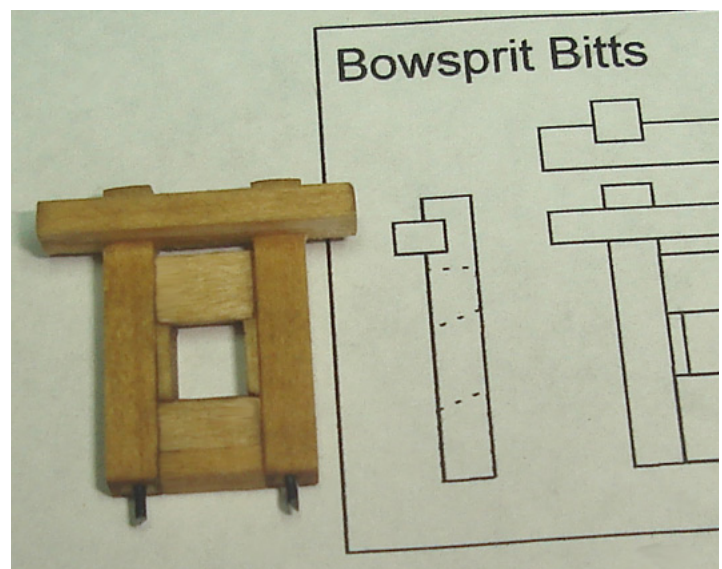

#### The riding bitts...

The riding bitts are located just aft of the fore mast. The anchor cable will wrap around its heavy beam before being run down those two square openings in the main hatch. The aft side of this heavy beam is rounded off. This timber is made using a 3/16" x 1/8" wood strip. Drill five holes along the center of the beam for the belaying pins. The two posts are made from 1/8" x 1/8" stock. File a groove around the tops of the posts with a needle file. Then chamfer the edges above the groove with some sandpaper which will finish it off and add a nice detail. The two posts need to be notched to accommodate the heavy beam. The notches can be made using a sharp #11 blade in your hobby knife. Then clean them up with a needle file. Two knees help support the riding bitts. The knees are 1/16" thick and glued to the forward edge of each post. Glue the riding bitts on deck but don't forget to create the raised pad of planking around the base of the fore mast first.

#### Fore bitts...

There is a small belaying rail in front of the fore mast. It is constructed very similar to the riding bitts. Only this time the posts are made from 3/32" x 3/32" stock. Notch each post to accommodate the 1/16" x 1/8" cross beam. The cross beam should be drilled for the belaying pins.

#### Galley stack...

The galley stack sits on top of a raised platform. The platform is 1/16" thick. It is made exactly like the platform the pumps sit on top of. The only difference of course being the size of the completed platform. The stack is made by cutting a 1/8" dia. Dowel to length. Two pieces are needed. You can see in the photo provided that the dowel needs to be cut at an angle where the two pieces are glued together. The end of the stack is drilled out so it looks like a hollow pipe. You don't have to drill very deep because it will be painted black afterwards and it will be difficult to tell just how deep it is at that point. You will notice there are two handles (one on each side) on the stack. These were used to rotate the galley stack so the smoke from the stove could be directed into the wind. Use 28 gauge black wire to form these. Glue them



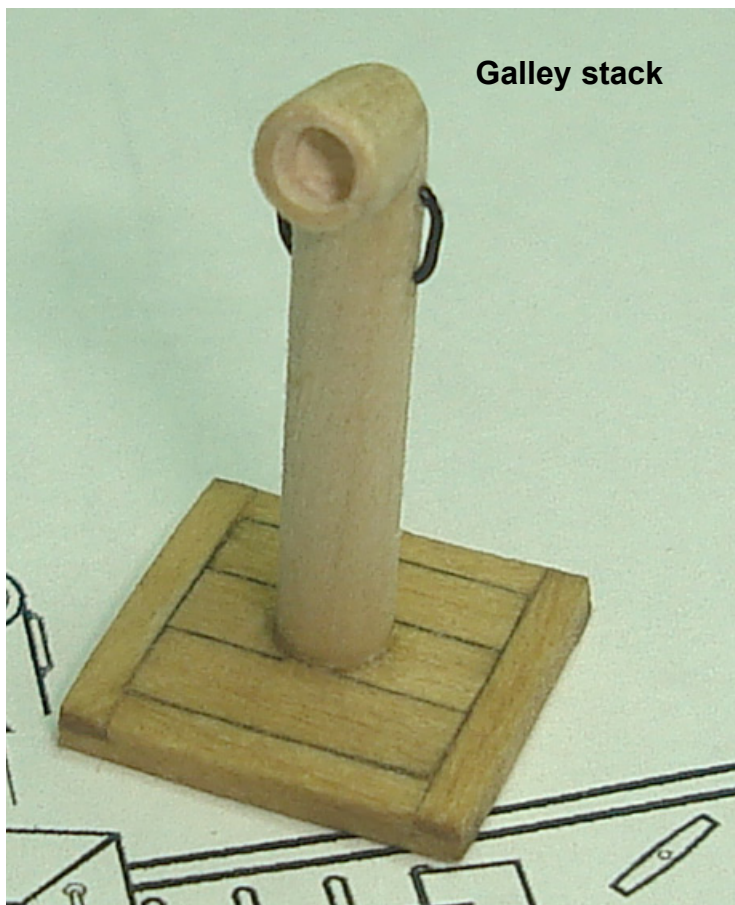

**Galley stack**

into pre-drilled holes. Paint the stack black before you glue it on top of the platform. This wasn't done on the prototype so it would be easier to see the handles in the photo provided.

**Bowsprit bitts...**

The bowsprit bitts are made just like the fore bits. The only difference is the fact that some packing pieces are fitted between the posts. 1/8" x 1/8" strips were used for the posts. The tops are left flat with no fancy grooved details. The cross piece is made using a 1/16" x 1/16" strip notched into the posts. Some scrap pieces of 1/8" stock was used to shape the packing pieces between the posts. Note on the plans how the top and bottom pieces are angled to accept the heel of the bowsprit. The square opening is tricky to establish at the correct angle but you should pay close attention to the plans while establishing it. Two additional filling pieces line the sides of the opening. Also note in the same photo how the bowsprit bitts are pinned into the deck. This will give it some extra strength when glued into the deck. It will be less likely to pull free if the rigging applies to much downward tension to the opposite side of the bowsprit.

**Eye bolts and split rings...**

The final task in this chapter will be to create the 22 eye bolts with split rings you see along both sides of the deck fittings. Check the plans for their locations. 28 gauge black wire was used to create them. You can see some of them in the final photos of this chapter. A small figure was added to the photos to show scale.





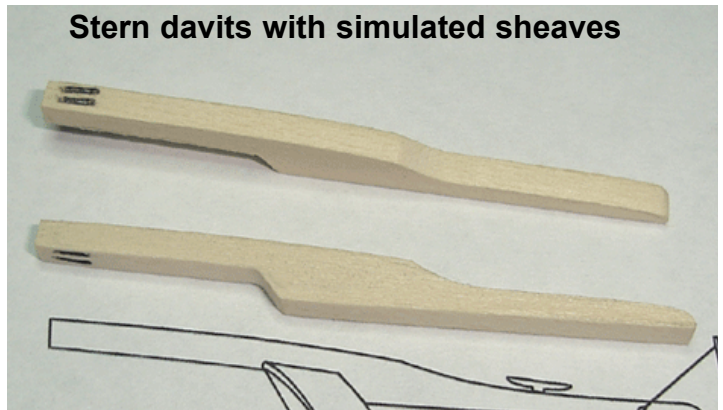

## Chapter Fourteen **The cap rail details**

**The timberheads** - Now is time to add those details to the top of the cap rail. You can see the timberheads in the photo above (left). There are five on each side of the hull. The first is slightly taller than the others. This is the timberhead that butts up against the cathead. All of the timberheads are made using a strip of basswood 3/32" x 1/8". Shape the tops just like you did for the posts on the five rail. They are shaped slightly different but the methods for making them are the same. You can use the plans as a guide for their shape and length.

Start by making a stop cut all around the diameter of the timberhead. Use a sharp #11 blade in your hobby knife to score this 1/64" deep cut around the top of the basswood strip. Then slice down toward this stop cut at an angle which will create the desired shape. To finish it up simply sand a chamfered edge all around the extreme top edge of the timberhead. It is easier to shape the end of the timberhead on a long basswood strip that you can hold comfortably in your hands. When it has been shaped to your liking just cut it free from the strip. Use the plans as a guide to find the correct length. You will notice that the bottom of each timberhead should be cut at an angle so it rests on top of the cap rail vertically. If the bottom is not angled properly the timberhead will look like its leaning over rather than being an extension of the ships frames. They should be perfectly vertical. They will be centered along the cap rail. The 1/8" wide side of the timberhead should face outward. Paint them black when you are finished.

**The stern davits** — The davits at the stern are laser cut from a 1/8" thick sheet of basswood. After sanding them a little bit you should simulate two sheaves on the outboard end of each davit. You can make them just like you did on the catheads earlier in the project. See the photo provided. Test fit the catheads in position at the stern. You will quickly see that the transom prevents you from being able to rest them atop the cap rail. You will need to either notch the transom to accommodate the davits OR notch the davits on an angle so they fit properly over the transom. Either way would be good, but you should choose the method you are most at ease with. You can see in the other photo provided that the transom was notched on the model prototype. A sharp #11 blade was used. Once again make a stop cut along the top of the transom where

the inside edge of the davit will fall. Don't go too deep. Even though this stop cut will need to be about 1/8" deep you should cut it a little at a time. Use the davit as a guide to draw a reference line on the transom so you cut the notch at the proper angle. The davit should be centered on top of the cap rail.

Once you have your first stop cut along the top of the transom, you can cross cut towards that stop cut. The stop cut will prevent you from over shooting your reference line. The first sliver of transom should pop free after cross slicing a sliver towards the stop cut. Proceed in this manner only removing a small sliver or shaving with each cross cut. You will need to make your stop cut deeper from time to time but remember not to go too deep. This process should go slowly and cautiously. You don't have to remove very much so take your time. Before you realize it the notch will be level with the top of the cap rail. Glue the davits into position and fill any gaps between them and the transom with some wood filler. Paint the davits black as shown. To finish them up glue a 5mm cleat on top of each stern davit as shown on the plans.



**Transom notched out to receive the davits**



**Stern davits in place, The cleats have not been glued into position yet.**



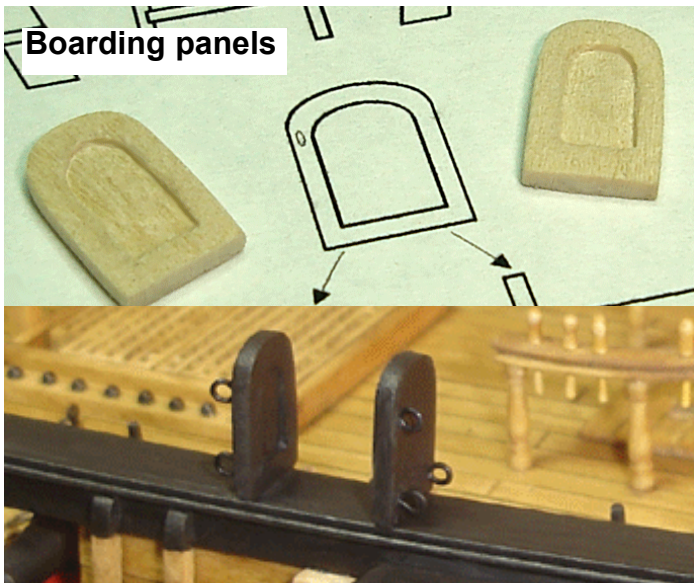

**Boarding Panels** — The boarding panels are the two supports that form the opening between the hammock netting along the cap rail at mid ship. They are positioned above the ladder inboard. These boarding panels were laser cut for you. You can use them as is but thin them down a little bit OR you could carve them on one side to give them a raised panel/molding edge. You should give it a try. The worse that could happen is you won't like them. If that should happen just throw them away and make some new ones. Its an easy shape to cut from a wood sheet.

Trace the profile of the molding around the boarding panel and score it with a sharp blade on this line. This will be your stop cut. Then slice back towards this stop cut with a micro chisel/flat blade. Three eye bolts should be glued into pre-drilled holes on one side of the boarding panel. You will seize the rigging line for the hammock netting to these eye bolts. Paint them black when you are finished and glue them on top of the cap rail when you're done. Be careful to position the port and starboard sides in the same location opposite one another.

**Hammock Cranes** — Paint the photo etched hammock cranes black before you remove them. Cut them free leaving the bottom about an 1/8" long which will be inserted into a pre-drilled hole on top of the cap rail. Position the

hammock cranes along the cap rail as shown on the plans. There are ten on each side of the hull. The rings on the outside edge of the hammock cranes are positioned so they face outboard. They will bend easily so be careful not to damage them. When they are all in position you can cut a 1/32" x 1/16" basswood strip to length. This strip should be glued into the slot of each hammock crane along the inboard side. The end of the strip should butt up against the side of the boarding panel. See the photos provided. The other end of the strip should extend 1/4" beyond the last hammock crane. Then run a length of .012 black rigging line through the rings on the outboard arms of each hammock crane. One end of the line should be seized to the eye bolt on each of the boarding panels. The other end is seized to another eye bolt. Insert that eye bolt into a pre-drilled hole in the cap rail adjacent to the last hammock crane. Be careful to apply just the right amount of tension so you don't pull the boarding panel off of the cap rail. It should be tensioned only enough so the line is not loose and sagging between any of the hammock cranes.

**The hammock netting** — The next step would be to lash the netting to the hammock cranes. This is a finicky process so take you time. Start off by cutting a strip of netting about 2 Ω" wide as long as you will need it. Bend it in half along its length. Gently insert it into the hammock cranes. You can use the eraser-end of a pencil to push it down into position. Make sure the pattern of the netting is running evenly across the cap rail and not twisted. When you are satisfied with its placement lash the ends of the netting to the last hammock crane. Tie it off with some black sewing thread. Tie it off on each of the arms on that last hammock crane. Then lash the other end to the eye bolts on the base of the boarding panels. Don't stretch the netting because it will distort its shape. Make sure the strip of netting is the correct length so you won't have to stretch it.

The netting should be somewhat secured now. Place a scrap piece of cardboard into the hammock crane so you can see the top edges more clearly. Trust me on this one. It will make your eyes bug out after a while if you don't. The cardboard makes it easier to focus on the top edge of the netting since it blocks out all of the deck fittings and distractions that can be seen through the other side. Start by carefully trimming the netting to the top of the rigging

*Hammock cranes are glued into position with the .012 black rigging line and 1/32" x 1/16" wood strip.*

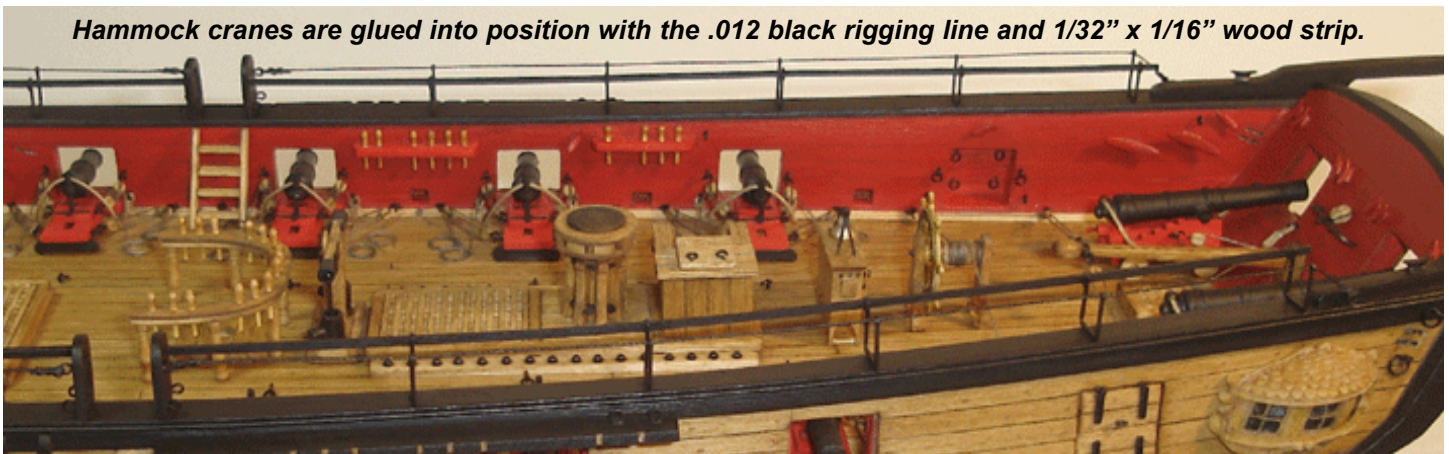



*Trimming and securing the netting into place with small knots. Apply a drop of CA to each knot afterwards.*

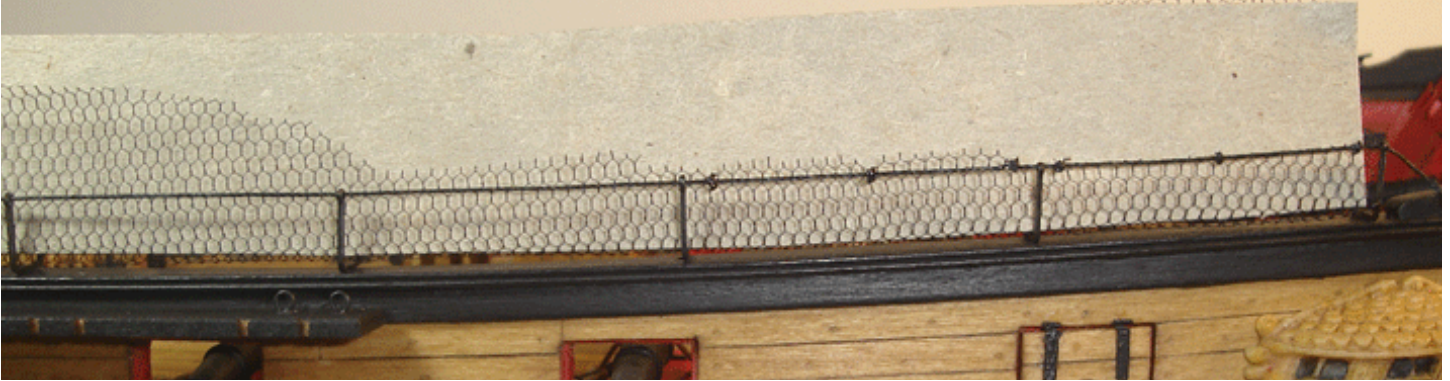

line you ran through the cranes. Be very very careful not to cut through that line. Use a small pair of scissors. They sell some very tiny hobby scissors which cut flush to any surface. Model Expo sells a few that are very suitable (SCI105, NS450, SC1338).

Only trim between one or two hammock cranes at a time. Then lash the netting to the rigging line in three places between each pair of cranes. Apply a tiny drop of CA glue to each knot and trim off the excess. When you're finished securing the outside of the netting you can turn the model around and do the same thing on the inboard side. This time trim the netting down to the top of the wood strip and then lash the netting to the strip between each pair of hammock cranes. When you are all done touch up the knots and hammock cranes with some black paint. The CA will leave some shiny spots on the rigging which is not desirable so paint over them to conceal it.

**Rudder Pendants** — To complete this chapter the rudder pendants can be added to the model. The pendants helped to secure the rudder if it lifted free from the ship during rough weather. It was also used to steer the ship in the unfortunate event that the tiller was shot away during battle. The rudder pendant is made by seizing some .018 rigging line to the end of a blackened chain. The chain can be cut to length as well by first attaching the last link to the eye bolts on the rudder. Let the chain hang free so you can see how it drapes. It shouldn't have too much of a drape to it or be too taut. When you are satisfied with how it looks cut the chain as desired. Then seize the rigging line to the end of the chain. The loose end of the line is taken up over the stern davits and is belayed to a cleat on the inboard side of the transom. Check the belaying plans for details. Finish it off by placing a rope coil on the cleat. See the photo provided.

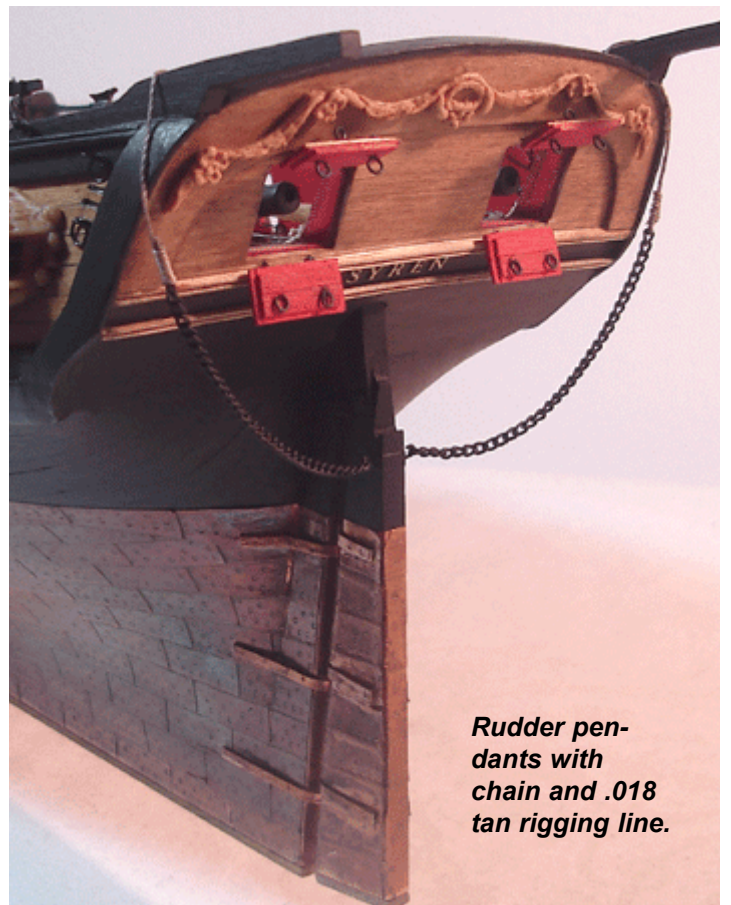

*Rudder pendants with chain and .018 tan rigging line.*



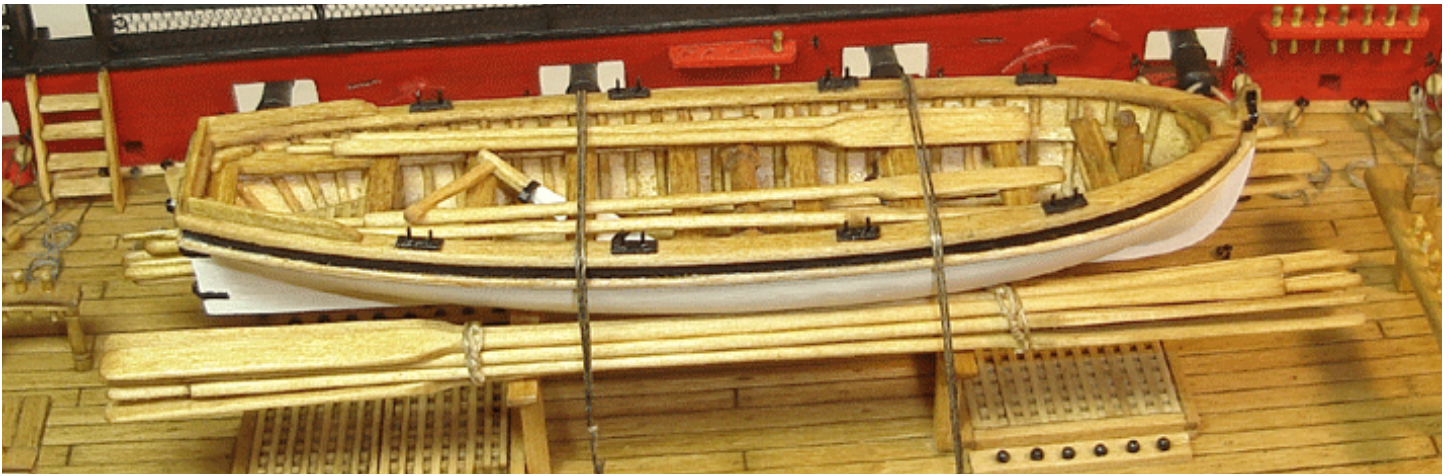

## Chapter Fifteen **The 25 foot longboat**

The brig Syren carried three boats for its crew. As to the sizes of these boats it isn't known. We do have a good sense of what she probably carried based on the detailed inventory of a similar ship built at that time. The brig Argus was built at the same time for the same purpose. She carried three boats including a 25 foot longboat with windlass, a 24 foot Pinnacle and an 18 foot jolly boat which hung from the stern davits. Our little model was designed to show only the 25 foot longboat. It will be secured atop the gallows bitts along with the sweeps.

To begin building the longboat many different construction methods could be used. The lift method is one of them. It is a very effective way to build a ship's boat for any model and many details can be added after the hull is shaped. The longboat will be a major focal point of this model and care should be taken while building it. Try and treat this little boat as if it were a separate modeling project all together. A poorly crafted longboat would only serve to ruin the appearance of an otherwise well constructed model.

Five lifts are laser cut for you. All are 1/8" thick. There are tabs on both ends of each lift. The tabs at the stern are slightly wider than those at the bow to help you position them properly. Glue all five lifts together making sure to precisely line up each and every tab. (see the photo below) After the glue dries you can cut the tabs free of the assembly and begin shaping it. The photo on the top of the next page shows the exterior of the hull after it has been sanded to shape. Don't thin down the walls of the hull too thin at this point. Simply sand the bottom edge of each lift to get a smooth continuous hull. When you are satisfied, establish the sheer of the long boat by sanding a graceful curve into the uppermost lift. Refer to the plans which show how the sheer dips toward

mid ship. That same photo shows the approximated sheer with a heavy black line before it was created. Another photo also shows the long boat resting in position on top of the gallows bitts to give you a sense of the scale in comparison to the Syren's deck.

With the exterior completed you can begin to thin down the boat's hull from the inside. Try and make the shell as thin as possible. 1/32" thick would be best but no thicker than 1/16". This is not the easiest task to accomplish by hand. Some of you might find it helpful to use a small sanding drum on an electric rotary tool. Be very, very careful if using a rotary tool. Apply the lightest of pressure. The basswood is soft and such a powerful tool can quickly remove too much material. Finish it up by sanding it by hand with some fine sandpaper. Use some wood filler to fill any gaps, cracks or areas that were thinned down too much. Paint the outside of the hull white and if necessary paint the interior to look like wood.

To start constructing the boats skeleton glue a 1/32" x 1/32" strip of wood down the center of the boat as shown. Soak the strip first to make it pliable enough to bend up the bow. Then using the same strips start gluing the individual frames on both sides of this "keel". It will be easier to use a long strip that has been soaking for a while. Once a frame is glued into position you can snip off the excess. Space the frames about 3/32" apart from one another. Sand them smooth when they are all completed but make sure every frame is 100% dry first. If you attempt to sand them while wet the wood will shred and tear rather than become smooth.

**Lifts glued together with the tabs aligned. The Syren's longboat has five lifts.**





Establishing the correct sheer profile for the longboat as shown by the black line below.



**Typical method for building a ship's boat with lifts.**

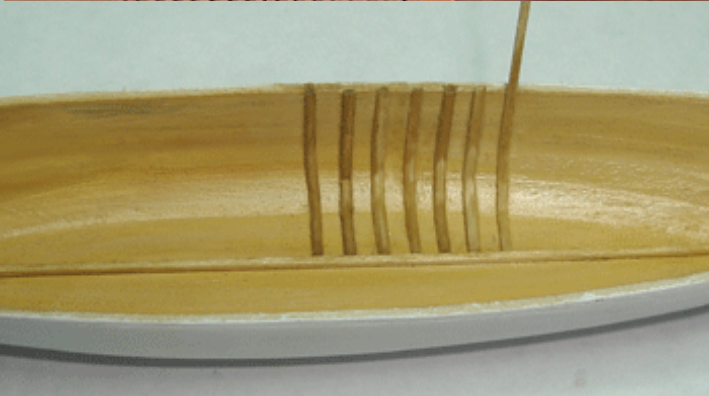
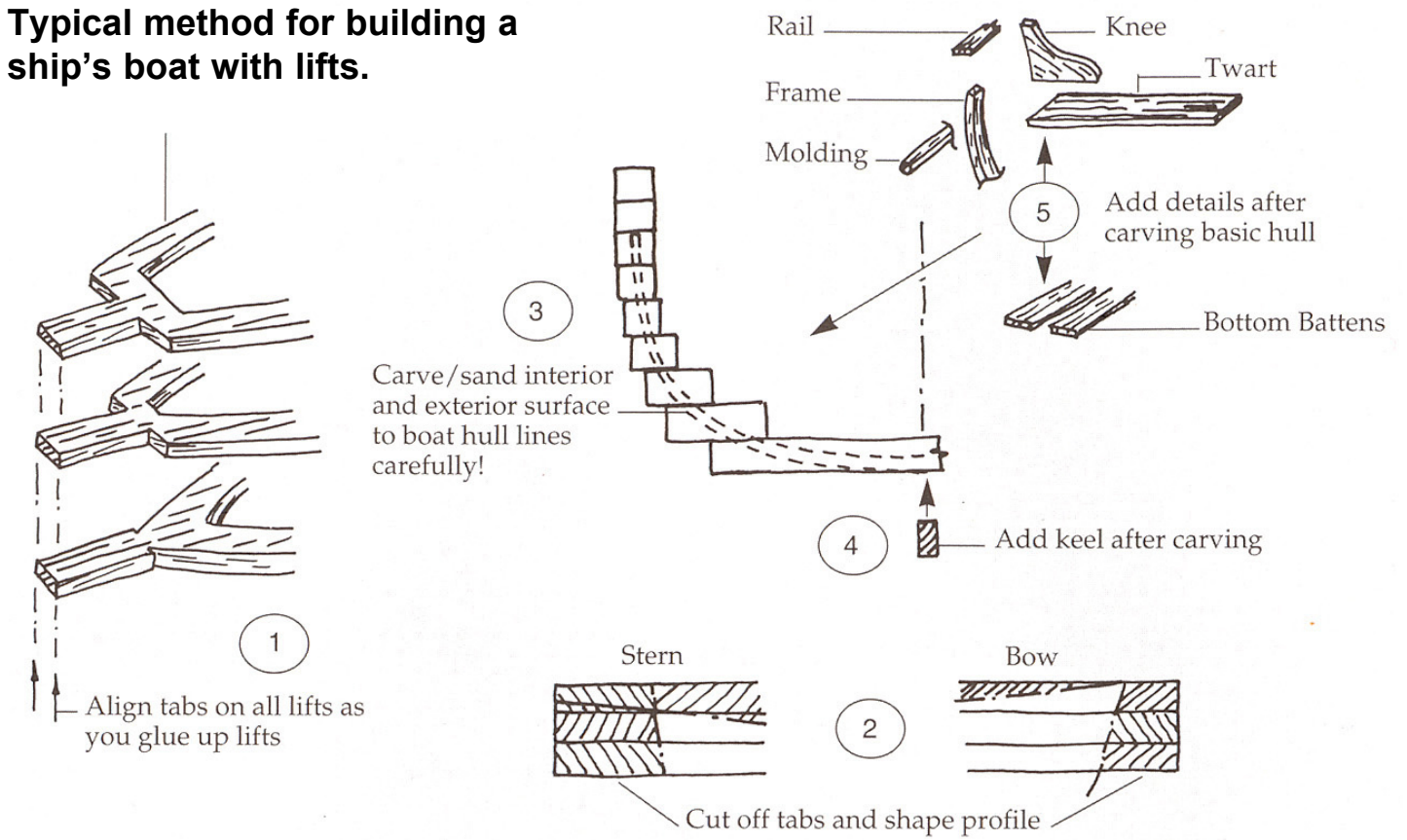



The photo to the right shows the floor boards in place. Seven 1/32" x 1/16" strips are shaped and glued onto the frames. The first plank is placed directly down the center of the boat on top of the "keel"

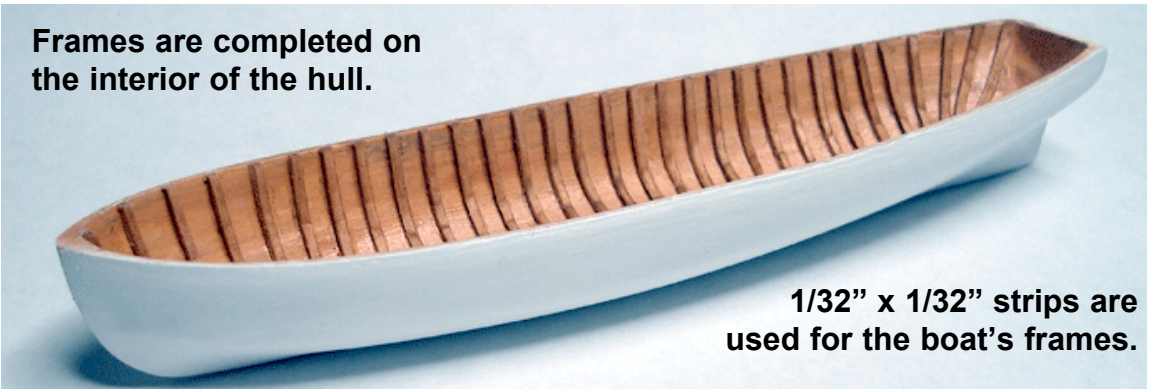

**Frames are completed on the interior of the hull.**

**1/32" x 1/32" strips are used for the boat's frames.**

Now it is time to construct the two gratings that are shown in the photo below. They are positioned at the bow and stern respectively. The same grating strips that were used for the deck hatches will be utilized for this purpose. They will however be modified first. Instead of assembling them "egg-crate" style, they will

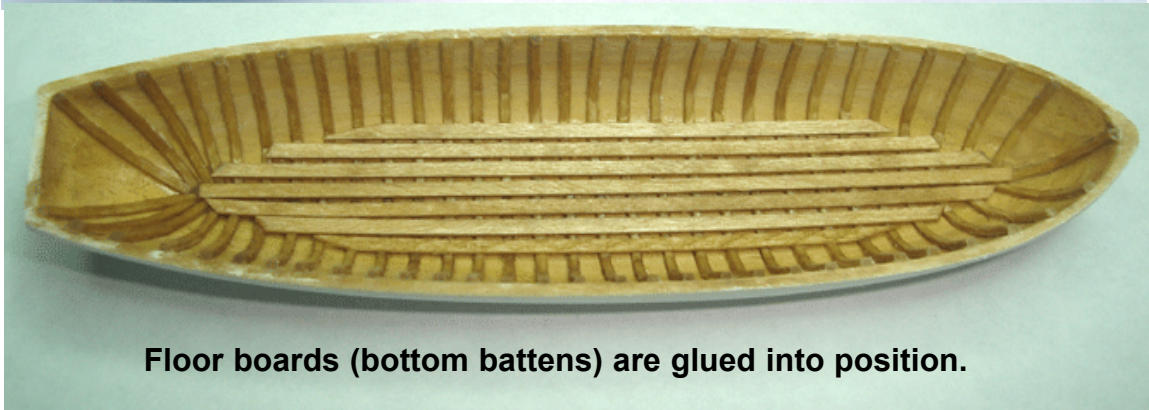

**Floor boards (bottom battens) are glued into position.**

be glued together edge-to-edge. This will give you the appropriate thickness. Even after this is done the holes in the grating would be too large and the strips should be cut down before gluing them up. Take a sharp blade and steel-edged ruler and cut the strips thinner on both sides. Look at that same photo which shows a strip before being modified and after. You can see that the strip on the right is considerably thinner. After gluing them together edge-wise the general shape of the finished grate can be made. That shape should be smaller than you will actually need so a 1/32" x 1/32" strip can be framed around the entire grate to finish it off. It is time consuming to build the grates but they will add a great deal of detail to your finished longboat. Stain the grates before gluing them into the boat's hull. Refer to the longboat plan for the correct position and orientation for each grate.

One length of 1/32" x 1/16" basswood strip is glued down each side of the hull for the thwart supports. The strip is placed about 1/8" below the top edge of the hull. Keep this distance consistent. The thwarts will be placed on top of this support strip. Be sure the distance from the top edge

is also consistent on both sides of the hull so the thwarts sit level on top of them.

The thwarts are made from 1/8" x 1/32" strips. This is not a difficult procedure but try and space them evenly apart as shown on the plans. You can see that a little more space was left between the thwarts where the windlass will eventually be placed. Note the construction of the thwart that has the iron bracket used to secure the mast. It was built up with another wood strip and 22 gauge wire was used to simulate the iron bracket. Stain all of these wood pieces before you install them. Once again this will ensure that the finish won't become blotchy on account of any excess glue seepage.

The windlass will be made from a length of 3/32" x 3/32" stock. It needs to be carved to shape. This is not a terribly difficult task. If you examine the photo on the next page you will see that some reference lines were marked on all four sides. These lines define the part of windlass where the bar would be inserted into some holes to

**Modify the grating strips and glue them together edge-wise.**

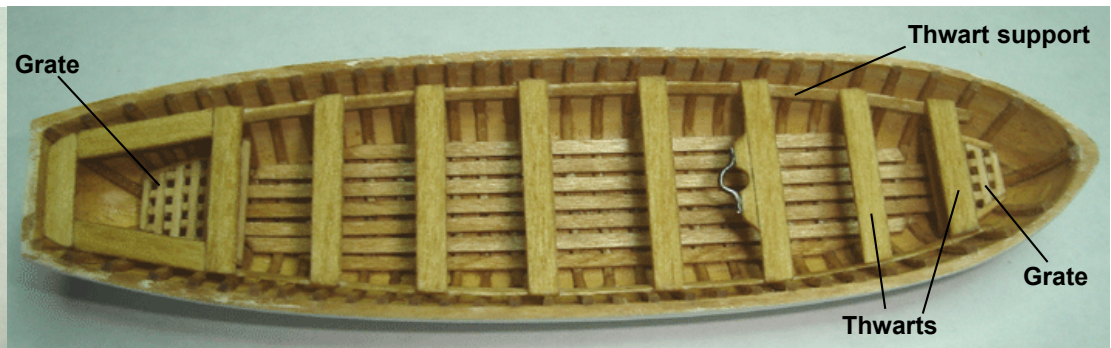
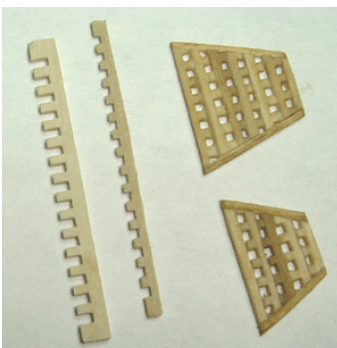



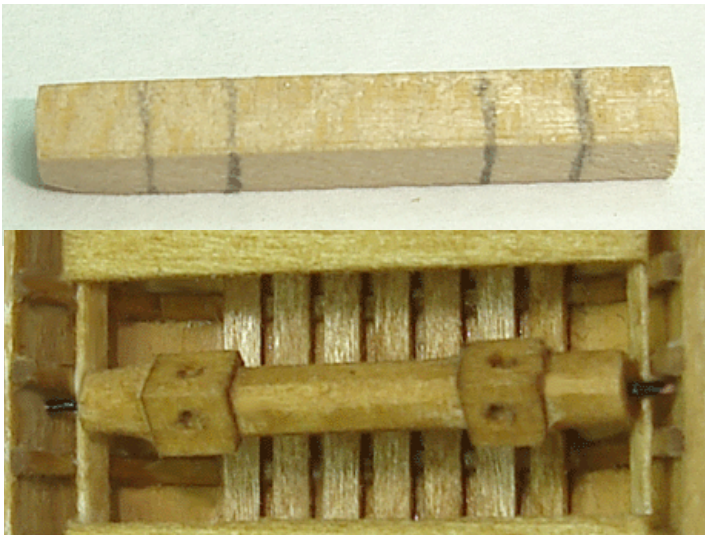

operate it. These segments of the windlass will not be carved. The areas between them and alongside them will be. These areas need to be shaped so they are thinner and eight-sided as opposed to four-sided. To do this, use a sharp #11 blade to score stop cuts on all of your reference lines. They don't have to be very deep. Then use your blade to slice toward each stop cut. Do this all the way around the windlass to define the two square blocks for the windlass bars. Then use some sandpaper or a file to completely thin down the areas around them being conscious of the fact that you are reshaping them to have eight sides. Drill some tiny holes on each side of the square blocks when you are finished.

Tiny lengths of 28 gauge wire should be inserted into both ends of the windlass. The windlass will sit on top of the thwart support strip. The wires/pins will keep the windlass from falling. You can see the wires on each end in the photo above. Note how the windlass is held loosely in position. To secure it firmly, small pieces of  $1/32'' \times 1/16''$  strips are cut to length. They need to be roughly  $5/32''$  long. A small notch is filed on the bottom edge of these pieces. They are slipped over the wires on either side of the windlass and glued to the boat's frames. Once this is done the windlass will be secured. Stain all of these elements before hand.

You can now turn your attention to finishing the exterior of the boat. First you must cut the cap rail from a  $1/32''$  thick sheet of basswood. Simply press the boat firmly against

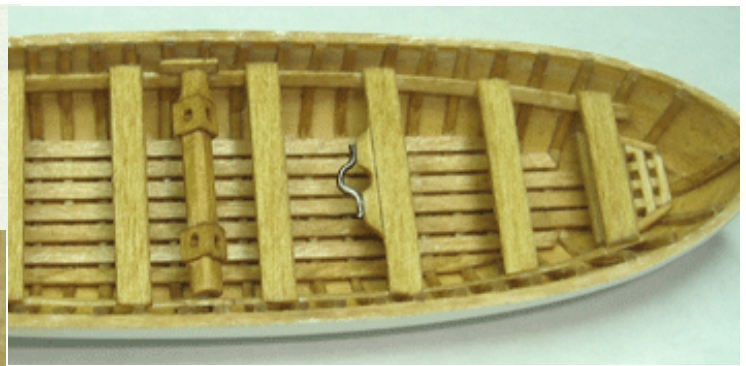

the sheet and trace its outside profile onto the sheet. The cap rail should overhang the sides of the hull a little. So when you start to cut it out of the sheet make sure you do so well outside the line you traced. The rail can be sanded to its final shape after it is glued on the boat. But before you cut it out, make another line about  $1/8''$  inside the first one. This will establish the width of your cap rail. Ultimately you want the cap rail to be about  $3/32''$  wide. It should not be wider than that. This would be  $6''$  wide on the actual longboat. Cut the cap rail free of the sheet and glue it into position. Less than  $3/32''$  would actually be more realistic. Once in place you can sand it to the proper width inboard and outboard. Leave a little overhang inboard and outboard as well. The photo below shows the cap rail completed.

The keel, stem and stern post were laser cut from a  $1/16''$  thick sheet. These are shown in that same photo. The stem was glued into position first followed by the keel and stern post. Refer to the plan for the proper templates. A  $1/32'' \times 1/32''$  strip was glued below the cap rail as a molding. It was stained before hand. Then the area between the cap rail and the molding can be painted black. Sand and repaint the bottom of the hull, the stem, keel and stern post. There are just a few more details to add and the longboat will be finished.

The photos show the oarlocks, gudgeons, and bowsprit strap and step completed. There are tiny knees on the sides of each thwart visible as well. These are the final details you will need to add to your longboat.

The bowsprit step is shaped using a  $3/32'' \times 3/32''$  strip of basswood. Notch the top of the strips as shown on the plans. Then glue it into position "just" starboard of the

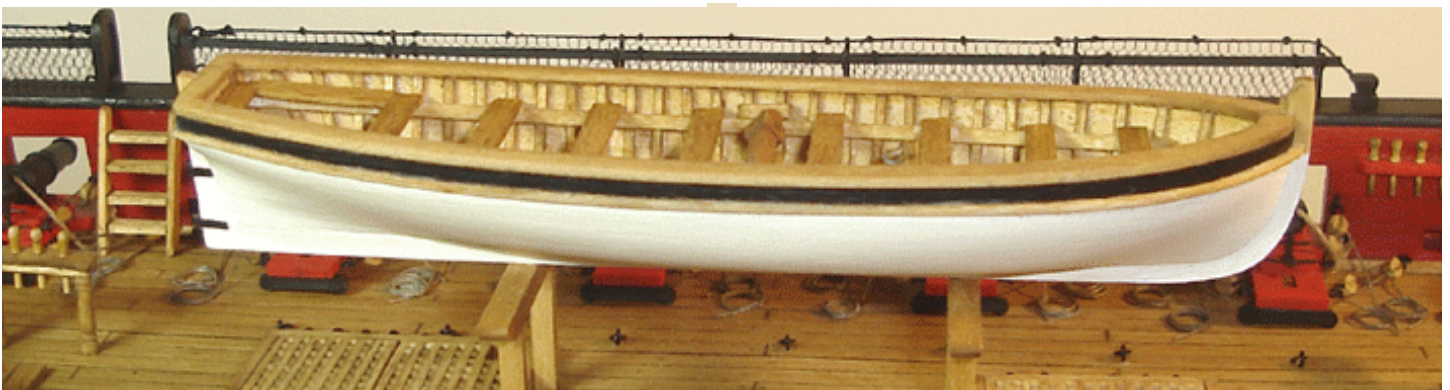



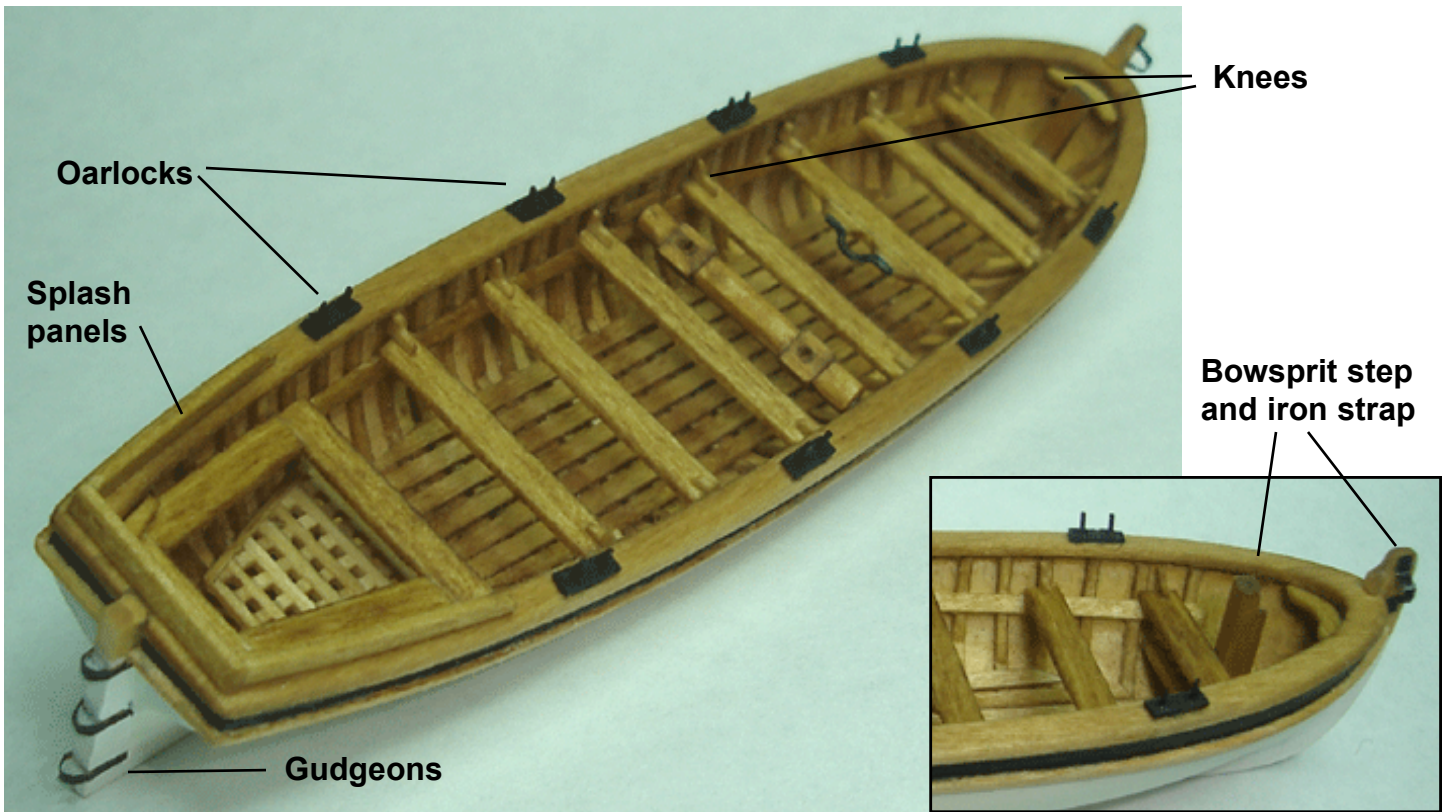

stem. It will sit on top of the grate at the bow. In actuality it would have passed through the grate and would have been secured to the bottom of the boat. But for our model, resting it on top will be just fine. A small iron strap was fashioned from a scrap piece of copper tape. The tape was first cut to 1/32" wide. It was glued directly to the starboard side of the stem as shown to simulate the bowsprit strap. The bowsprit step is positioned in line with this strap. The strap should be painted black.

The gudgeons for the rudder hinges were made the same way as the bowsprit strap. Strips of copper tape were used. They were painted black and glued onto the stern post. They are glued at a right angle to the stern post. As you can see from the plans there are three of them. You will notice that there are some splash guards at the stern that surround the cockpit of the longboat. These three panels are made from 1/32" x 1/16" strips. They are glued on edge in the center of the cap rail. You can take their shape from the plans.

There are eight oarlocks glued on top of the cap rail. These can be made in two steps. The first step is to cut a 1/32" x 1/16" strip into small same-sized segments. They are all painted black and glued into position. For step two, drill two tiny holes on each side of those black

pieces. Then insert some 28 gauge wire into those holes. Cut them to length and insert them while being careful to align them straight and evenly. Touch them up with some black paint after trimming them so they are all the same height. You wouldn't be able to insert them into those tiny segments before mounting them because the wood most certainly would split.

Lastly there are several tiny knees shown on the plans that are placed on the ends of each thwart. Shape these from 1/32" x 1/16" strips and glue them onto the long boat. A few additional knees are seen at the stern and the bow. Touch up any paint or stain problems when you are finished. This completes the longboat, but you still need to make eight sweeps, four oars and the rudder. The sweeps and oars are relatively simple to make. Templates for them are supplied on the plans. Cut some 1/8" x 1/16" strips to length. Trace the shape of the oars and sweeps onto the strips. The blades should be thinned down considerably after rough cutting them from the strips. Use some sand paper to round the shafts. To complete them, mark the end of the shaft to establish the length of the handles. Create a stop cut around the shaft on this reference line. Then shave very thin slices from the shaft to shape the handle. Use a sharp blade in your hobby knife and slice towards your stop cut. These handles will

### Shaping the sweeps and boat's oars from 1/16" x 1/8" basswood strips.

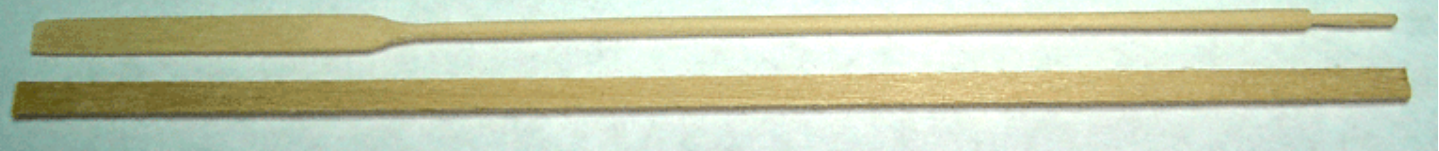



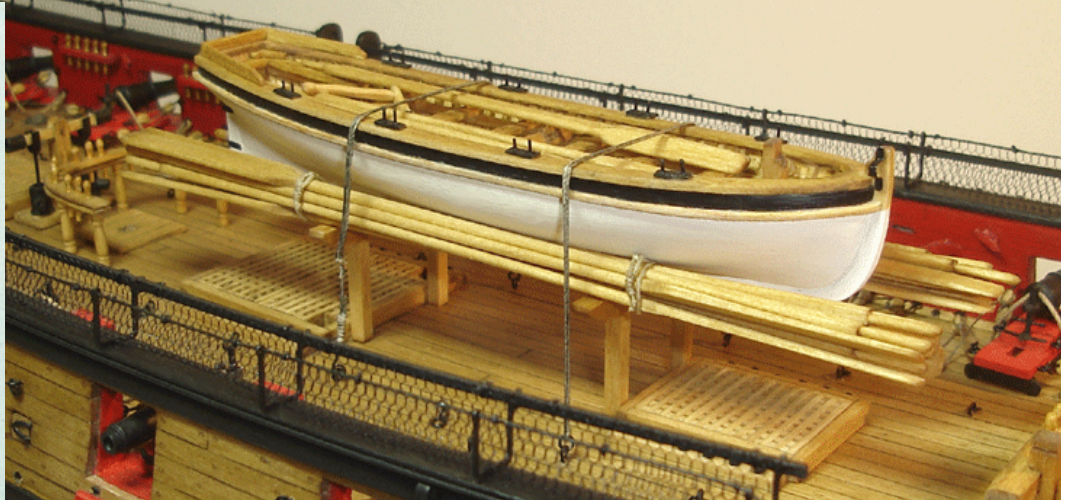

be very thin and fragile so take your time and be careful. Stain them when finished.

The rudder is laser cut for you. Paint it white except for the rudder head. Then use some copper tape cut to the appropriate width to form the pintles. The pintles are painted black. Glue tiny pieces of 28 gauge wire into the pintles to simulate the pins. This should be done after the pintles are glued to the rudder. The tiller is shaped using a 1/16" x 1/16" strip. It will need to be sanded even thinner as 1/16" is too heavy. The tiller can be gradually tapered towards its end and left a little thicker where it will be glued to the rudder head. You could get fancy and carve a small ball on the end of the tiller much like the larger tiller on the Syren. Attach it to the rudder head with a pin like the larger tiller was as well. Stain the unpainted areas and place the finished rudder in the longboat. It was usually stored this way and was not positioned on the stern post until it was needed. The photos above show the smaller oars and rudder stowed in the longboat. You could add many other common tools, rope coils and water casks in the boat as well. The amount of detail you want to add is up to you.

With these details completed the boat can be glued on top of the gallows bitts. It won't be very secure but the glue will hold it in position. There are chocks shown on the plans but these are optional. The chocks were used to secure the longboat more securely. But it won't be neces-

sary on our model. The sweeps will be lashed together in two bundles of eight. See the photos above. Use some .018 tan rigging line to lash the bundles of sweeps together.

When these bundles are glued on both sides of the longboat it will serve the same purpose as the chocks and make them unnecessary. They would also not be seen behind the sweeps either so the choice to make them is up to you.

The longboat and sweeps are lashed down tightly on those gallows bitts. Use some .018 Tan rigging line to do so. Create two hooks out of 28 gauge black wire. Seize them onto one end of the rigging line. Place the hook through one of the rings on deck adjacent to the gallows bitts. Take the loose end of the lashing over the longboat through the corresponding ring on the other side. Then bring it back over the top and seize the loose end to the original "pass" of the lashing with some sewing thread. Seize it just above the hook. You can see how this was accomplished in the photos on the previous page and at the beginning of this chapter.

At this point in the project the hull is essentially completed. The next phase in construction will consist of making the masts and spars. Shortly after, the rigging can commence which will complete the model.

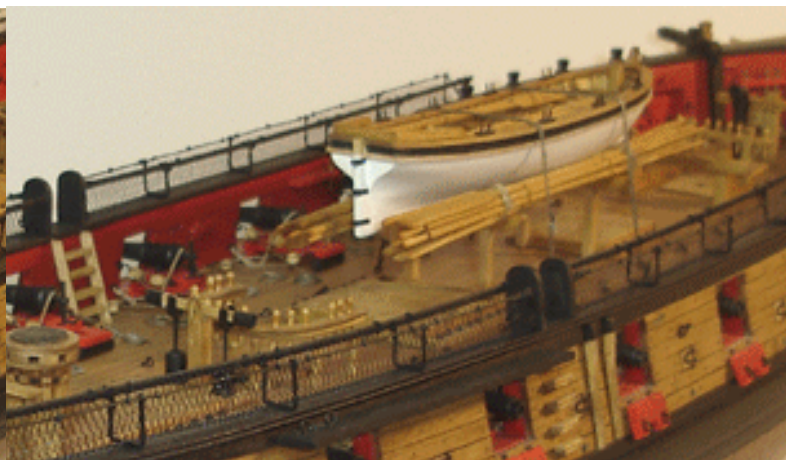
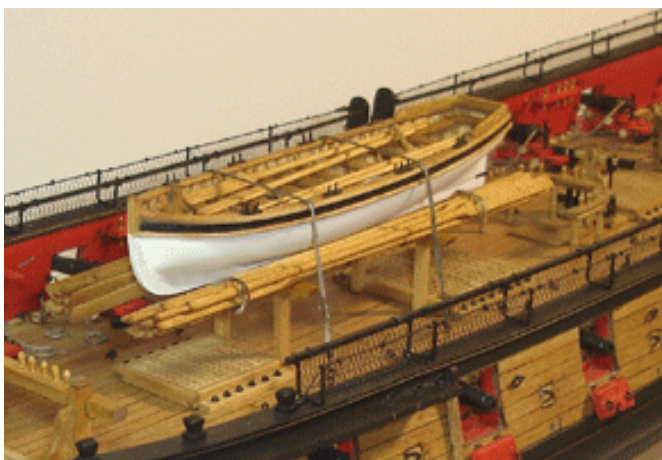





## Chapter Sixteen Bowsprit, Jibboom and Flying Jibboom

**The Bowsprit** - is made using a 1/4" dia. dowel. See the photo above. The Bowsprit (as for all of the masts and spars) should be tapered. An easy way to do this would be to place the dowel in a power drill and taper it to shape with some medium sandpaper as it turns. Note in the photo and on the plans that there is a square tenon at the heel of the bowsprit. Use a sharp #11 blade to carve this tenon. Keep in mind the angle and size of the tenon shown on the plans. The tenon must fit easily into the opening you made for it in the bowsprit bits. Check it periodically while shaping it to avoid removing too much material.

The outboard end of the bowsprit gradually changes shape. You must form a square profile and tenon as shown on the plans. The pieces that form the bees will not fit properly unless they are glued against a flat squared edge. The bees consist of two main elements, the seating and the bee blocks. The seating "sits" on top of the blocks. The blocks are made from a length of 3/32" x 1/16" wood. You must notch the wood using the plans as a guide to find their exact positions. Use a sharp blade and some files to make them. Then create two appropriately sized sheaves to fill the slots. These will not be working sheaves but make sure you allow enough room on either side for some rigging to pass through them. Make the sheaves from any suitable scrap wood and sand them flush with the inside edge of the bee blocks. Note how there is only one sheave for each block. Check the plans to be sure you are placing them in their correct slots.

The seat for the bees is made using a 1/8" x 1/32" strip. Notch them to line up with the notches you made in the bee blocks. Glue them onto the end of the bowsprit first followed by the bee blocks underneath them. To avoid a blotchy appearance you can stain all of these elements before assembly.

The saddle for the spritsail yard sling is also made of two elements. The first layer is made using some stiff card or a manila office folder. Cut the material to size and glue it onto the bowsprit after staining it. There is a thinner (1/32 x 1/16") strip of wood glued on top of the aft end of this first layer which will complete the saddle. Soak it well before attempting to bend it to fit the bowsprit. The jibboom rest has been laser cut for you and can be glued into position as well.

A fairlead is positioned under the Bowsprit. It has been laser cut for you but six holes will still need to be drilled through it. Take your time and don't apply too much pressure while drilling them. It is recommended that you actually drill the holes before you remove the fairlead from the 1/16" thick laser cut sheet. This piece is very fragile and could split if you aren't careful. Glue it into position when completed.

There are five gammon chocks which are made from 1/32" x 1/32" strip wood. Some folks prefer to cut them to length and glue them onto the bowsprit. Then they shape them with a sharp blade afterwards. Note how each chock slopes aft. It might be tricky to pre-shape such tiny pieces before they are glued firmly into place first. There is another chock/cleat on the bottom of the bowsprit (directly under the jibboom rest).

To complete the bowsprit, simply use the supplied 1/16" wide pinstripe tape to simulate the three iron bands inboard. Take their locations from the plans. Rather than install the completed bowsprit on the model now, it will be easier to complete the entire assembly first. This includes the jibboom, flying jibboom, jack staff and dolphin

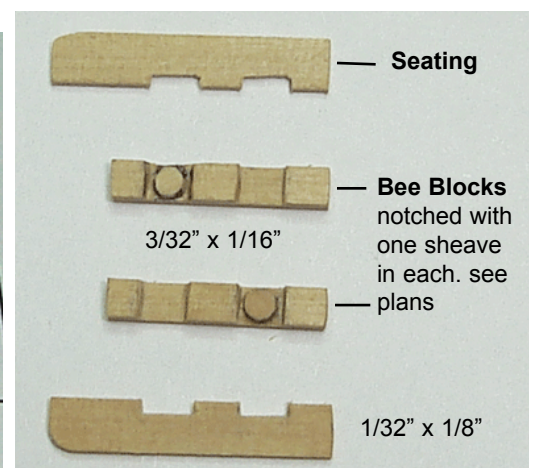
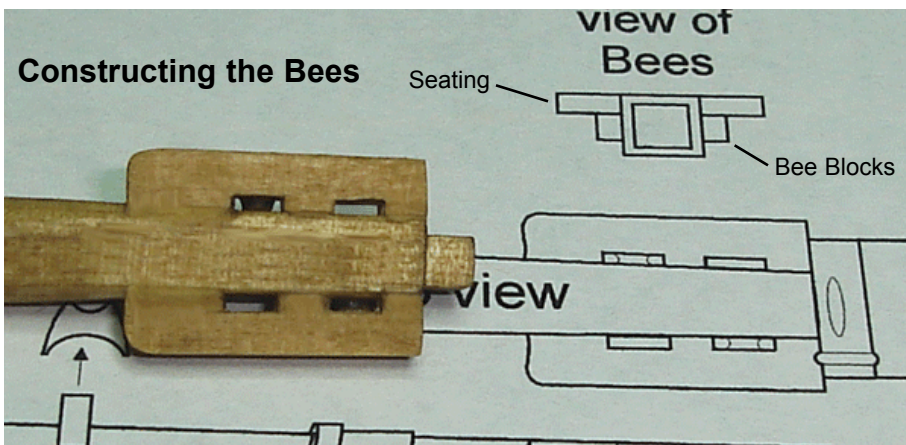



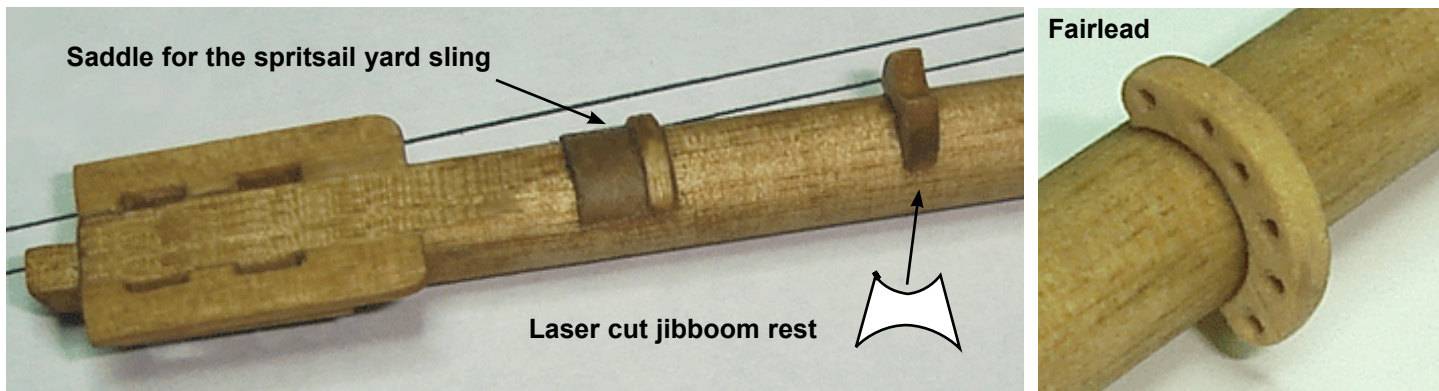

striker. Once painted and completed, you can also attach any blocks ahead of time because this is also easier to do while not installed on the model.

**The Bowsprit cap** - has been laser cut (1/8" thick) for you. It was cut slightly longer than needed because as you can see in the photos provided, you must sand the top and bottom of the cap to their correct angles. Note on the plans that while the cap is positioned vertically the top and bottom are angled to match the run of the bowsprit assembly when installed. Two holes are laser cut through the cap. One of them is square. These two holes need to be filed to that same angle. The square hole needs to fit the tenon you carved on the forward end of the bowsprit. Check the fit periodically as you shape the hole in the cap. There is a third smaller hole on the forward side of the cap (port side). This hole is made to accept the tenon on the heel of the flying jibboom. It should not be drilled all the way through the cap.

The jack staff is secured to the aft side of the cap. It will fit into a channel that you can file on the starboard side. You can see this channel in the photos provided and on the plans. The bees should also have a notch filed into it which will line up with the channel you made to accommodate the jack staff. Lastly, the cap has seven eye bolts inserted into pre-drilled holes. Check the plans for their locations and paint them black. Glue the cap onto bowsprit.

**The jibboom** — is made using a 5/32" diameter dowel. It should be tapered to fit through the bowsprit cap and sit comfortably on the jibboom rest. The heel of the jibboom is eight sided and should be shaped as shown on the plans. You will also notice a large sheave that you must create through the heel of the jibboom. The outboard end should be carved or filed to shape as well. See the photos provided on the next page. The tip of the jibboom has a groove

filed into it. This will be used to rig the fore topgallant stay. Then wrap some 1/16" wide black pinstripe tape around the tip of the jibboom. This iron band is positioned just behind the groove. It will simulate the first half of the jibboom iron shown on the plans. A corresponding band will be wrapped around the flying jibboom in line with this one. A photo etched brass strip will connect the two bands and secure the two together. But before you move ahead and construct the flying jibboom it would be a good idea to make the traveler for the jib stay. It would be difficult to slip onto the jibboom after the flying jibboom is glued into position.

**The traveler ring** - is made out of 28 gauge black wire. See the series of photos provided. The first photo shows the wire bent to shape. Simply crimp the wire to form the tighter bend at the top. Then bend the wire around an appropriate sized dowel to form the larger ring. Overlap the end of the wire as shown in the first photo. Then use a wire cutter to cut through the larger ring where the wire overlaps. This will ensure a precise seam where the two ends meet. Lastly, wrap some fine wire around the top of the traveler as shown in the second photo. This completes the fabrication of a simple traveler. Paint it black when you are finished. You can see it slipped onto the end of the jibboom in the photo provided. You will actually need two of these. A second smaller traveler ring will be needed for the flying jibboom. See the plans for details.

**The flying jibboom** — is tapered from a 1/8" diameter dowel. The heel is eight sided like the jibboom but at this scale it would be perfectly fine to leave it round. Create a small tenon in the heel of the flying jibboom. It will be inserted into the small hole you made in the cap for it. Check its fit periodically as you are shaping it. The outboard end is shaped much like the jibboom's. Create the groove on the tip and the sheave as shown. To position the iron band (1/16" pinstripe tape) simply hold the flying jibboom in place on the assembly. Then mark the location





**1/8" thick laser cut cap.** It has been cut longer than needed so you can sand the top and bottom to the correct angles. See the plans for details. The holes should be filed at the same angle. The smallest hole on the forward side will only be drilled part way through. Its for the heel of the flying jibboom.

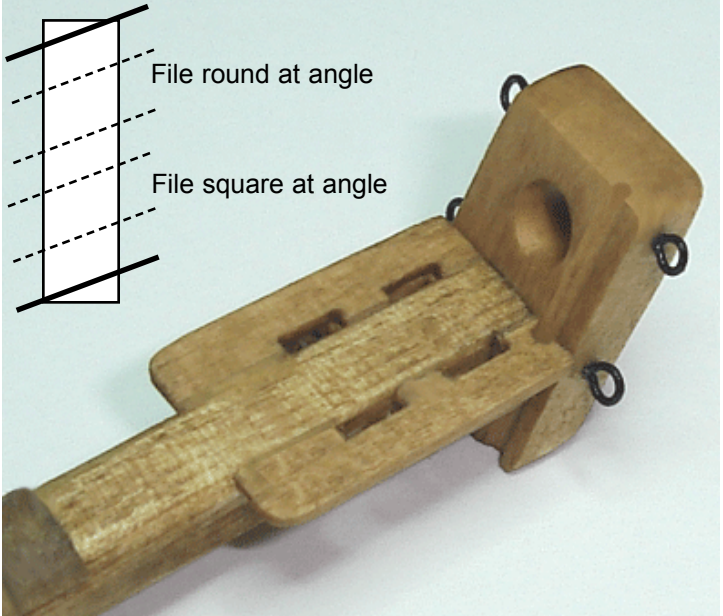

**Bowsprit Cap**

for it directly adjacent to the band on the jibboom. To connect the two bands, use the brass photo etched piece that completes the simulated jibboom iron. The photo etched piece has two pins on either end. These pins will be glued into pre-drilled holes through the pinstripe tape bands. Mark the locations for the holes to ensure the flying jibboom is positioned at the proper angle in relation to the jibboom. Then pre-punch through the pinstripe tape with a sharp awl or pin. This is very important. If you don't punch a starter hole through the tape it will certainly get caught up in the drill bit as you drill your holes. It will tear up the taped bands and you will need to redo them. Glue the photo etched piece into the band on the jibboom. Once it dries you can glue the flying jibboom into position. See the photos attached. Remember to have your traveler ring on the jibboom before you glue the flying jibboom into place. Paint the jibboom iron black when you are finished

At this point in the construction of the bowsprit assembly it would be a good time to attach the 3/32" single blocks to the cap as called for on the plans. You could also add the two 3/32" single blocks to the end of the flying jibboom for the outer martingale stays. This will be easier to do now before adding the dolphin striker and jack staff. You can also see in the photos that follow how the bowsprit and jibboom were painted. The cap and portions of the jibboom (including its heel) and bowsprit were painted black. The jibboom is also lashed to the bowsprit using .028 black rigging line as shown on the plans.

The jack staff is made using a 1/16" thick dowel. Taper it and add a ball truck/cap on the top. This can be made from a scrap piece of 1/16" thick planking. Sand or file the ball truck to its round shape and drill a small divot in the center of one side. Create the divot so it will fit on the

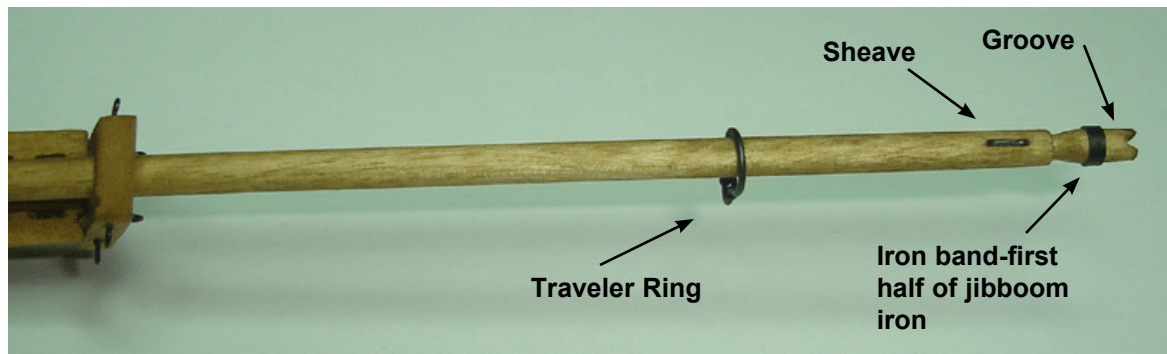
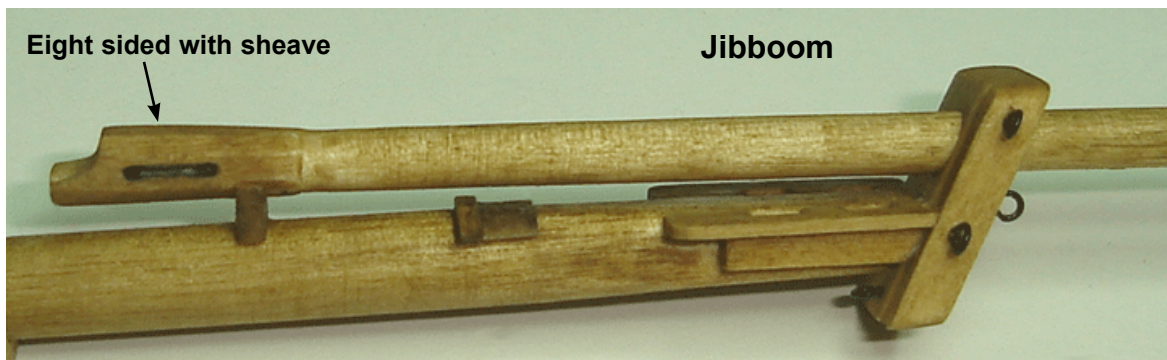



## Flying Jibboom

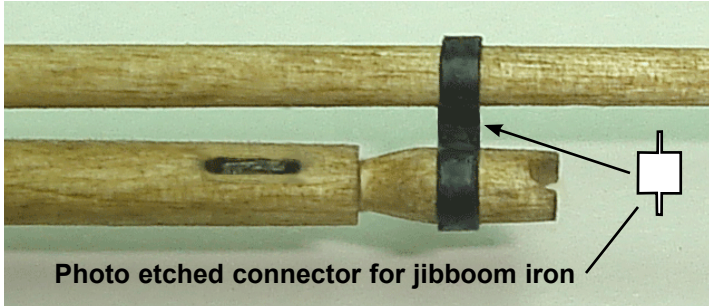

To finish it off cap the top of the assembly with length of 1/16" x 1/8" strip as shown in the photo provided. The dolphin striker will be painted black but was not done on the prototype until after it was mounted so you could see more details in the photos. Paint it before you glue it onto the fore side of the bowsprit cap. The dolphin striker is also attached to the cap with some simulated staples. One or two would work just fine. Use 28 gauge wire as you did earlier.

tip of the jack staff where you should glue it into position. Paint the ball truck black. The jack staff should slide into the groove you created on the aft side of the cap. Glue it into place and paint the part of the staff that overlaps with the cap black. The jack staff would have been secured to the cap with staples. You don't have to drill any holes into the cap for these. Instead just bend a small length of 28 gauge black wire to make the staples and glue them onto the jack staff. This will do a great job of simulating the actual staples if their ends just touch the face of the cap.

The Double dolphin striker is made primarily from 1/16" x 1/16" strips. Cut them to length and drill the three holes through them as shown on the plans. Create the small cleats for the bottom of each strip using 1/32" x 1/32" strips. These two pieces will be attached to a triangle piece of wood that is also 1/16" thick. This piece will create the proper angles for each side of the dolphin striker.

You can now create the bowsprit collars for the Bobstays, fore stays and bowsprit shrouds. The order that they appear on the model is very important. Be sure to examine the plans carefully. You should use .021 black rigging line to create them. There are four closed hearts (3/16") and two open hearts required for the collars. These are all laser cut for you but the grooves will need to be filed along their edges for the rigging line. Try to sand off all of the laser burn marks but be very careful as they are delicate. The hearts are only 1/16" thick and may split along the grain if you apply too much pressure on them. But don't worry since there are plenty of them laser cut if you need extras.

It is now time to glue the entire bowsprit assembly on the model permanently. To do this you must first file the slot in the bow so the bowsprit will sit nicely into it. Use a round file to create the shape the opening. The bowsprit should sit about half way into the rounded notch. It will need to be

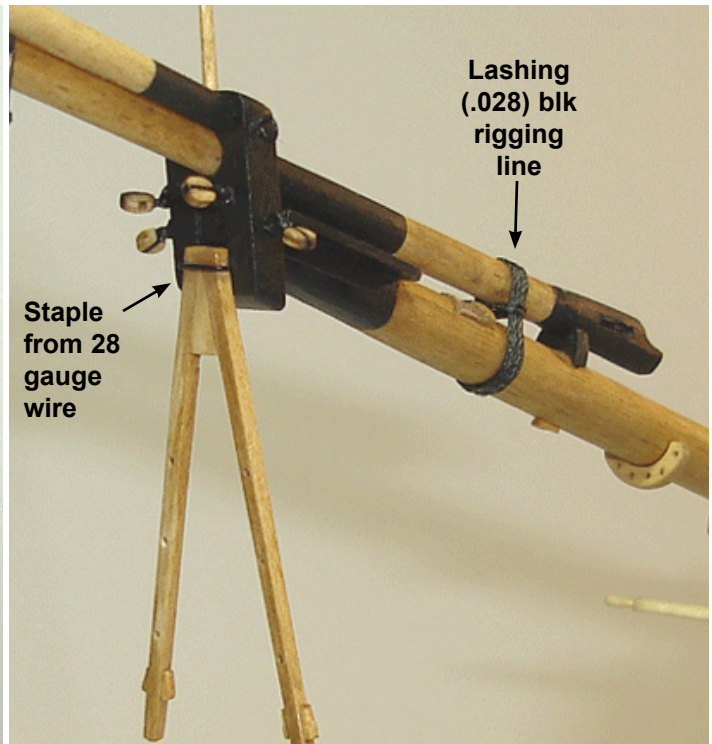
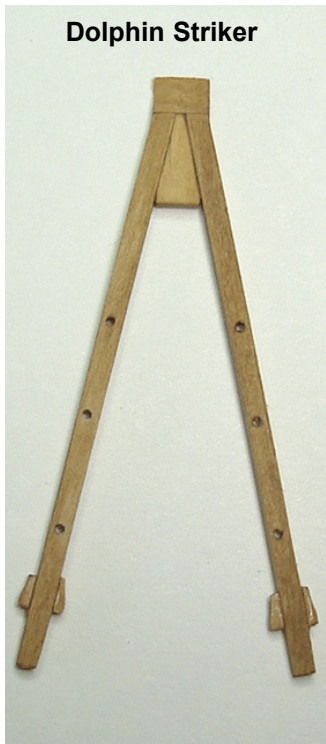
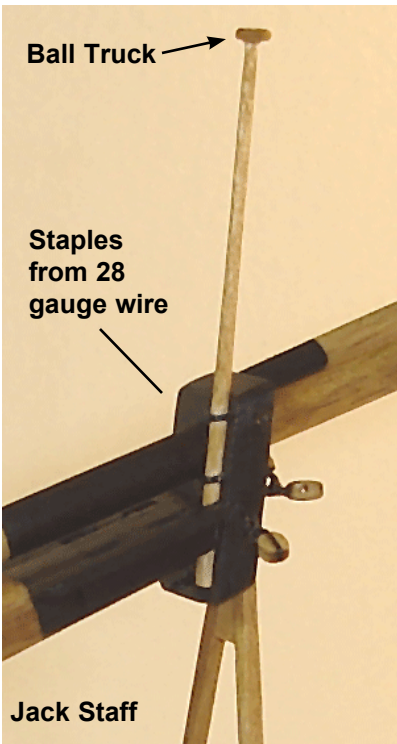



Bowsprit collars are added before mounting the assembly on the model.

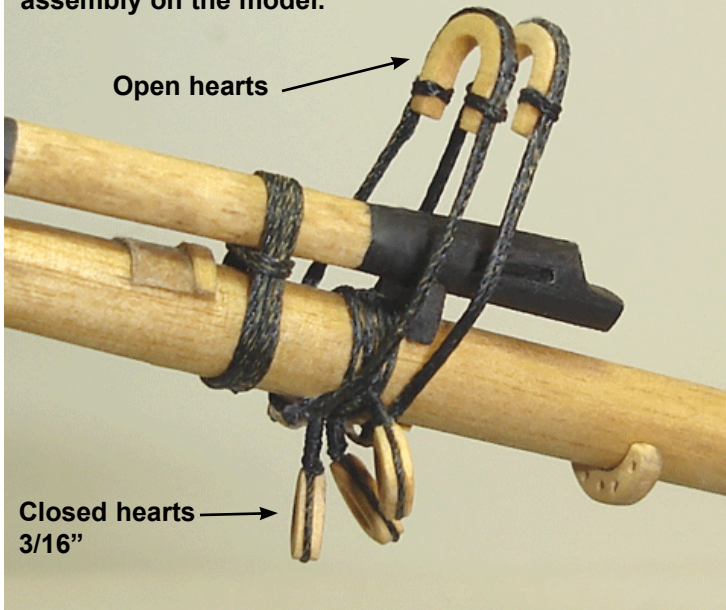

Laminating the two layers of the splash guard in the jig

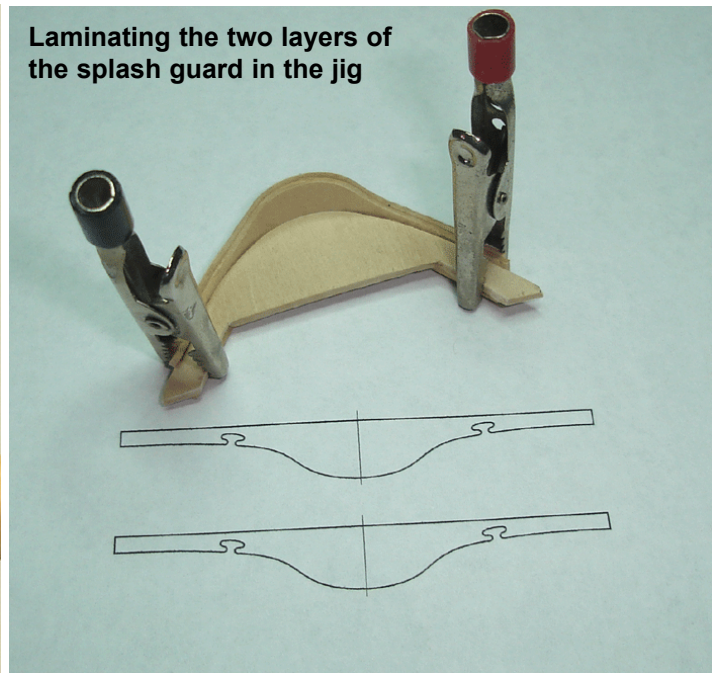

filed on an angle in order to sit properly. Test it periodically as you shape it. Be careful not to damage the top of the figurehead in the process. The tenon on the heel of the bowsprit should fit nicely into the bowsprit bitts. This will create the proper angle for the entire bowsprit assembly. The bowsprit should be between 1/16" and 3/32" above the top of the figurehead. Adjust your notch at the bow accordingly until the angle is in that range. Then glue it into position permanently.

Sitting on top of the cap rail and the bowsprit is a splash guard. This splash guard has a fairlead notched into both sides. See the plans for details. The splash guard is made in two layers which are 1/32" thick. They are quite fragile as laser cut since the grain of the wood runs top-to-bottom. This will allow you to bend them with ease around the sharp bend of the bow. The two layers will be lami-

nated together with the aid of a jig. The jig is laser cut for you. Glue the two layers together using either white glue or yellow carpenter's glue. **DO NOT USE CYANO.** You want the two layers to adjust themselves as you clamp them into the jig. Clamp both glued layers into the jig quickly before the glue sets. See the photo provided. The jig is cut to approximate the curve at the bow and the splash guard will hold that shape when the glue dries.

You will notice that the two layers don't have the fairleads cut into them yet. The larger notch on the bottom of the splash guard will need to be shaped as well. The pieces would certainly have split along the grain had they been cut ahead of time. Once the glue dries you can use a round file to create the larger notch on the bottom of the piece. It should sit nicely on top of the bowsprit. The notch should be filed at an angle to match the angle of the bowsprit. Mark the locations for the small fairleads on each side of

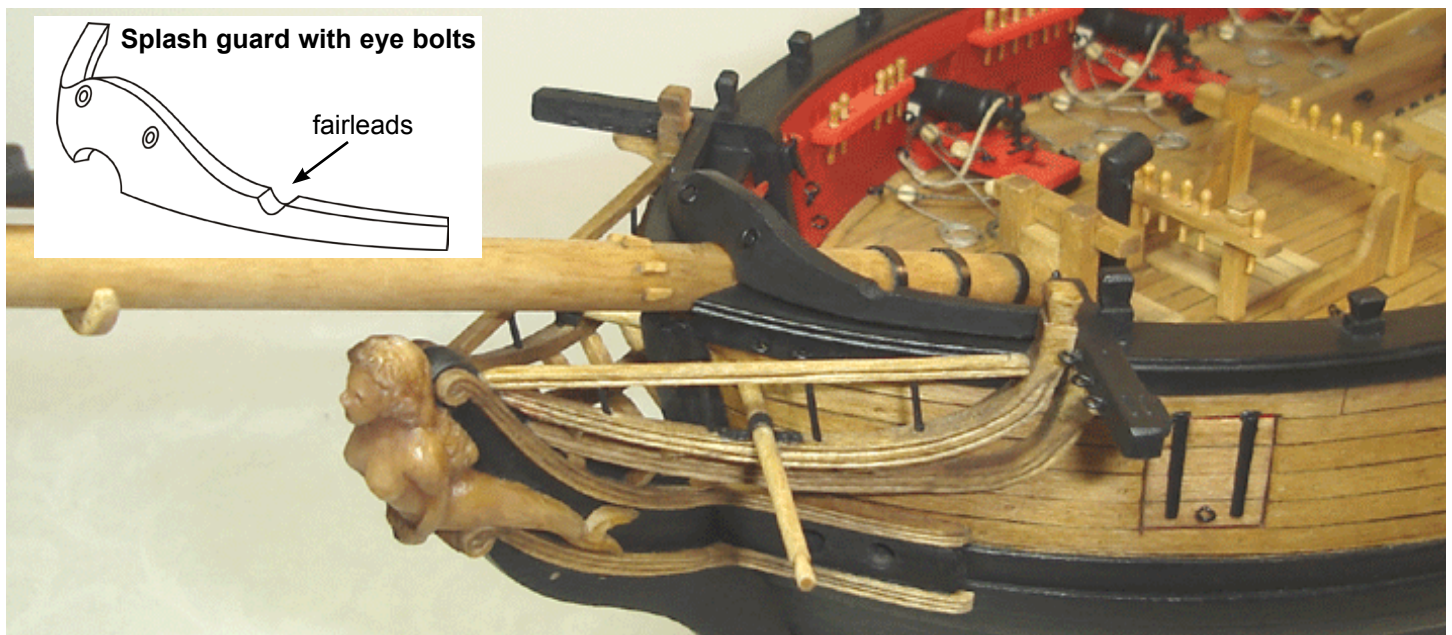
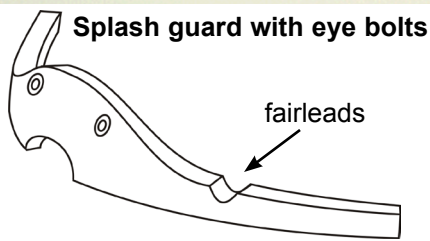



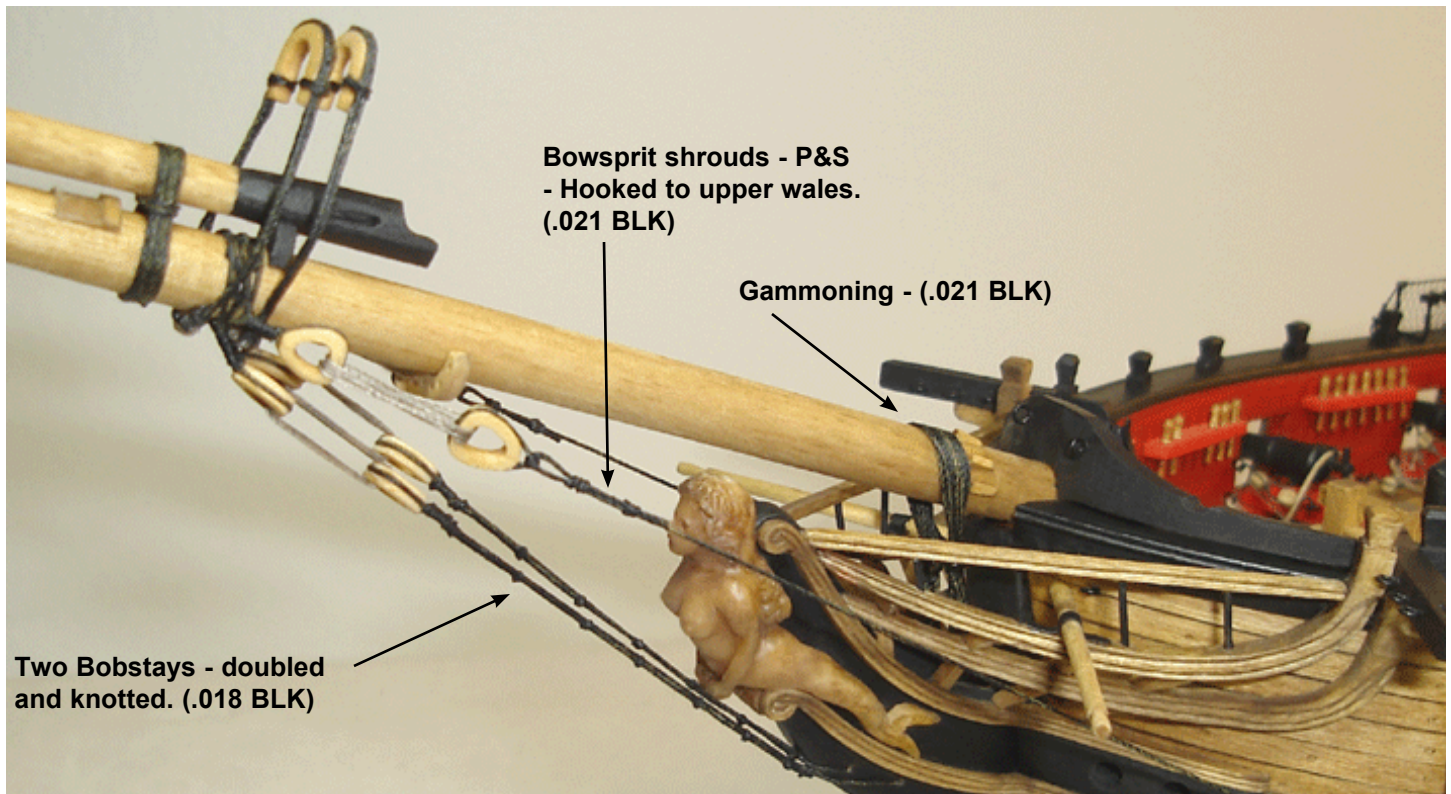

the splash guard. Don't file them into the splash guard yet. Instead, wait until after you glue the splash guard into position.

Create a simplified notch to represent each fairlead. The more complex shape shown on the plans would be very difficult to create at this scale. There is a high probability that the splash guard would split while doing so (even after it is glued into position). Use a small round file to create the simplified notches. The fairleads should run parallel to the centerline of the ship. Add two eye bolts on the fore side of the splash guard and paint it all black. See the photo showing the splash guard painted and positioned at the bow.

Some of the rigging on the Bowsprit can be done at this time. The details are listed below and presented in the order they were completed on the prototype.

**The Gammoning** on the bowsprit was rigged using .021 BLK line. See the illustration on the next page for the typical gammoning on a ship like the Syren.

**The Bobstays (.018 BLK)**- There are two bobstays that need to be set up with closed 3/16" hearts. Lash them to their corresponding hearts with .008 tan rigging line. Try and keep the space between the two hearts consistent. The bobstays are doubled their entire length and many knots are tied along their length. See the plans for details. Run only a single strand of each bobstay through the holes on the stem and carry it back up toward the hearts. This will create the doubling. Then tie some overhand knots along their length and secure them with some super glue. Use a nail clippers to cut off the excess from the knots.

**The Bowsprit Shrouds (.021 BLK)** - Seize a generous length of .021 BLK rigging line to a 3/16" closed heart. Lash it to the corresponding heart on the bowsprit. There will be two bowsprit shrouds (one on each side). Keep the spacing between the lashed hearts consistent. Create a hook from some 28 gauge black wire and hook it onto an eye bolt on the hull. The eye bolt is glued into a pre-drilled hole on the upper wales as shown on the plans. While the hook is in position you can run the loose end of the shroud through it. Pull it taught but not overly tight. You don't want to pull the bowsprit out of alignment. Use a drop of super glue to secure the line temporarily so you can seize it securely to the hook. Then trim the excess line from the seizing with a nail clippers. The nail clippers is a great tool for rigging your model. The clippers will allow you to trim the line closely to any seizing or knots.

**Inner Martingale Stays (.018 BLK) P & S** - Seize the rigging line to the tip of the jibboom as shown on the plans. Take the loose end of the stay through the top hole of the dolphin striker. Then run it through the inner-most hole of the fairlead under the bowsprit. From here you will need to set it up with a lanyard at the bow. The Inner Martingale stay will be secured to the eye bolt closest to the bowsprit among the three eye bolts at the bow.

On the actual ship these lines would have a bullseye spliced into their ends. This would be lashed to the eye bolt with a lanyard. On our little model the scale prevents us from using actual bullseyes. Instead we will simulate them by siezing an eye onto the end of the stay. Determine the length of the stay ahead of time by holding it up close to the eye bolt on the bow. Don't apply so much tension that the jibboom is pulled downward and bent out of alignment. Form the eye and apply some super glue to it. Then take a



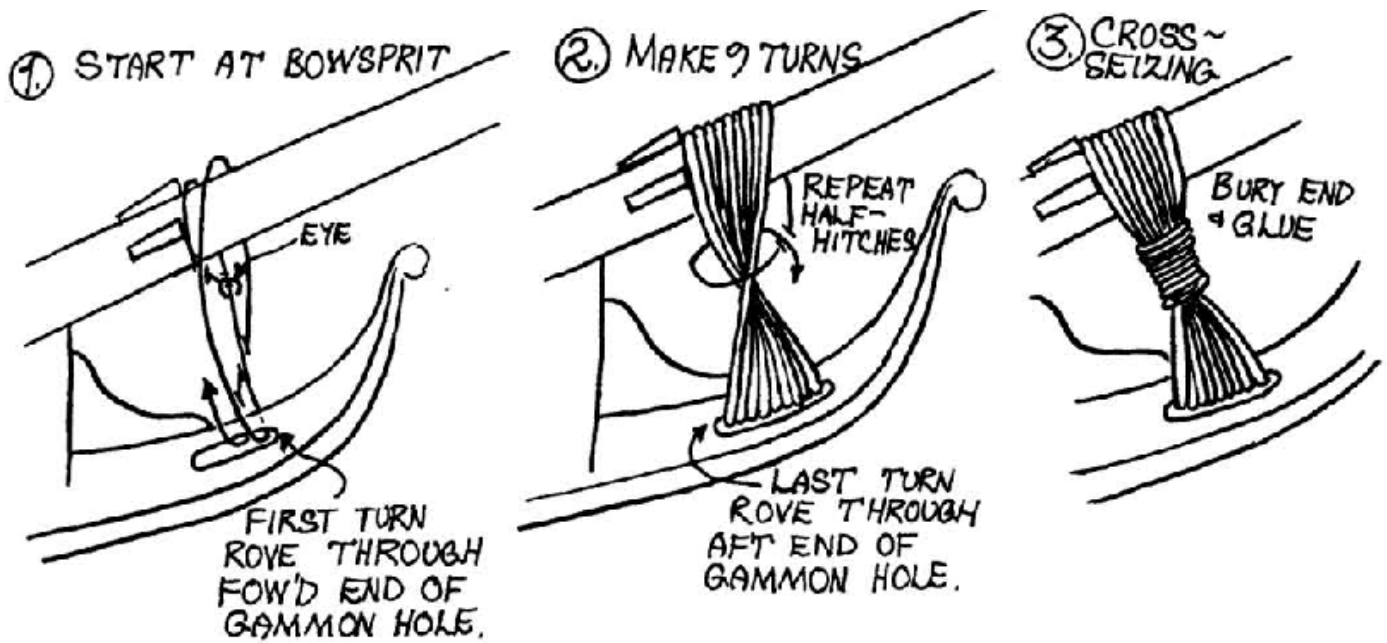

sharp awl and insert it into the eye. Twist the awl to help form it into a round circle. The super glue will dry quickly and preserve its shape. Remove the awl and apply another final coat of glue on the eye. The eye will be quite stiff when dry and does a good job of simulating a bullseye. Keep in mind all of this needs to be accomplished while the stay is rigged through the dolphin striker and fairlead. Depending on your skill level you may opt to simply seize the line at the bow rather than form a lanyard through

a simulated bullseye. The choice is yours. Finally use some tan sewing thread to set up the lanyard at the bow. See the photo which shows the stays set up in this manner. Touch up the glued bullseyes with some black paint since the glue will dry shiny and that is undesirable.

**Outer Martingale Backrope (.012 BLK) P & S** - is seized to the bottom of the dolphin striker. The cleats will keep the back rope positioned correctly. The loose ends are



Note how the Martingale stays and back ropes are set up at the bow. Simulate the bullseyes by forming an eye and stiffening them with some super glue. Lash with tan sewing thread

Bowsprit shrouds hooked to eye bolts



A close up view of the bowsprit rigging through the dolphin striker and fairlead.

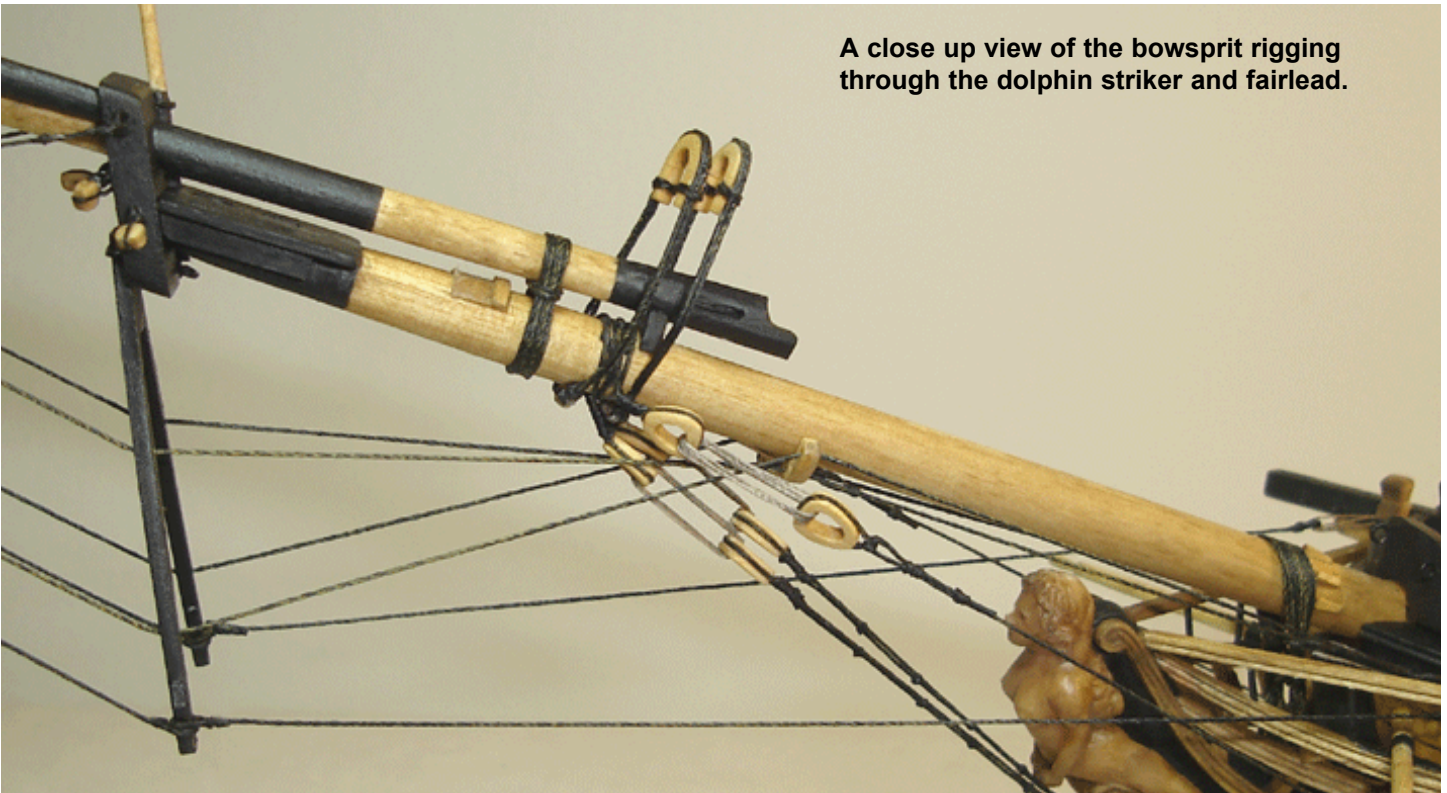

taken directly to the upper rail of the headrails. Here they are set up with a lanyard as the inner martingale stays were. Don't make these so taut that it pulls the dolphin striker back. The dolphin striker is very fragile.

**Outer Martingale stays (.012 BLK) P & S** -Seize this stay to the bottom of the dolphin striker (just under the seizing for the backropes). Then take the loose end through the 3/32" single blocks on the end of the flying jibboom. From here, run it back through the lowest hole on the dolphin striker. Then take it through the outer-most hole on the fairlead under the bowsprit. The end of this stay is set up at the bow just like the inner martingale. However it is secured to the outer-most eyebolt at the bow. see the belaying plan for details. There is a detailed view of how all of these lines are secured at the bow in the upper left hand corner of the plan sheet.

**Footropes (.012 BLK) P & S** - The foot ropes are seized to the tip of the flying jibboom and the jibboom. There are two sets on each side of the model. They are rigged separately. The larger span is actually seized to the eye bolt on the bowsprit cap as shown on the standing rigging plan. Once they are in position you can finish them off by making a series of knots spaced evenly along them. See the photo on the next page. These footropes will not lay properly unless you treat the lines first. Soak them with

water and then hang a length of line to dry. Clip some weights on the end so they dry without any kinks. This will help them hang with a more natural swag. Wait until they are completely dry before rigging them on the model. The weight of a few alligator clips on the bottom of the lines are usually enough to straighten them out sufficiently.

Touch up all of your shiny glue spots on the lines with black paint when you are finished.

You will notice in the photo below that the entire bowsprit assembly seems to be slightly bent downward. This is from the tension of the martingale stays. Try not to create excessive tension in your lines to keep this bend to a minimum. The bending shown is actually OK. When the fore stays are rigged it will apply opposite tension and spring them back into position. A little bending is OK. A lot of bending is NOT. When in doubt use less tension.

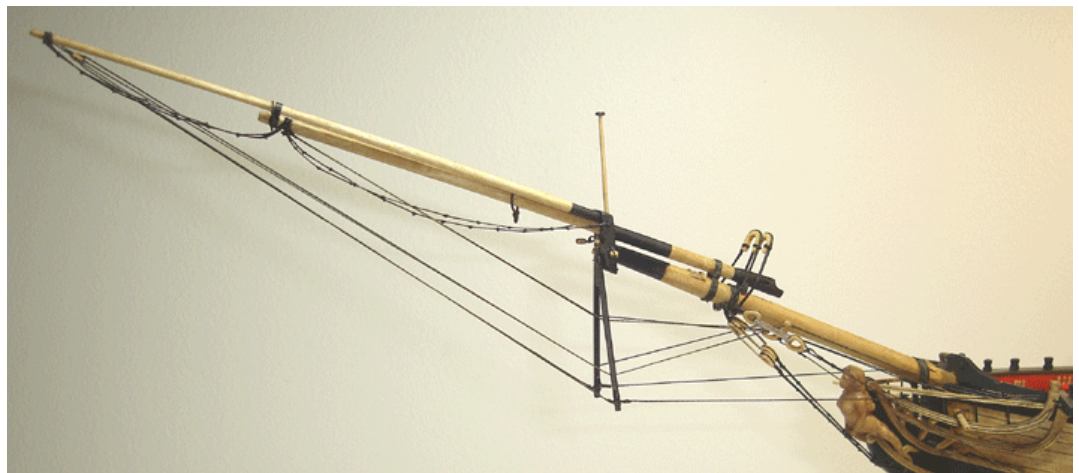



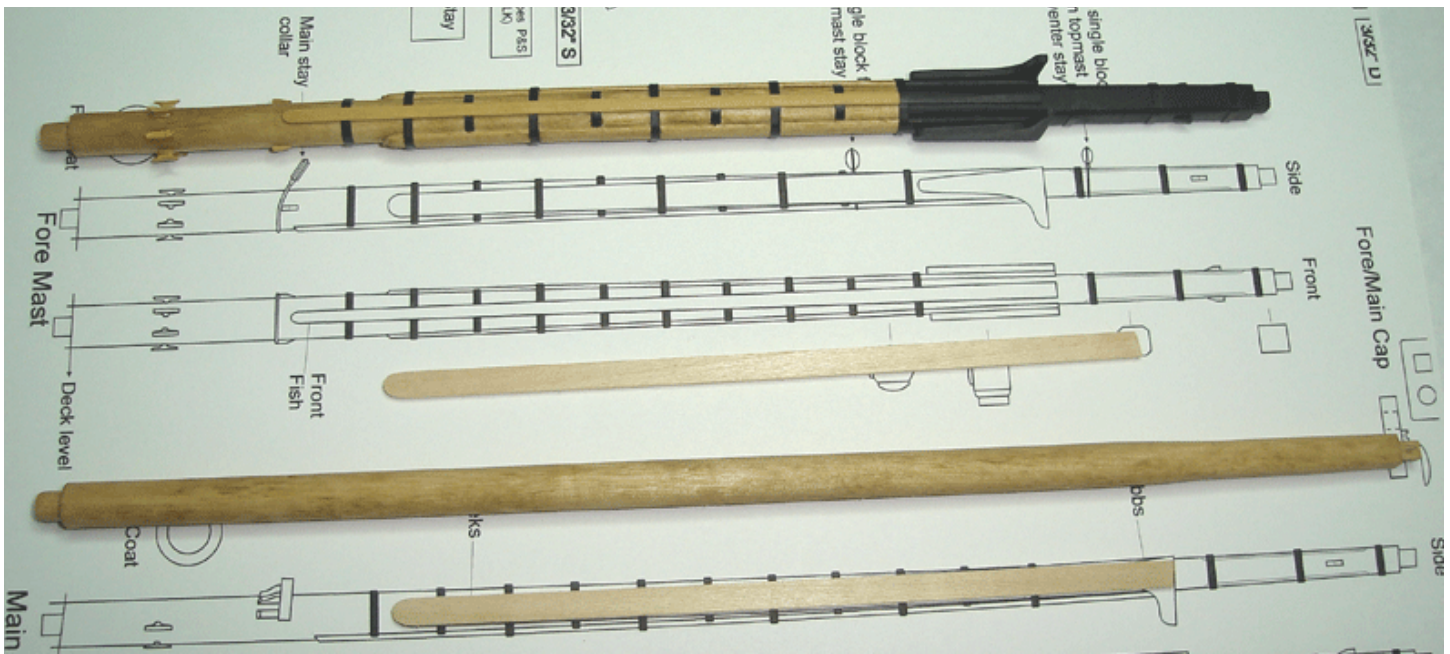

## Chapter Seventeen Main and Fore Mast Construction

We will now begin construction of the fore and main lower masts. Examine the drawing above. Both lower masts will use the same initial construction principle. Other than their length and some other small details they are built the same way. Both lower masts are shaped using a 5/16" wood dowel. The initial construction is broken down into 8 steps as shown in that drawing. A detailed discussion for each step is presented below.

**Step 1** — Cut each mast to length using a 5/16" dowel. Taper them towards the masthead. Don't taper them too severely. In fact, you should leave a little extra meat on the top of the mast where you will be shaping it to a square profile in step 2. With a sharp blade you can carve a small round tenon on the heel of each mast. This tenon should fit snug into the holes you drilled for them on deck.

**Step 2** — Using the plans as a guide, carve or sand the top of the mast to a square profile. You can use a sharp blade to quickly remove most of the material. Then use a sanding block to clean it up and establish a nice sharp edge. To help keep the four sides from twisting at an angle you can draw some pencil lines to indicate each corner first. If you do this before starting to remove any material it will help keep the squared portions from looking like they are twisting. These four sides should remain straight and maintain the taper you achieved in step one. When finished, create a square tenon on the top of the mast which will be inserted into the cap. Leave the tenon a little oversized at this point so you can come back later and tweak it when your ready to fit the cap.

**Step 3** — Chamfer the four corner edges of the squared portion of the masts. Reference the lengths and positions for the chamfered edge on the mast by first holding each mast against the plan sheet and marking them with a pencil.

**Step 4** — In preparation for positioning the cheeks onto the sides of the mast we must flatten them first. The cheeks will be made from a 3/16" x 1/16" strip. Cut the cheeks to length using the plans as guide. Round off the bottom of each cheek. You only want to flatten "just-enough" of the mast on both sides so the cheeks will lay flat against them. To give you the correct area to be flattened it is recommended that you actually tape the two cheeks to the mast. This will give you the opportunity to trace their shapes onto each side of the masts. It will also give you the opportunity to make sure they are consistently positioned correctly across from one another as they run down the sides of each mast.

After tracing the shape of the cheeks you can flatten those areas of the mast. They can be carved or sanded flat. Use whatever method you feel most comfortable with.

**Step 5** — Glue both cheeks onto the flattened areas of the lower masts. Once dry the cheeks can be sanded to their finished shape and thickness. At 1/16" they are too thick and too flat for our model. The cheeks need to be rounded to match the contour of the mast. Check the plans for details. The finished thickness on each edge of the cheeks should be closer to 1/32" than it is to 1/16". You might want to go even thinner than that along the extreme edge of each cheek but not by much. See the photo provided showing only one of the cheeks after it was shaped on the mast. You can see how the other one is too thick and still requires some shaping. The lower end of the cheeks has a carved "fingernail"-like detail. This is detail can be created using a sharp blade or by carefully filing the cheek to the proper profile. See the plans for details.

**Step 6 and 7** — Use the 1/16" wide black pinstripe tape to simulate the iron bands around the mast. You can wrap



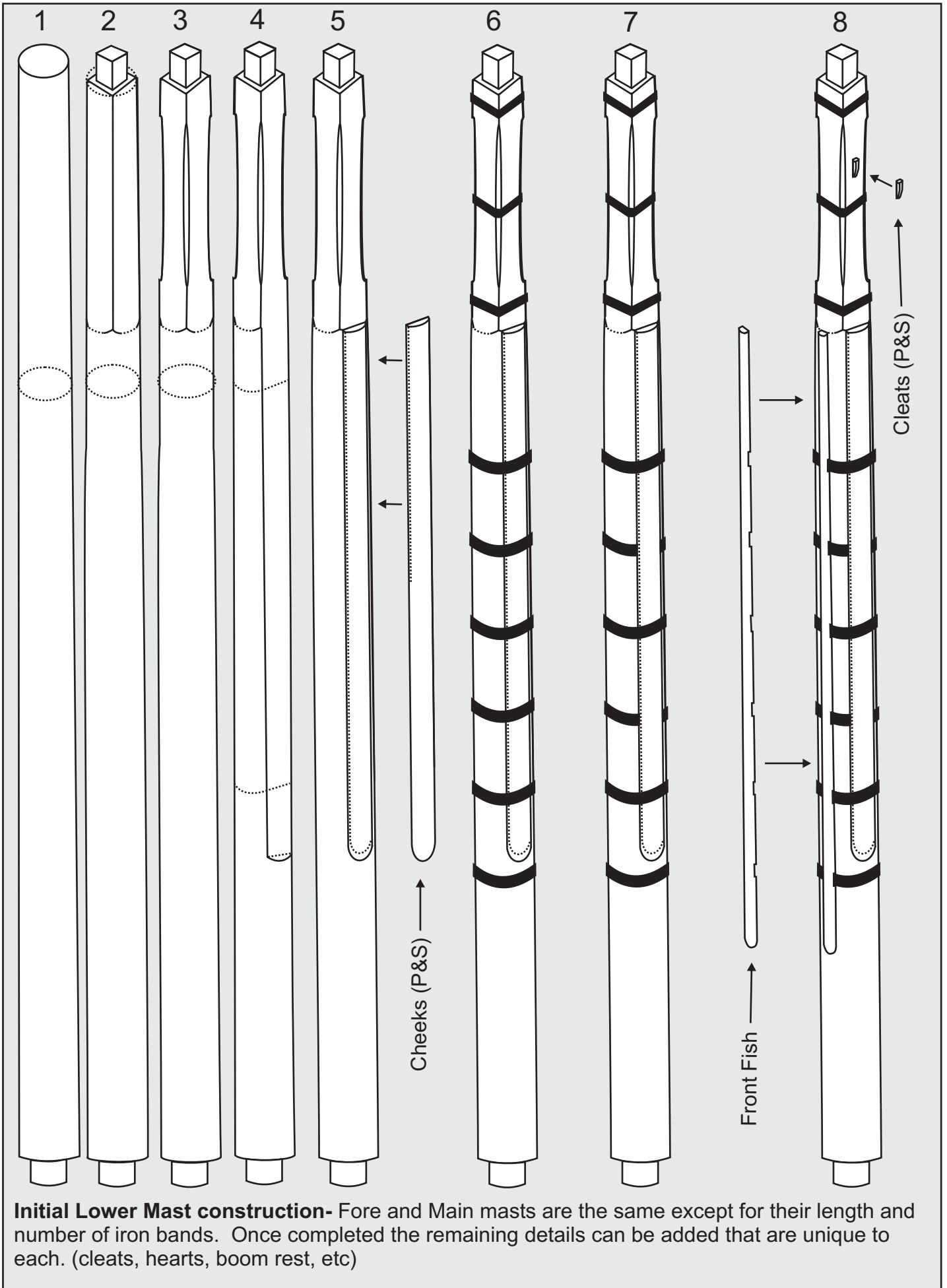



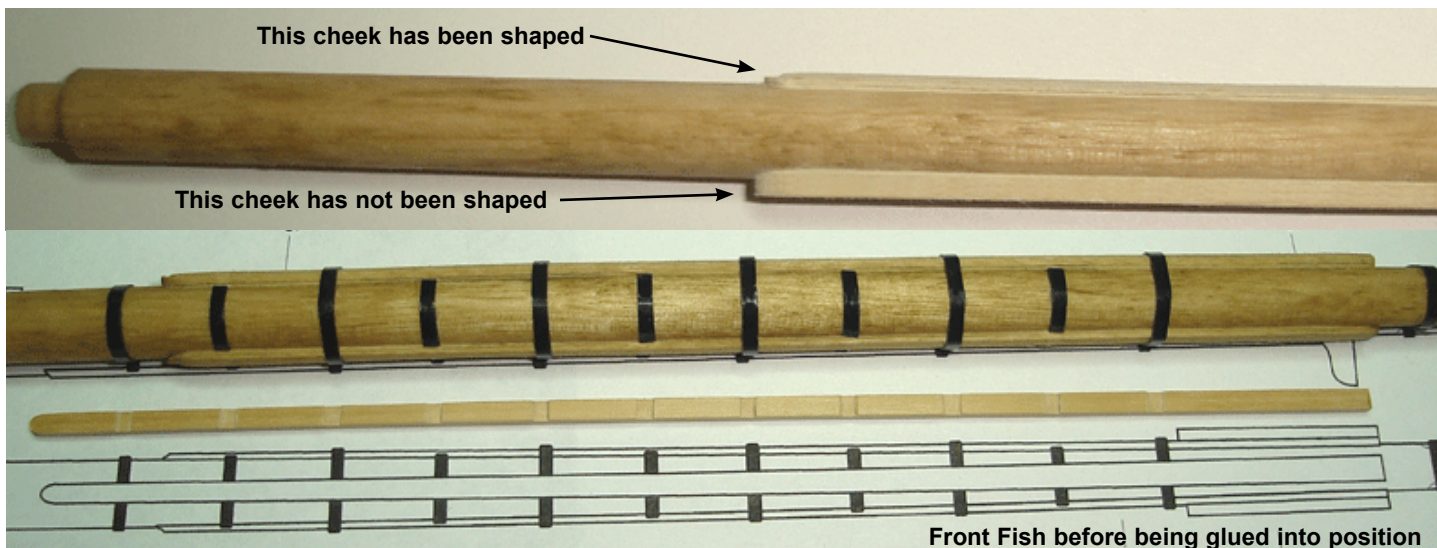

the tape around the mast two or three times which will be more than sufficient. You will notice on the plans that some of the bands are actually shown running under the cheeks. Even though this is the case, you should still initially wrap all of the bands around the entire mast. When you are finished, just use a sharp blade to cut those bands (those that appear to travel under the cheeks) close to the edge of the cheeks. Then remove the portion of the bands that sit on top of the cheeks. This will leave a nice clean cut along each cheek and do a good job of simulating them actually running underneath them. This may cause some of these cut hoops to lift up from the mast. The adhesive on the tape is not very strong. If this happens you can just use a little glue under the ends of the tape to secure them. It's better to be 100% sure that they will not start to lift away from the masts after you have a maze of rigging completed. That would make it tricky to navigate through with your tools to fix it later.

**Step 8** — The front fish will be made using a 1/16" x 3/32" strip. Cut it to length and round off the bottom as shown on the plans. The front fish is not so wide that the mast would need to be flattened as was done for the cheeks. It will sit nicely on top of the mast bands. But first you will

have to make notches along the front fish so it sits properly. Tape it to the mast temporarily and mark the locations for the notches on both edges of the front fish. Then file or carve the notches as shown in the photo provided. Once complete you can glue it onto the mast permanently.

Both masts also have two chocks/cleats located at the top of the mast head. These were made using 1/32" x 1/32" strips. They were glued to the masts prior to shaping. Just glue the "as cut" length of wood to each side of the mast. They are so tiny it is actually easier to shape them after they are glued in position.

You now have a fairly complete foundation built for both the fore and main masts. At this point it would be a great time to add those other small details that are unique to each lower mast. The bibbs for each mast have been laser cut for you (1/32" thick). Even though both masts will have a set of bibbs you should take care to position them properly. The tops will sit on top of the bibbs. If you examine the plans you will notice how both tops are parallel to the waterline. The main mast has a significant rake aft and therefore the top edge of the bibs is angled to accommodate the top as it will be situated. Use the plans as a

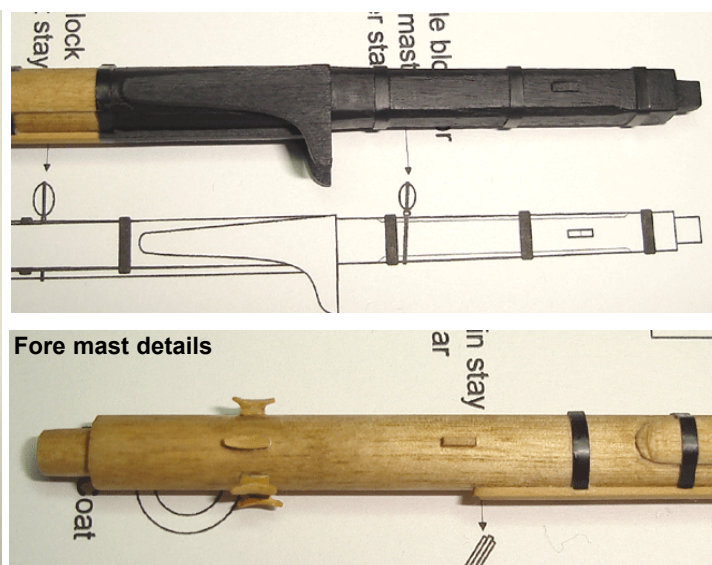
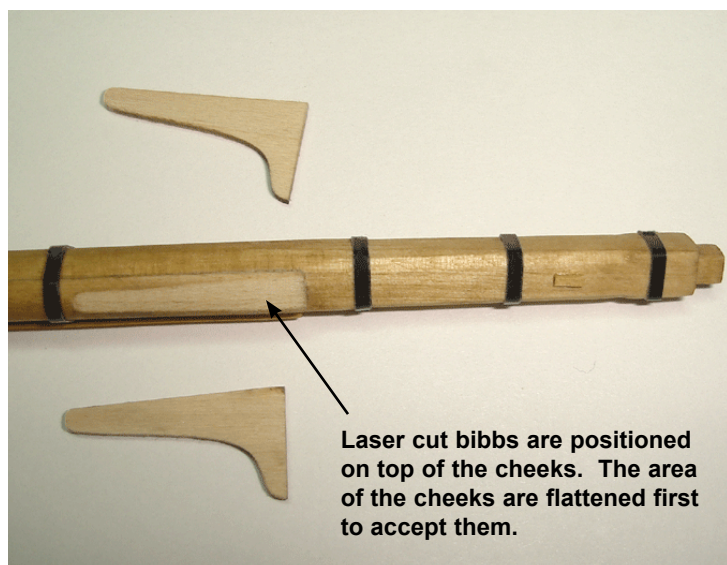



guide while gluing the bibbs into position. Remember to be conscious of the angles needed to properly position the tops in the next section of this chapter.

The cheeks will have to be flattened out before you glue the bibbs into place. So you might want to temporarily tape them into position and trace their outline onto the cheeks. Then flatten only that area so the bibbs will sit properly. See the photo provided on the previous page. To finish off both lower masts you can now add the 5mm metal cleats to the bottom of each of them. Examine the belaying plan so you can see where they are positioned. There are six on the fore mast and four on the main mast.

The fore mast also has an additional set of wooden chocks just below the front fish to help secure the heart collar for the main stay. The main mast also has a boom rest which should be constructed as shown on the plans. Use some scrap wood that is 1/16" thick to shape the top of the boom rest so it fits around half the diameter of the mast. Then create the support knees shown under the boom rest using 1/32" x 1/16" strips. Once again it might be easier to shape these knees after gluing them onto the mast. They are tiny. Note the angle shown on the plans for the boom rest.

Paint both mast assemblies black down to the first iron band as shown in the photos provided. You can also paint the iron bands with black acrylic paint to reduce the glossy finish. These bands would not have been shiny. Finally, the 5mm cleats around the base of the masts can be painted to look like wood. (Or, depending on your preferences they can also be painted black)

## Main and Fore Top Construction

Like the lower masts, the fore and main tops are nearly identical as far as construction is concerned. There are some slight differences in size, block types, and other

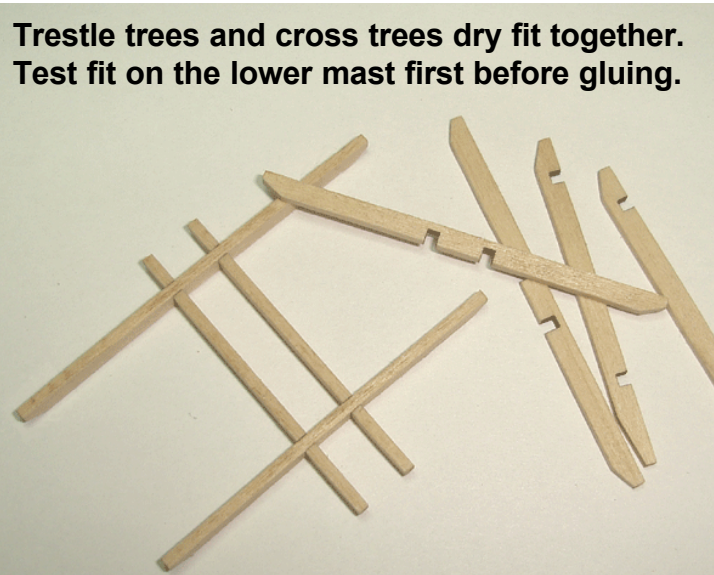

**Trestle trees and cross trees dry fit together. Test fit on the lower mast first before gluing.**

small details but essentially they can be built the same way. Begin by assembling the cross trees and trestle trees. These are laser cut for you and are 1/16" thick. Please note that an extra laser cut part for each is provided in case one breaks during construction. The aft-most cross tree is slightly longer than its forward counterpart for each top. Please examine the plans carefully for these details.

You should "dry fit" the cross trees and trestle trees together. Do not glue them together permanently yet. Before doing so it is recommended that you test their fit in position on the lower masts. There may be slight differences in the diameter of your masts in comparison to the plans. It is better to make sure that you can effectively slide the trestle trees onto the masts so they sit properly on top of the bibbs. The cleats on each mast will prevent you from sliding them into position while facing in the right direction. Turn the trestle trees at a right angle to the cleats in order to bypass them. Once the cross trees are slid past the cleats you can turn them so they are facing in the proper direction.

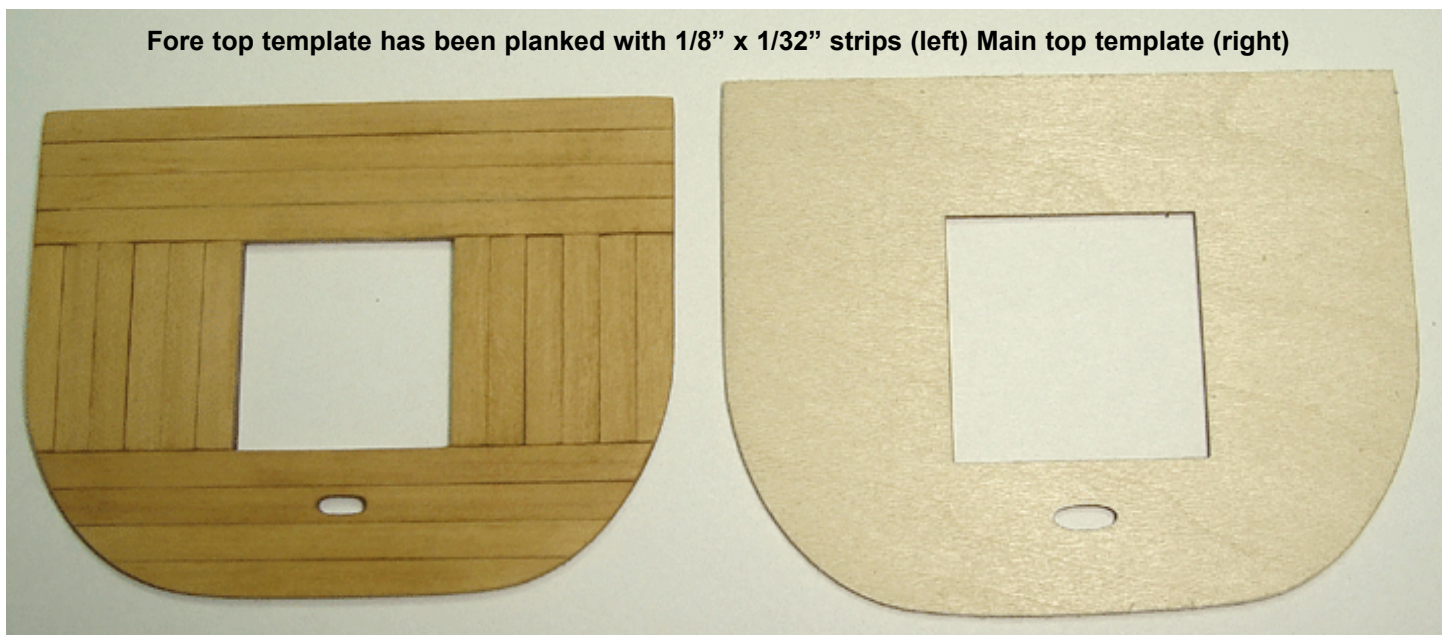

**Fore top template has been planked with 1/8" x 1/32" strips (left) Main top template (right)**



Laser cut rims have been glued into position. Main top is shown with 1/32" x 1/32" battens/chocks completed

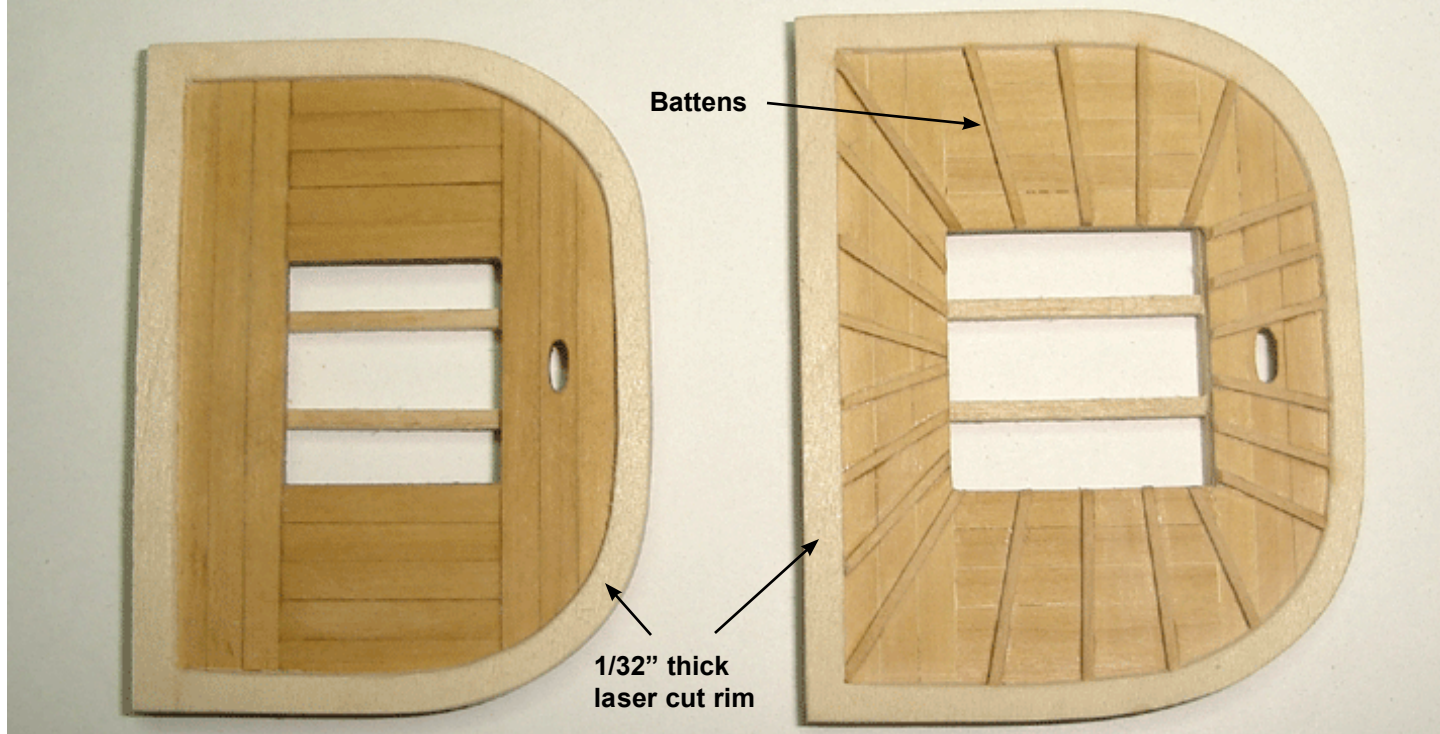

The trestle trees are flexible enough to “flex” while turning them to face forward. This isn’t such a big issue while they aren’t glued together permanently but once the tops are completed it will be the only way they can be slid into position. If the trestle trees are too close together to slide into position, simply adjust the notches in the cross trees to make them further apart.

Once you are satisfied they can be glued together permanently. Be careful while doing so to ensure the assemblies are squared up properly. See the photo provided.

Laser cut templates are provided for both tops. They are 1/32" thick. These two templates need to be planked as shown on the plans. Only the top side of each template is planked. Plank them with 1/8" x 1/32" strips. Plank the fore and aft sides of each template first. Then plank the remaining space left between those areas. See the photo provided that shows the fore top template planked and the main top template before planking. Glue the planked tops onto the crosstrees when you are finished.

After you finish planking both tops glue the rim for each into position. The rims have also been laser cut and they are 1/32" thick. They are cut slightly oversized so you can sand the outside edges of each rim flush with outside edges of the tops. There are several battens that must be glued on top of the assembly afterwards. Use the plans to determine the positions for these battens. They are cut from 1/32" x 1/32" strips. See the photo provided that shows the rim in position and the battens completed for the main top. At this point, you can glue the base strip into position for the rail. It is located on the aft edge of the tops. It does not extend across the entire width of the top. The stanchions for the rail will be pinned into holes drilled

into this base strip. A 1/32" x 1/18" strip is used for this base strip. See the photos provided. You will also notice that all of the holes for the deadeyes, blocks and stanchion pins are shown pre-drilled in those photos. This would be an excellent time to drill them. Two eye bolts are also shown in position on the fore top.

Please note that there are two methods that can be used to hang the blocks under each top. The more traditional “kit” method would be to drill some eyebolts into the cross trees and then seize the blocks to them. The positions for the blocks using this method are shown on the plans. However another more accurate method can be used instead. Depending on your experience level you can use either method. Read through the directions provided below for the alternative method and then decide which one you would be more comfortable using.

The more accurate way to hang these blocks is shown in the diagram provided below. The locations for the blocks using this method are also shown on the plans. It will require that you drill eight holes entirely through the top. This can be seen in the many photos that are provided illustrating this alternative process. The blocks are actually hung from the top and held in position with the use of a pin. In our case the pin is cut from 28 gauge black wire. Cut a length of .012 black rigging line and fold it in half. This will create a loop on one end which is pushed through the hole you drilled through the top. Push it through from the underside of the top. Examine photo A. You will see the loop protruding through the top. Simply insert a tiny length of 28 gauge wire into the loop and pull it tightly down onto it. The pin prevents the block from falling through the top. Secure the pin and loop with a small drop of glue afterwards.



**Main top w/holes drilled.  
Note Base strip for the rail.**



**Fore top w/holes drilled.  
Note two eye bolts for stays.**



Then flip the top over (photo B) and seize the two loose ends of the rigging line together. The seizing should be positioned about  $3/32$ " below the top. This detail is shown in the diagram provided earlier. Then "tie" the blocks in position with the excess of the two loose ends. A simple overhand knot will do. This can be seen clearly in photo B. Secure the knot and rigging line around the blocks with some glue. Then snip off the excess rigging line with a nail clipper. You will note that the top was NOT painted in these photos so the details can be seen better. You should however, paint the top black on both sides before securing the blocks as shown. It will be much easier to paint the tops without having the blocks dangling in your way.

A similar method is used to secure the deadeyes along the side of each top. Seize an eye on the looped end of some (.012) black rigging line. (See Photo C) The eyes

are stiffened with some super glue. Twist an awl back and forth in the eye while the glue sets. This will help form a very round eye. You can add another drop of glue afterwards for good measure. This technique is a good way to simulate the deadeye plate. Normally these were made of metal but if you create them carefully no one will know they're not. Try and keep all of the eyes a similar size and paint them black afterwards so they aren't shiny from the glue. Then pull the loose ends up through the bottom of the holes for each deadeye. Position a 2.5 mm deadeye on top of the rigging line so it has two holes across the top. Use a drop of glue to help keep it in position. Don't use too much glue as you only want to hold it steady so you have enough time to make an overhand knot around the deadeye with the two loose ends of line. Add another drop of glue to the knot and snip off the excess with your nail clipper.

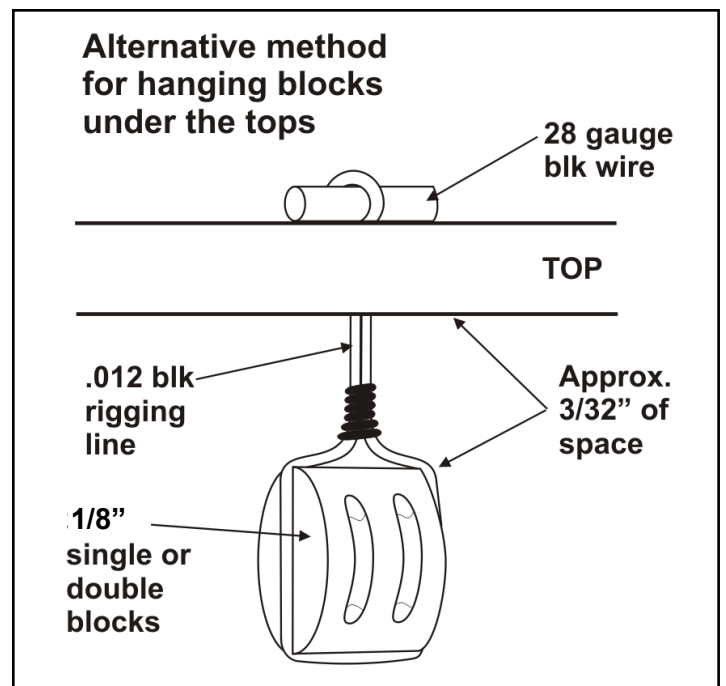
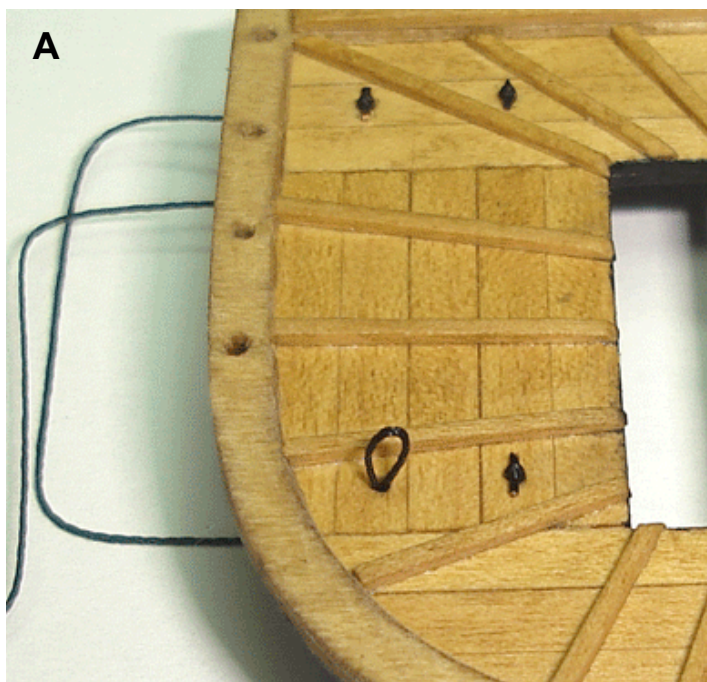



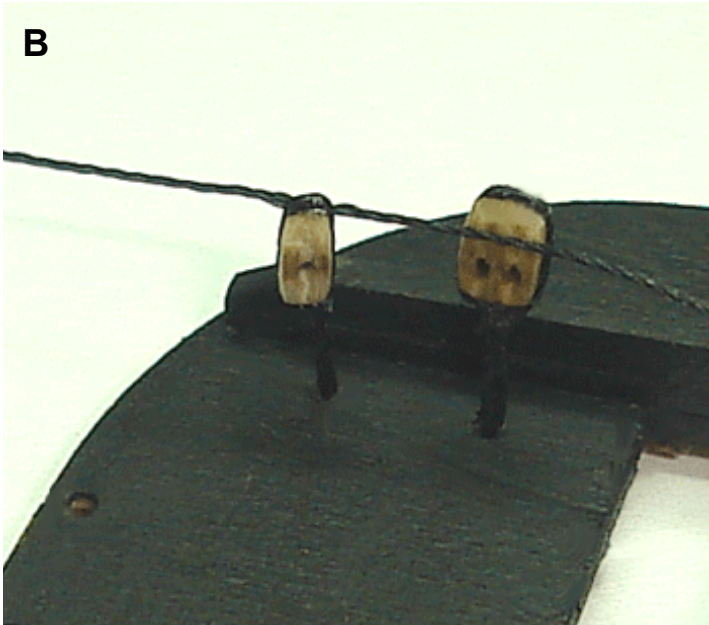

**B**

The rail positioned on each top is made using 1/16" x 1/16" strips. Use the plans to cut each piece (top rail and stanchions) to length. Glue a tiny length of 28 gauge wire into the bottom of each stanchion. The wire should protrude about 1/16" from the pre-drilled hole afterwards to form a pin. These pins will be glued into the holes you drilled for them in the base strip along the top. It will help give the railing some extra strength. If it is going to break free from the top it will most likely be along the bottom of these stanchions.

Glue the four stanchions to the top rail. But before you do so, mark the positions for each stanchion along the top rail so they line up with the holes you drilled in the base strip for pins. Otherwise they will not be aligned correctly after you glue the rail into position on the top. You can see a photo of the main and fore tops showing the rail for each. Note how the main top has a 1/8" double block hanging from its trestle trees. See the plans for details. You can add that block at this time. The rail on the main top is glued into position and painted black. The rail on the fore top will NOT be glued into place at this time. You can still paint it. You can still position it on the top. Just DON'T PERMANENTLY GLUE it into position yet. The main royal

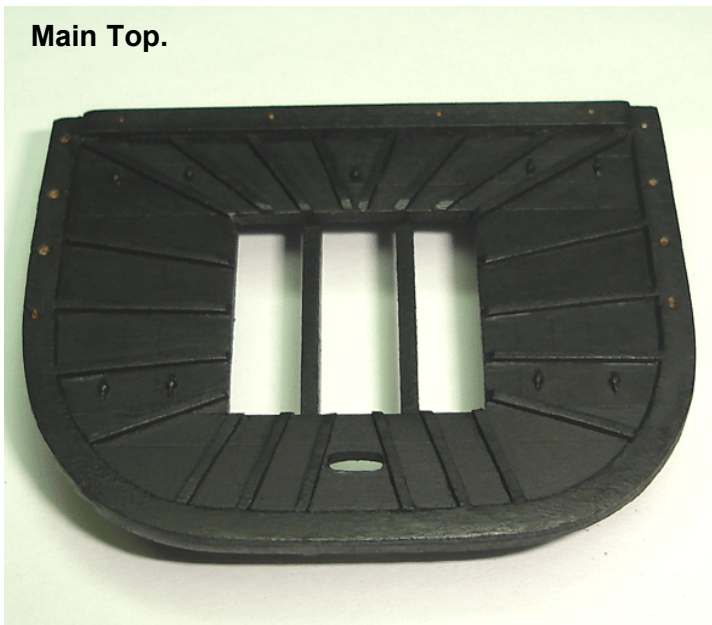

**Main Top.**

and main topgallant stays are belayed to the eyebolts you placed on the fore top. It will be much easier to set these up properly if the rail doesn't get in the way while doing so. You will be able to remove the rail to set up these two stays later in the project. After you complete that step the rail can be glued into place permanently. Note: In the photo of the fore top the rail is separated from the top in order to show the pins on the bottom of each stanchion. It has not been painted and no blocks or deadeyes have been added to it yet.

You can now position the top on the lower mast assemblies. You can mark the location of the mast onto the trestle trees first. The position of the lower mast is shown on the plans. This will help ensure that the tops are not sitting too far forward or aft once you glue them in place on top of the bibbs.

With the tops positioned, two cross beams for support can be add between the trestle trees. One is placed in front and in back of the lower masts. See the plans which show this detail on the overhead view of the trestle trees. The cross beams are made from 1/16" x 1/16" strips. Once that is completed the bolsters can be added as well. The

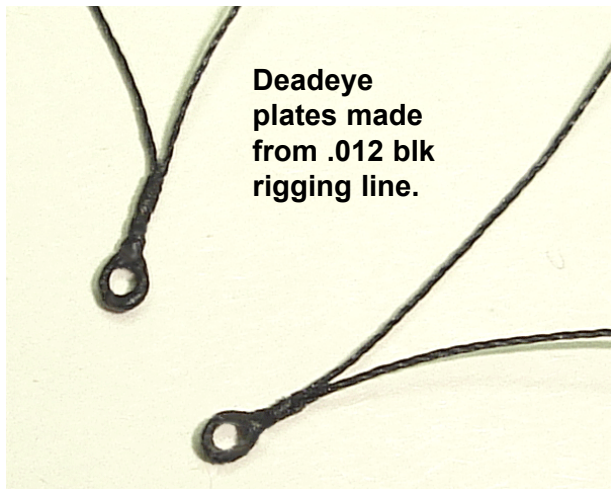

**Deadeye plates made from .012 blk rigging line.**

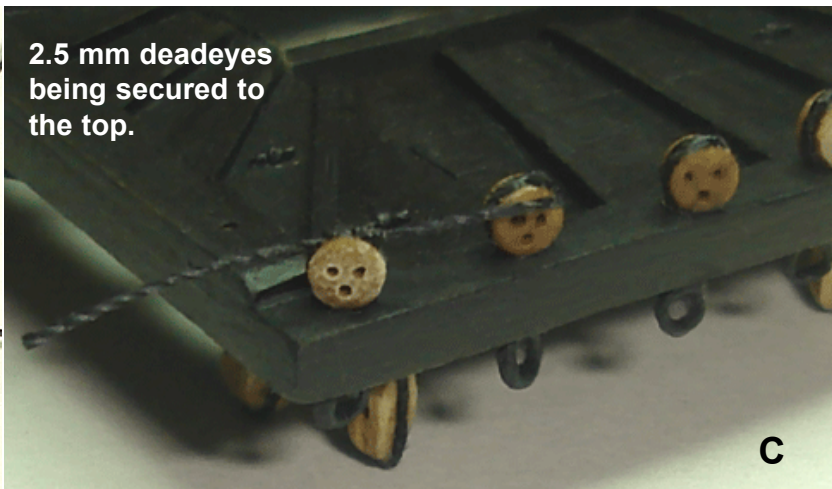

**2.5 mm deadeyes being secured to the top.**

**C**



**Main Top with rail. Note the 1/8" double block hanging from the trestle trees.**

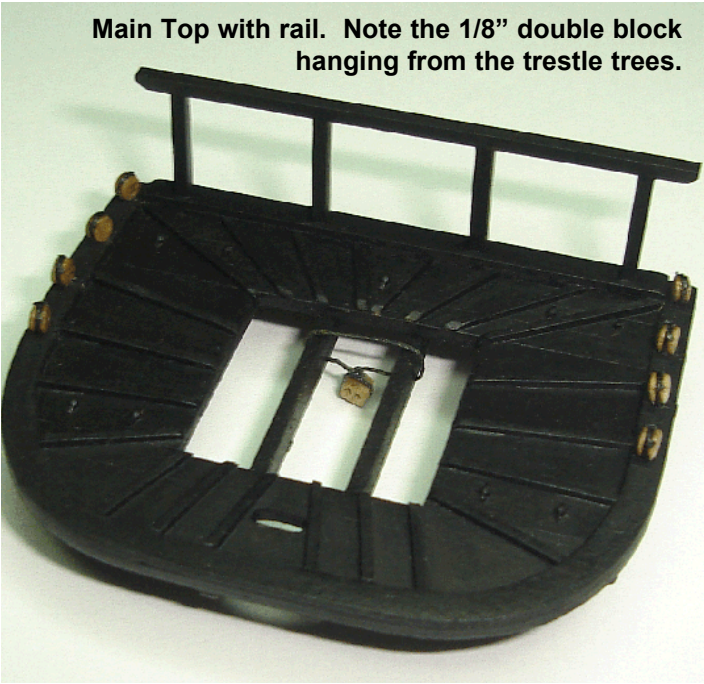

**Fore top unpainted with rail showing pins in the base of each stanchion**



bolsters are made from 1/16" x 1/16" strips and the top-outside edge is rounded off. Glue the bolsters on top of the trestle trees and paint them black along with the cross beams. You could also rig the 5/32" single block, the 1/8"

single block and main stay collar to the fore mast at this time. It will be much easier to do this now rather than wait until the masts are glued into place on the model later.

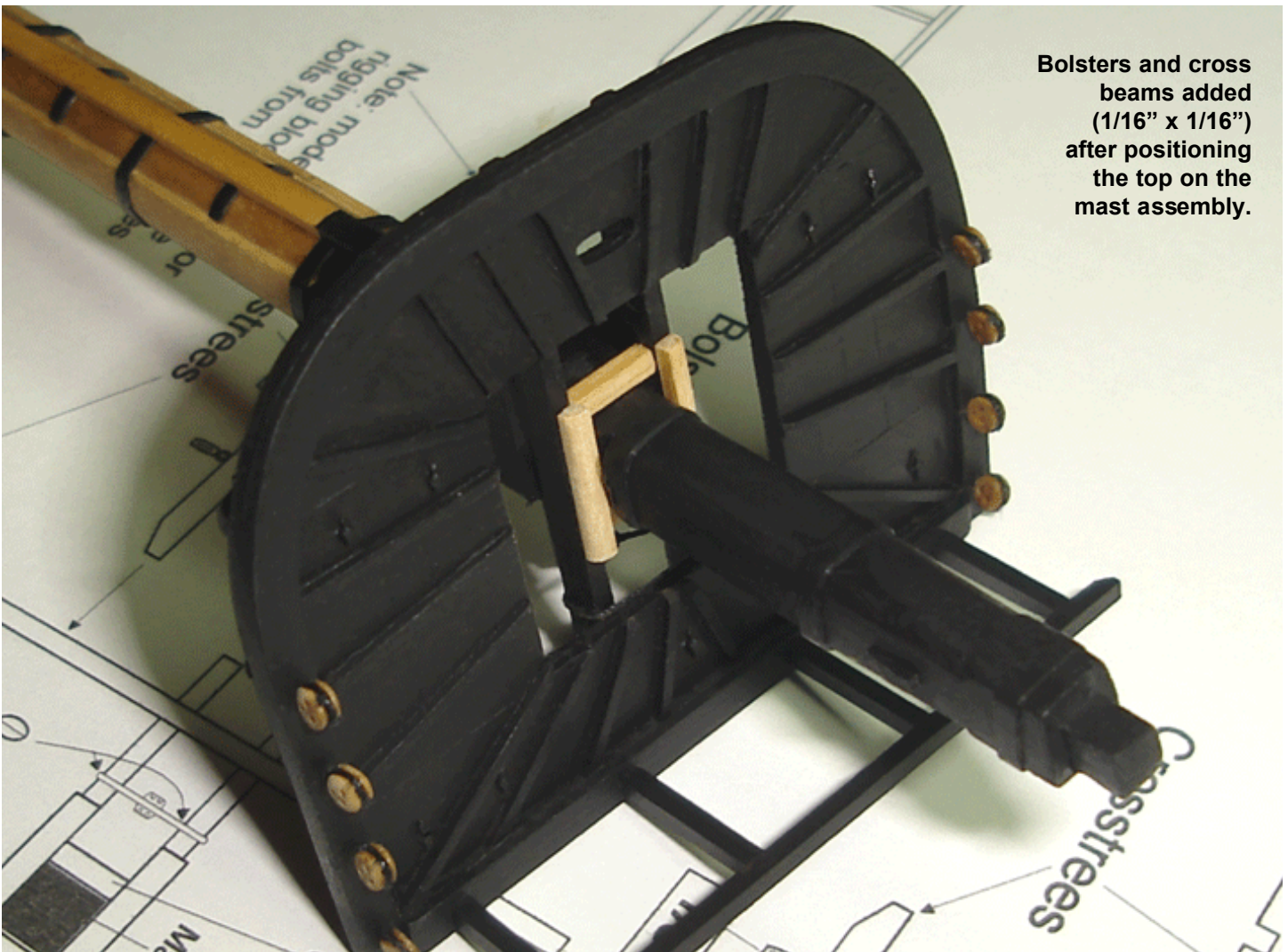

**Bolsters and cross beams added (1/16" x 1/16") after positioning the top on the mast assembly.**



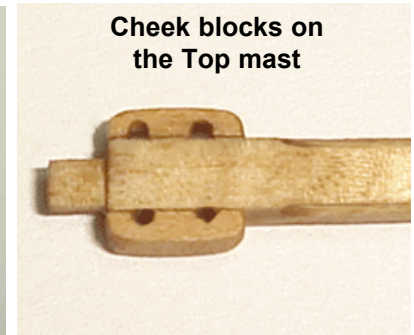

## Top Mast Construction

Both top masts are identical in construction and size for the fore and main masts. The only difference between the two is the number and types of blocks that are rigged to them. The top masts are shaped using a 3/16" dia. dowel. They are shaped just like the many other masts and spar pieces you have already made up to this point. There are segments of the top mast that are square or eight-sided. Start shaping the heel of the mast so it is square. Then further shape those portions of the heel that are eight-sided to complete it. The balance of the top mast can then be tapered as shown on the plans. But don't taper it fully. Leave it a little thicker so you can shape (squared, eight-sided, and chamfered) the other areas of the mast.

When you are satisfied that the mast is shaped properly you can drill the hole for fid. It doesn't need to be square. Simply make the hole large enough that you can slide the fid through it. The fid is shaped from a 1/16" x 1/16" strip. The fid prevents the top mast from sliding through the top.

Next you should take the laser cut cap for the lower mast and test its fit. Test that the square tenon on the top of the lower mast fits snug. Then remove the cap and make sure you can slide it onto the top mast. You will probably have to enlarge the round hole in the cap in order to slide it far enough down towards the heel of the top mast. Once the cap can slide into position on the top mast properly you should test fit the top mast in position. See the photo provided that shows the fore top mast seated properly before painting. You will also notice the saddle for the

lower yard sling glued to the top of the cap in that photo. This shouldn't be added until after the top mast is completed and glued into position permanently. There are still a few additional steps to complete first.

When you are satisfied that the top mast fits in position, you should remove it so the cheek blocks can be shaped and attached. Do not remove the cap from the top mast. You must keep the cap on the top mast because once the cheek blocks are added it would be impossible to slide the cap onto the top mast. The cheek blocks would never fit through the round hole of the cap. The cheek blocks are made from a 3/32" x 1/16" strip. Cut a small piece to length and file two small grooves on one side which will simulate the sheave holes. See the photo provided that shows the cheek blocks in position. It is probably easier to shape the cheek blocks after you glue them into position. Thin them down and re-drill the sheave holes using the grooves you made as a guide. The grooves you pre-established will help prevent the small pieces from splitting. You can now glue the top mast into position and add the saddle for the sling on the lower cap. Be sure to leave a little room between the saddle and the topmast. This is where you will secure the lift blocks for the lower yards. The saddle was shaped from a piece of 3/32" x 1/16" strip. It was rounded off as shown and a groove was filed down the center. Paint the balance of the mast doubling black afterwards.

## Top Mast Cross Trees

The cross trees and trestle trees for the top mast have been laser cut for you. They are 1/16" thick. It is recom-

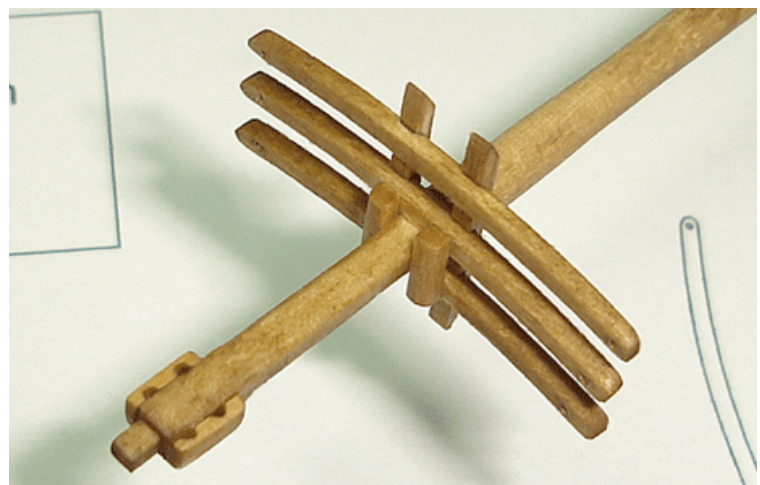
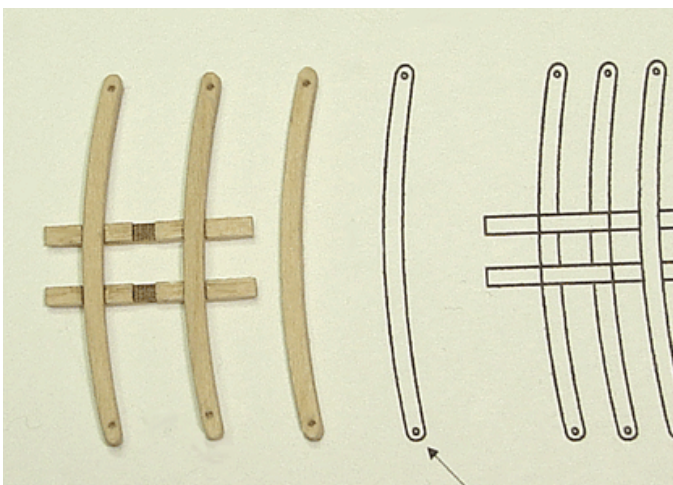



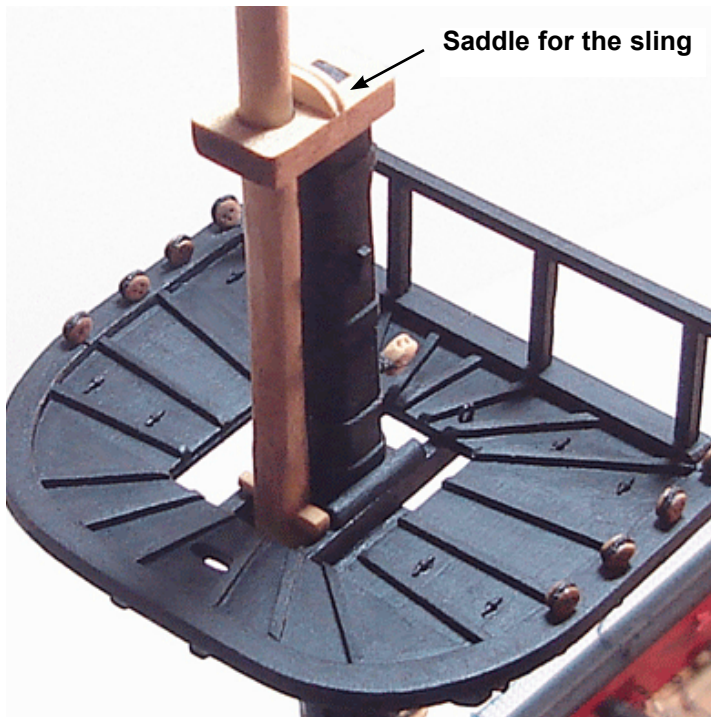

Drill the hole for the fid when you are finished. This time the fid will be shaped using 1/32" x 1/32" strip. There are also two simulated sheaves which you can create/drill through the masts. Make sure you choose a very small drill bit to avoid splitting the wood. Mark the locations for your holes on both sides of the mast first. Then drill only part way through one side of the mast. Don't apply too much pressure with the drill and allow the bit to do all of the work. Then flip the mast over and complete the hole from the other side. This will help prevent splitting and assure that the holes are made straight through the mast rather than at an angle. The bit should align itself with the hole you started on the other side if you properly marked them level with each other. Finally, you can add the ball truck on the tip of the pole. This was simply shaped from some scrap stock. But as shown in the photo provided, please remember to slide the laser cut cap onto the mast first. Once again it will be difficult to do so after the ball truck is glued into position. Test the caps fit and enlarge the holes if needed. The heel of the mast should slide snugly between the top mast crosstrees. Test the mast in position with the cap before gluing the ball truck into position.

mended that you drill the small holes on the ends of the cross tress before you remove them from the laser cut sheet. This will help prevent the fragile pieces from splitting. Assemble them directly on top of the plan sheet to insure they are squared up properly. **IMPORTANT:** Do not glue the center cross tree into position yet. Only secure the two outside trees. You will not be able to slide the assembly past the cheek blocks with the center cross tree in position. As you did with the lower top, slide the trestle trees into position on the top mast. Once they are past the cheek blocks you can twist the trestle trees so they are facing forward. See the photo provided. Once glued into place you can add the center cross tree. To finish them off shape the bolsters using a 1/16" x 1/16" strip and glue them into position as shown.

## Topgallant Mast/Pole

The topgallant masts are also the same for both the main and fore mast assemblies. They should be shaped/tapered as shown on the plans like the others. Use a 1/8" dia. dowel. This mast when tapered will get somewhat fragile. Be careful while shaping it so the mast doesn't snap in two.

## Rigging your blocks

It would be best to rig any blocks to the finished mast assemblies prior to "stepping" them permanently on the model. Many of them, especially those on the fighting tops, would be difficult to add once the shrouds and standing rigging are completed. Examine the plans carefully which show all of the lift blocks, jeer blocks and slings. See the illustration provided. There should be four blocks that hang from the top mast crosstrees as well, and a few others for the main stays. Although only a few of these blocks are mentioned here, all of them are shown on the plans along with their sizes. You will be so happy that you secured them in advance of starting the rigging. Also see some of the photos provided.

## Stepping the masts

With the mast assemblies completed, touch up any of the painted areas before moving forward. You will notice on the plans that the main mast has a noticeable rake aft while the fore mast is almost perfectly vertical. It will be important to establish these correct angles. So rather than

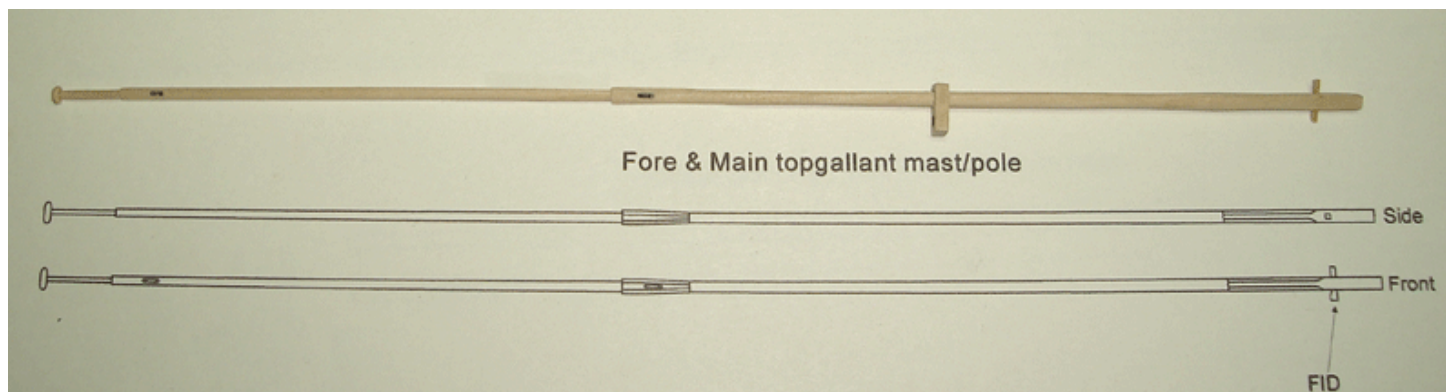



Attach all of the blocks and slings to the masts before stepping them permanently

All of the blocks are shown on the plans.

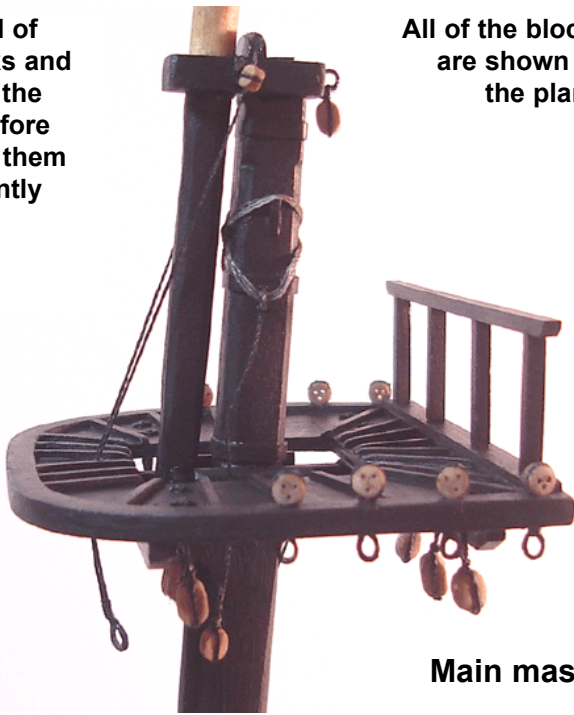

Main mast

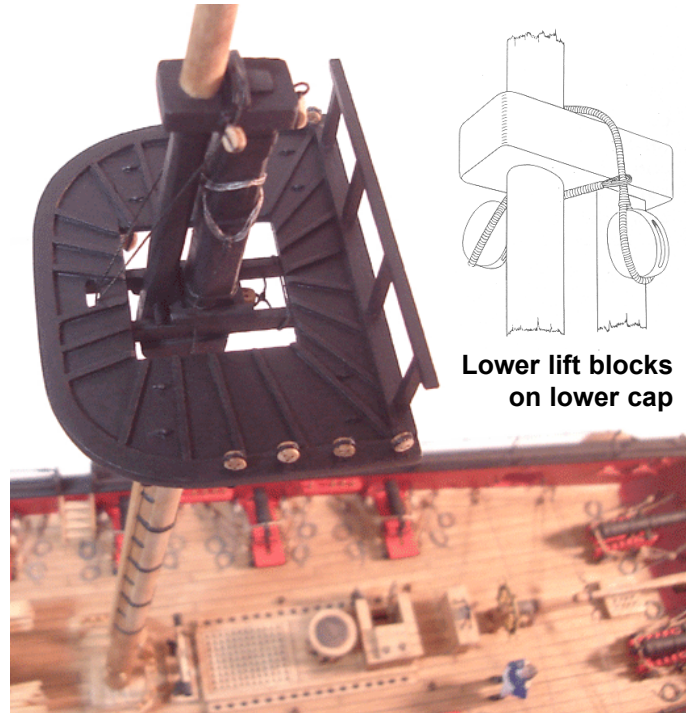

Lower lift blocks on lower cap

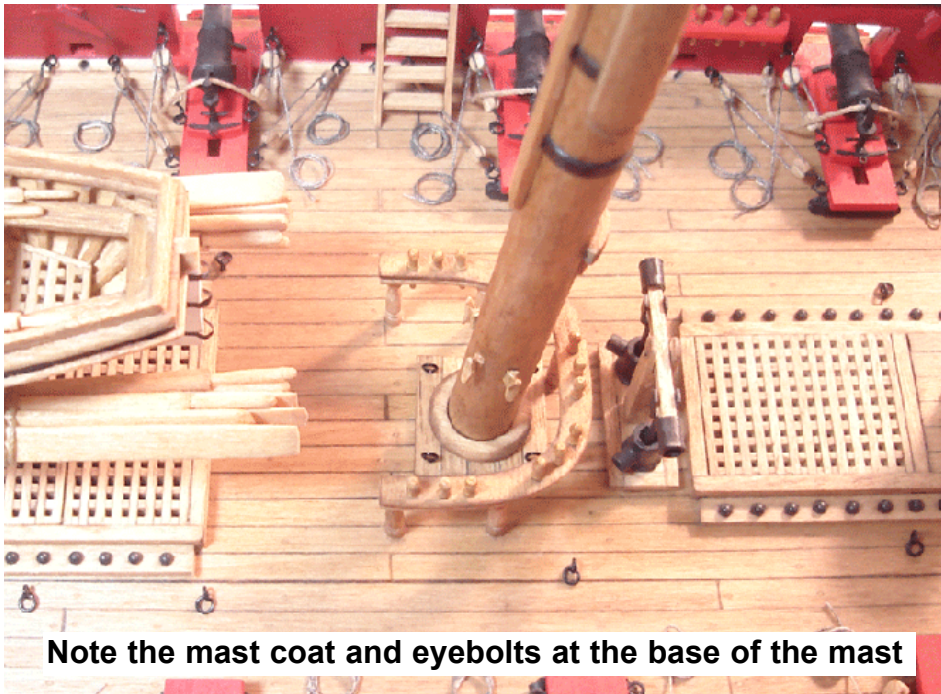

Note the mast coat and eyebolts at the base of the mast

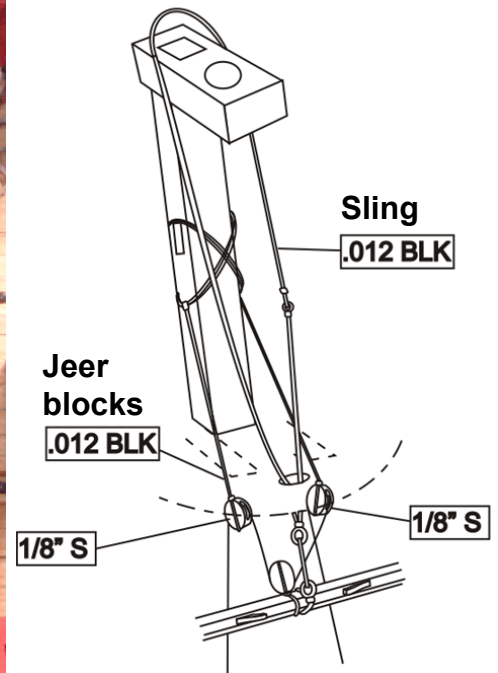

use super glue (CA) to secure them, it is recommended that yellow carpenters glue be used. This will give you adequate time to establish the correct angles before the glue dries. You will walk around the model to view it from various angles. Adjust the angles for both masts slightly until you are satisfied. The two masts should be lined up with one another when viewed from the bow and stern. But before you do so there are a few things that must be completed first.

At the base of each mast you will see the mast coat or wedges. These were often coated with canvas and tarred. Therefore you could paint them black although leaving them natural is perfectly acceptable. The mast coats have been laser cut for you. They are 1/16" thick. Round off

the top outside edges of the mast coat and slip them onto the heel of each mast assembly. After the lower mast tenons have been glued into the deck, the mast coats can be slid down into position so they lay flat on deck. See the photo provided. As with everything else, test their fit prior to final gluing.

There is one remaining step to do BEFORE gluing the masts into position. You should add all of the eye bolts that surround the base of each mast on deck. There are four surrounding the main mast and six around the fore mast. Their locations are all clearly shown on the belaying plan. Once completed you can step the masts and slide the mast coats into place as was just described.



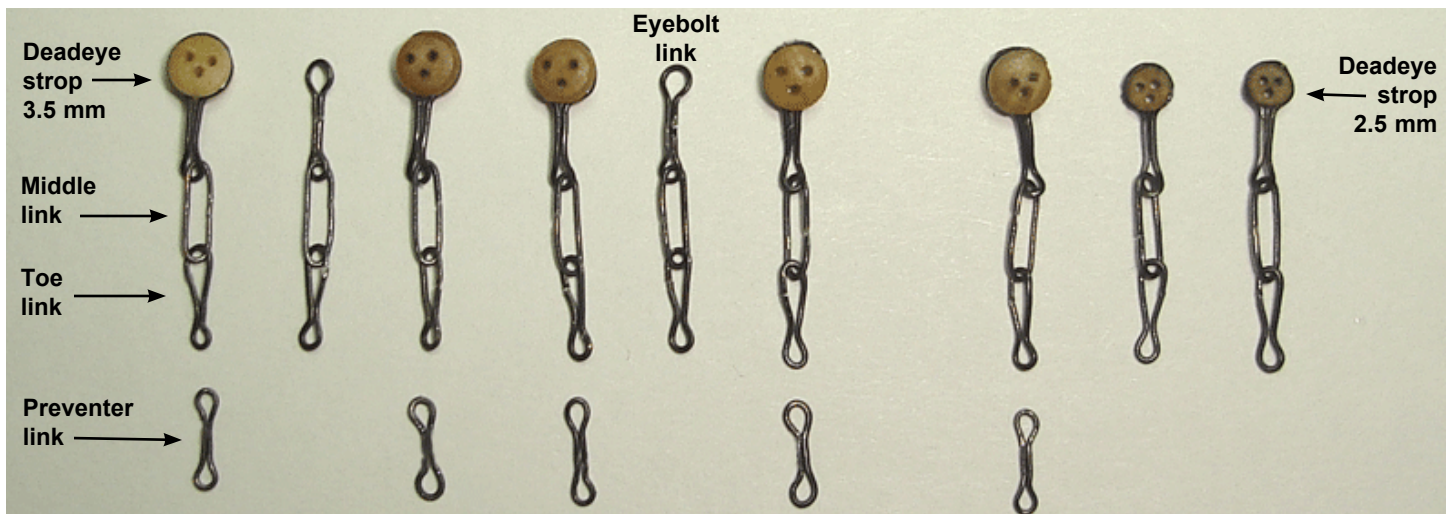

## Chapter Eighteen Standing Rigging

There are many methods and techniques which can be used to rig a ship model. One method is described here. Be sure to examine the plans carefully for all of the rigging details. The order in which the descriptions are written below is the same order used to rig the prototype model. All of the sizes for each rigging line are noted and they appear on the plans as well. To prepare for rigging the shrouds you must first create the chain plate assemblies. These assemblies are used to secure the shrouds with deadeyes and lanyards along the channels. All of the chain plate elements will be made using 28 gauge black wire. Each element can be made with the aid of a simple jig. The jig is made by inserting small nails or pins into a piece of scrap wood. The positions for the pins will be described in more detail later.

First, let's examine the different types of chain plate assemblies you will be constructing. There are three slightly different configurations. The first two are almost identical but will hold different sized deadeyes. There are 20 assemblies on the model that will use 3.5 mm deadeyes and eight that will use 2.5 mm deadeyes. The third type of assembly will not have a deadeye at all. It will have an "eye bolt" link instead. Examine the photo provided which shows the three types of chain plate assemblies required for each of the channels.

All of the chain plate assemblies have three components but those stoppered with the 3.5 mm deadeyes will have a fourth component called a "preventer link". The first of these components would be the **deadeye stoppers** used for the 2.5 and 3.5mm deadeyes. Use a scrap block of wood to create the jig. Simply insert a small brass nail into a pre-drilled hole as shown in the photo provided. Snip off the head of the nail prior to inserting it into the hole. This will make it easy to remove the deadeye stopper from the jig.

**Step 1** — Crimp a small length of 28 gauge wire around the nail as shown using needle-nosed pliers. Bend back the two loose ends of the wire while still holding it crimped with the pliers. This part of the stopper should have a length of  $\frac{3}{32}$ " to  $\frac{1}{8}$ ". Examine the photo for the details.

**Step 2** — Remove the stopper from the jig. You will need 20

stoppers with a 3.5 mm deadeye and 8 with a 2.5 mm deadeye. Make them all at this time.

**Step 3** — Glue a deadeye into the stopper as shown. Be careful while positioning the deadeye so the holes are aligned properly.

**Step 4** — Bend the loose ends of the wire around the deadeye.

**Step 5** — Trim off the excess wire. You can apply a drop of glue to the top of the deadeye to permanently secure the wire in the groove.

**Eye bolt links** (8 needed) — create a new jig with two nails. The pins should be spaced  $\frac{7}{32}$ " apart. This is measured from the outside edge of each nail. One of the nails

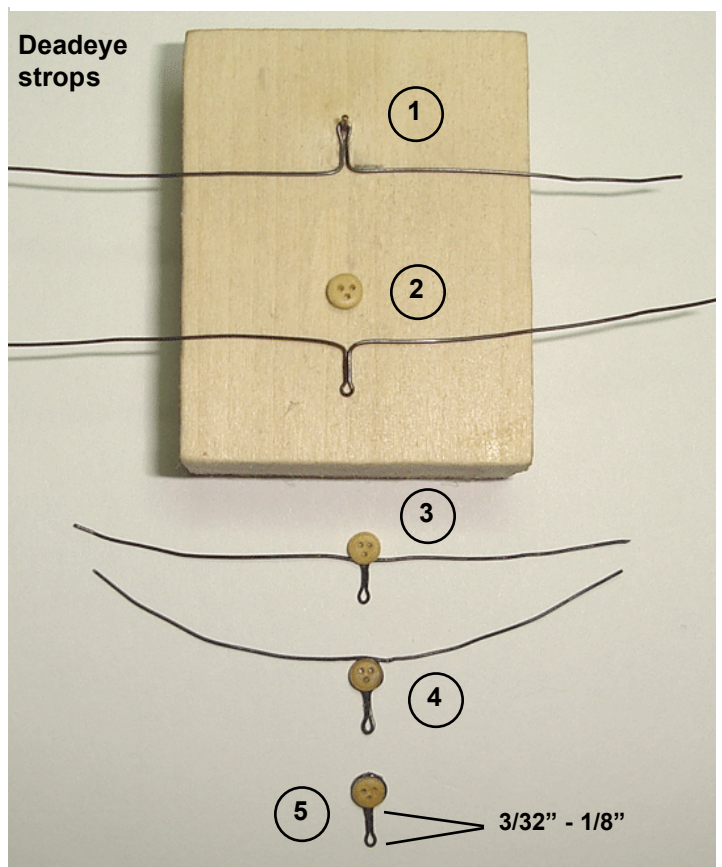



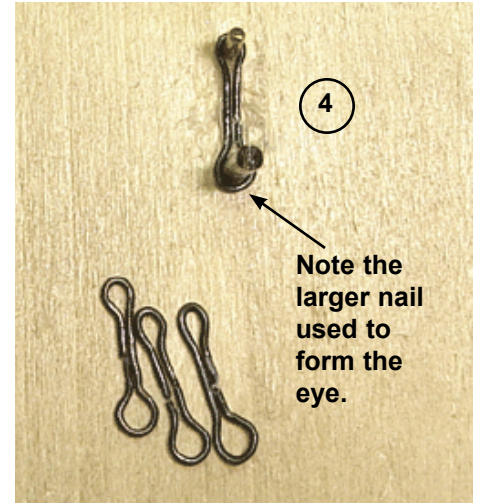
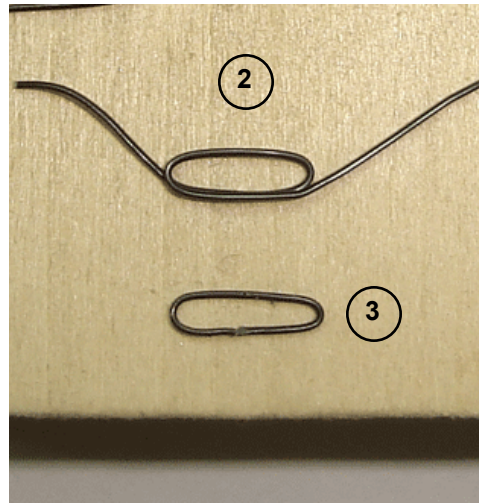
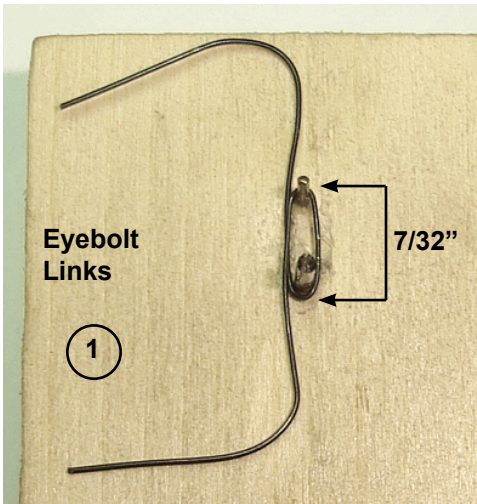

should be slightly thicker in diameter than the little brass nails supplied with the kit. A small finishing nail with the head removed would do nicely. The larger nail forms the eye.

**Step 1** — Wrap a small length of wire tightly around the two nails.

**Step 2** - Remove the link from the jig.

**Step 3** — Snip through the doubled layers of the wire on the one side of the link. This will create a perfectly formed link where the two ends meet.

**Step 4** — Place the link back into the jig. Use needle-nosed pliers to crimp the center of the link tightly around each nail. Remove the finished eye bolt link from the jig and make any adjustments to it if they are needed.

**Middle links** (36 needed) — Create another jig similar to the last one. It will have two little brass nails placed a 1/4" apart. You will also use this jig for the toe link.

**Step 1** — Bend the 28 gauge wire tightly around the two nails.

**Step 2** — Remove the link from the jig.

**Step 3** — Snip the doubled wire in the center of the one side to form the finished link.

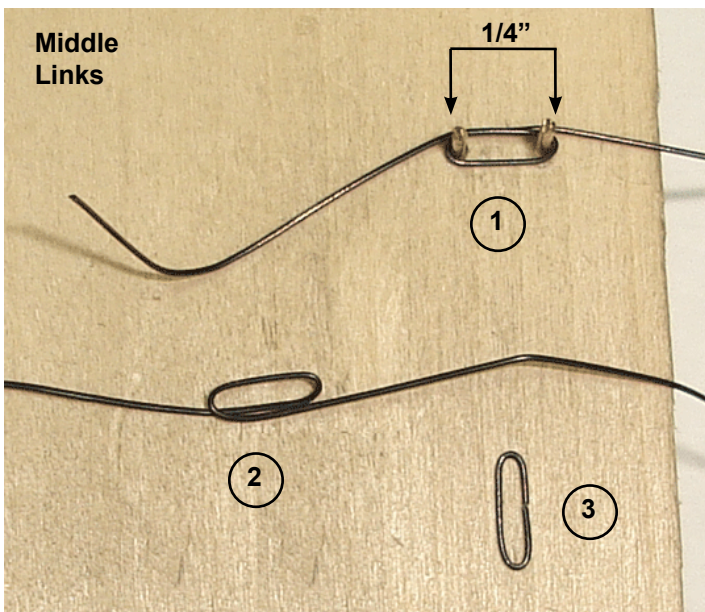

**Toe links** (36 needed) — Use the same jig you made for the middle links.

**Step 1** — Tightly wrap the wire around the two nails. With the wire still in the jig, use needle-nosed pliers to crimp one side around a nail.

**Step 2** — Remove the link from the jig and snip the doubled side with some nippers above the eye. Try and cut the loose end of the doubled side halfway between the eye and the top of the link. This will complete the toe link.

**Preventer links** (20 needed) — use the same jig you used for the middle links. The preventer links have actually been photo etched for you. But you may want to make them from scratch so all of the elements have the same appearance once they are added to the model.

**Step 1** — Follow the same steps used to create a middle link.

**Step 2** — Then place the link back on the jig and crimp both ends tightly around the nails.

Assemble all of the chain plate assemblies as shown in the first photo provided in this chapter. You can open the

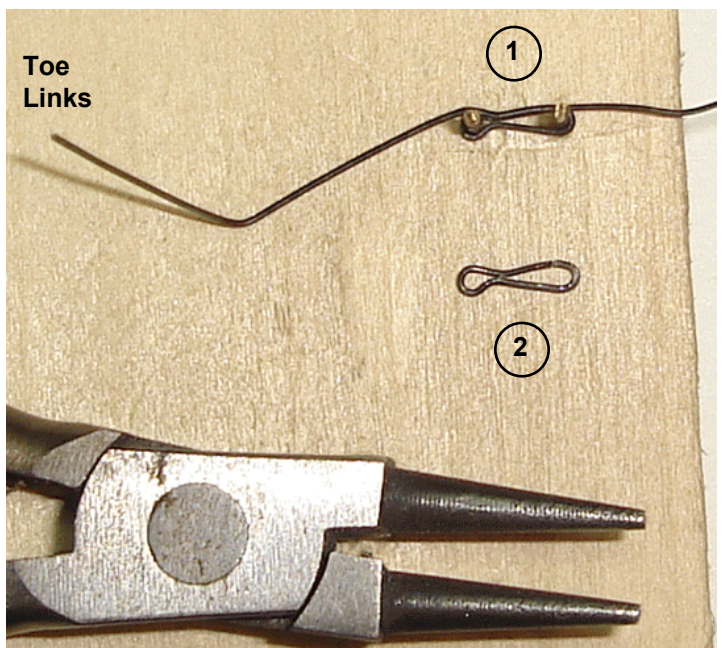



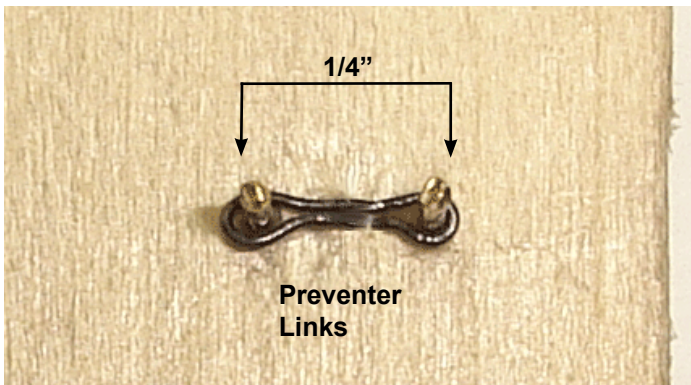

middle link up slightly and then slip the strop and toe links onto them. Once completed, you can position the appropriate assemblies along each channel. Use a drop of glue to temporarily secure them in the laser cut notches of each channel. Just let the links hang freely for now. When all of the assemblies are positioned, use a strip of 1/16" x 1/16" wood as a molding along the edge of the channel. This will lock all of the chain plate assemblies into position. See the photo provided. Round off the two corners of the molding strip with some sand paper. They shouldn't have an abrupt, sharp corner. Then paint the molding strip black.

The bottom of each chain plate is secured to the hull with nails. Those with the 3.5 mm deadeyes will require the preventer links. Examine the plans and you will see that the chains actually follow the angle of the shrouds they will secure. In order to find this angle you should rig a temporary shroud from the top. Hold the temporary shroud against the channel in front of each deadeye. Keep the shroud angled properly while locating the point on the hull where the chain plate assembly should be nailed. Put the point of a pencil through the eye of the toe link to mark this location onto the hull. See the photo provided.

Drill a hole into the hull on the reference mark. Push a small brass nail through one eye of the preventer link and then through the eye of the toe link. Then push the nail into the pre-drilled hole you made on the hull. Only push the nail part way into the hole so you can apply some glue to it before pushing it in all the way. For the chain plate assemblies not using a preventer link, just push the nail through the eye of the toe link and into the hull. For those assemblies using a preventer link (3.5 mm deadeyes), drill another hole through the bottom of the link and glue another nail into it.

If you encounter a chain plate assembly that will interfere with a port or sweep opening you must adjust the angle of the assembly. The chain plates should not get in the way of any port lid so it would be difficult if not impossible to open and close them.

**Standing Rigging** — From this point forward the instructions will document the rigging process in the exact order used to rig the prototype. All model builders will eventually develop their own rigging sequence they feel comfortable with. But until you develop your own, the sequence documented here will keep you from rigging yourself into a corner so-to-speak. It would be a good idea to read through this entire chapter before starting the process so you can get an idea of what needs to be accomplished.

**Main Lower pendants** — (.021 blk) —The pendants are seized around the main mast head. Take their length from the rigging plan. An eye is created on the end of the pendant. A tackle was usually hung from the pendants and used to lift various items on deck along with helping to raise materials up into the rigging. One pendant is rigged under the top on each side of the main mast.

**Main lower shrouds** (.028 blk) - All of the shrouds are rigged on the model in pairs. This is achieved by seizing a

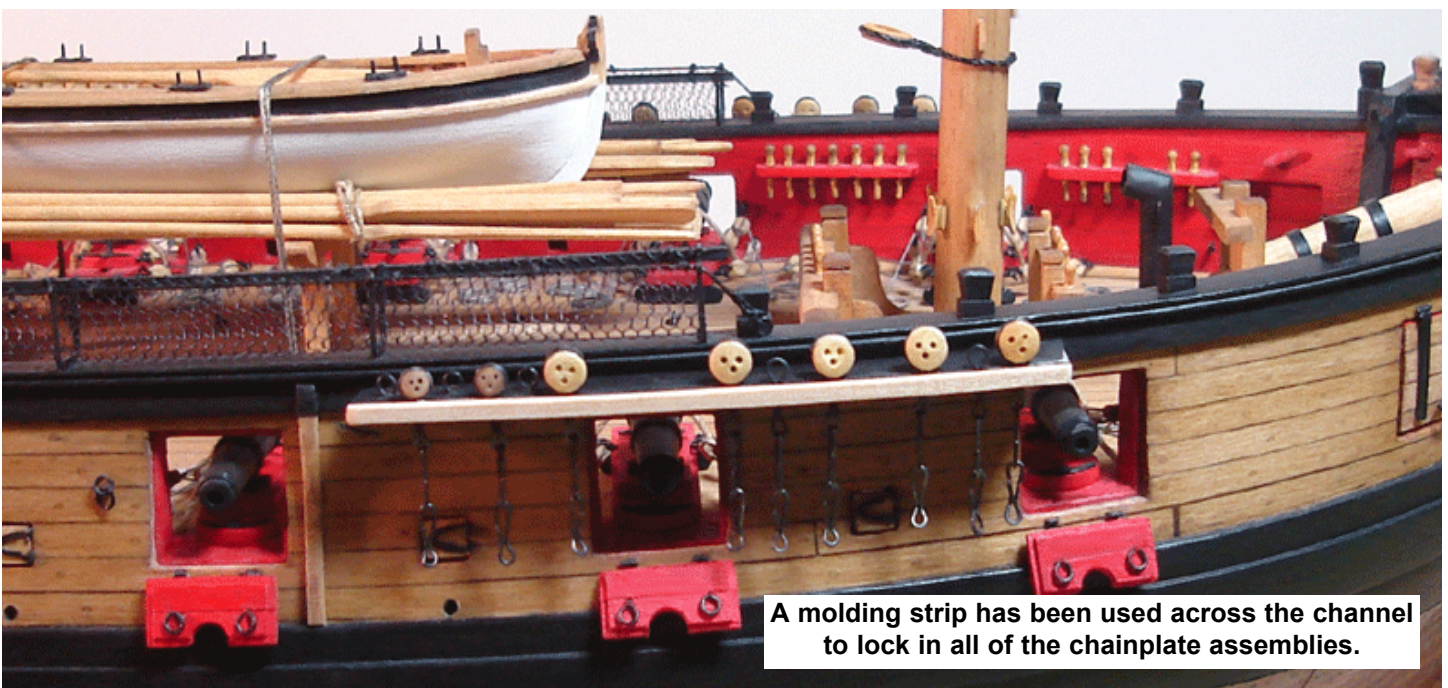

A molding strip has been used across the channel to lock in all of the chainplate assemblies.



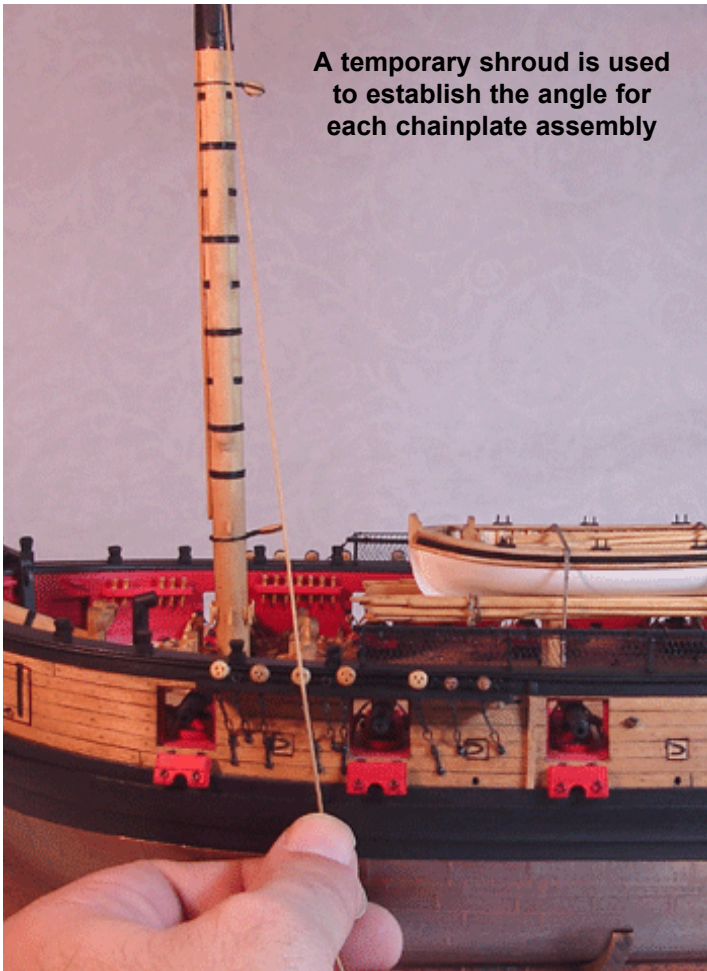

**A temporary shroud is used to establish the angle for each chainplate assembly**

long length of rigging line around the mast head which will produce two loose ends. The loose ends will become the pair of shrouds. Each pair of shrouds is alternated port and starboard. Place one pair on the starboard side first and then the next pair on the port side etc. Do this until you are left with only one shroud to be rigged on either side of the model. This last shroud should be rigged as a single since a pair of shrouds is not required.

The first pair of shrouds should be set up at the forward side of the main channels. The shrouds are set up with a 3.5 mm deadeye rigged onto its end (“turned in”). A lanyard is reeved through this deadeye and its corresponding partner on the channel. The lower shrouds of the main mast will be rigged with .028 black rigging line. Note the orientation of the holes for these deadeyes. They are shown on the plans.

Examine the photos and illustrations provided that explains how to seize a deadeye to the end of each shroud. The deadeyes are seized onto the end of the shrouds as shown. The spacing between the deadeye on the channel and its partner on the shroud should be consistent across the entire channel. To achieve this, a “deadeye claw” can be used as shown in that same illustration. Another method would be to use an alligator clip as shown in the photo. Slowly adjust the deadeye as held by the clip until you are satisfied. Then set up the first seizing just above the deadeye while it is still being held in position by the

alligator clip. Set up each shroud pair completely on the channel with its lanyard before moving to the opposite side of the hull to set up the next pair. Use the .008 tan rigging line to rig your lanyards.

*NOTE: Don't pull the shrouds too tightly when setting them up with the lanyards. You don't want to pull the masts out of alignment. Only apply enough tension so the shrouds are not slack, but not so much that they are pulled too much port or starboard.*

**Main stay** (.040 blk) — With the lower shrouds completed for the main mast, the main stay can be rigged. Start by seizing an eye onto one end of the rigging line. The stay will be placed around the mast head on top of the shroud gang. It will be set up with a mouse under the top as shown in the photos provided. The mouse acts as a stopper so the eye of the stay doesn't slip. Several methods are shown that describe how a mouse can be made. Depending on your experience level, choose the method that you are most comfortable with.

The mouse on the prototype was created using polymer clay. A small bead of clay was pushed onto 22 gauge wire and roughly shaped. Don't make the mouse too large. Use the plans as a guide to approximate its size and shape. The polymer clay hardens after you bake it in the oven for several minutes. Read the directions for the appropriate baking times. There are many brands of polymer clay available and Model Expo can supply them should you choose to use this technique. When you remove the mouse from the oven it can be cut, filed and sanded to more accurately depict the desired shape. A photo provided shows the mouse used on the prototype model prior to being shaped and after. Note the small grooves filed into it which simulate the fine weave of an actual mouse. Paint the mouse black afterwards but you may want to wipe off much of it to show the weave pattern created.

With the main stay set up around the mast you can secure the loose end as shown on the plans. The loose end has a laser cut heart seized to it. Shape the heart as you did the others earlier in this project. A lanyard is reeved between this heart and the one rigged on the foremast. Use .012 tan rigging line for the lanyard.

**Main preventer stay** (.028 blk) — Set up this stay just like the main stay with a mouse. The loose end of the preventer stay also has a heart seized to it. Only this time it will be lashed to another heart that is secured to the deck with an eyebolt. An easy way to do this would be to seize the heart to the eyebolt first. Then drill the hole on deck (starboard side at the bow). The hole should actually be drilled into the margin plank at the bow. See the photos provided that show the two stays completed. Then glue the eye bolt with the heart into that pre-drilled hole. Set up the lanyard between them using .012 tan rigging line.

**Fore mast lower pendants** (.021 blk) — same as the main mast pendants.



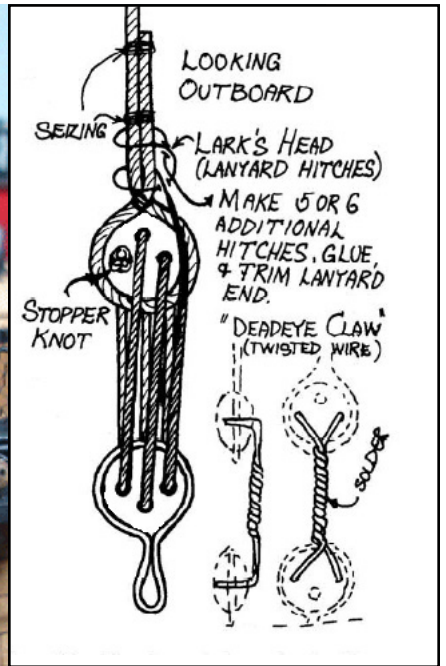

SIMPLIFIED MOUSE FOR STAYS

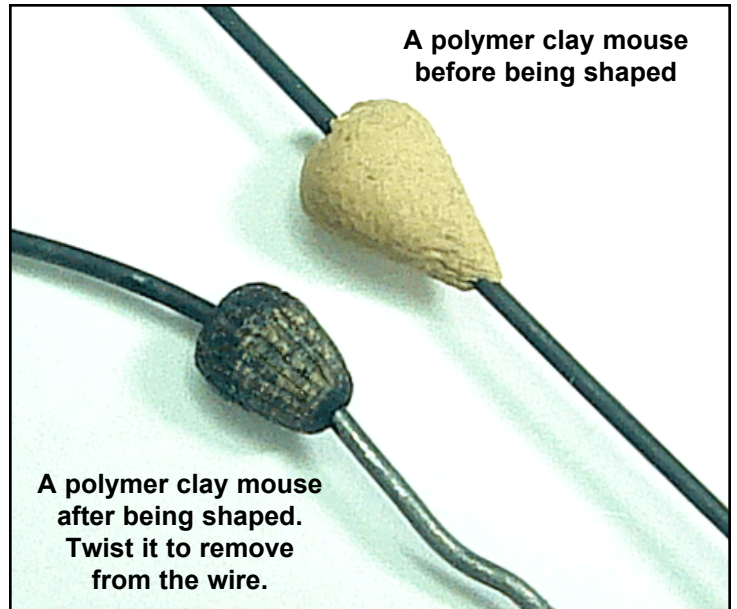
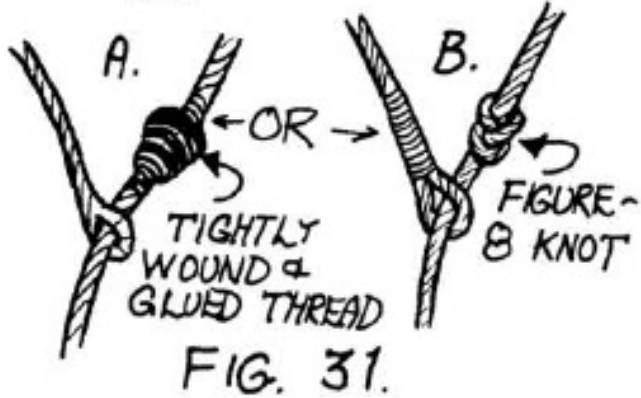

A polymer clay mouse before being shaped

A polymer clay mouse after being shaped. Twist it to remove from the wire.

A MORE ELABORATE MOUSE

FIG. 32.

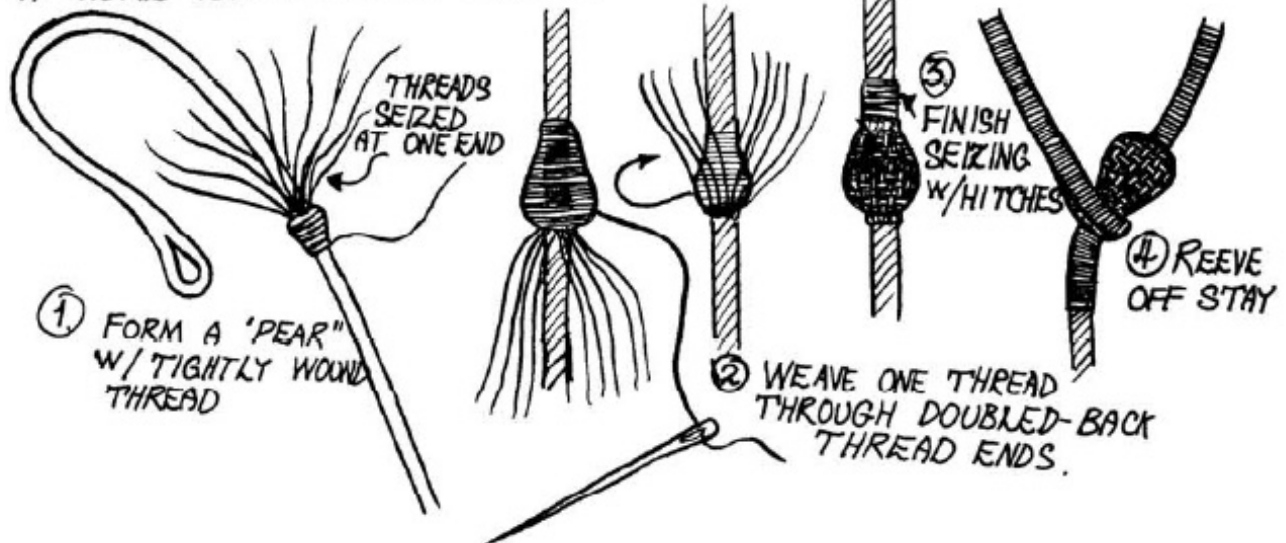



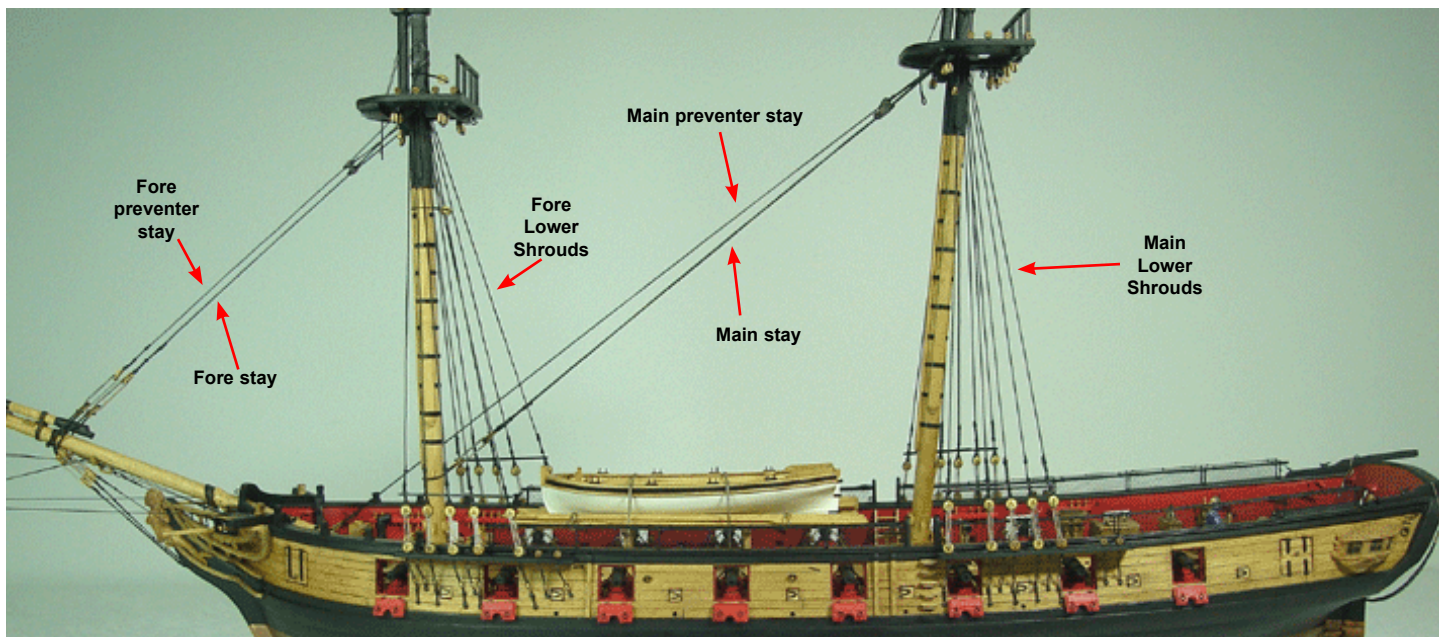

**Fore mast lower shrouds** (.028 blk) — Rig them the same as you did for the lower shrouds on the main mast. Use 3.5 mm deadeyes etc.

**Fore stay** (.040 blk) — Set it up with a mouse as you did for the main stay. Seize a laser cut heart onto the loose end and lash it to the open heart on the bowsprit. See the photo provided. Use .012 tan rigging line for the lanyard. When making the mouse for the fore stays they should be smaller than those used on the main stays. Try not to make them too large.

**Fore preventer stay** (.028 blk) — Same as the fore stay but secure it with a lanyard to the remaining open heart on the bowsprit. Examine the rigging plans carefully.

**Sheer poles and futtock staves** (1/32" x 1/32") — To prepare the shrouds in order to rig the ratlines, the sheer

poles and futtock staves should be lashed to them first. Cut the wood strips to length for the sheer poles. The sheer poles should be lashed to the lower shrouds just above the deadeyes. They were used to prevent the shrouds and deadeyes from twisting. They will serve the same purpose on our model. Lash the sheer poles to the first and last shrouds with some black sewing thread. Apply some glue to the lashings. But before doing so, be sure to adjust the position of the shrouds and make sure all of the deadeyes are not twisted. Then finish it off by lashing the remaining shrouds to the sheer pole. Paint them black afterwards.

The futtock staves are completed in a similar fashion. They are shown under the tops and are also lashed to the shrouds. See the photo provided and the plans for details. The futtock staff is placed about 3/32" above the second iron band on the lower masts. Take the measurements from the plans before gluing them into position permanent-

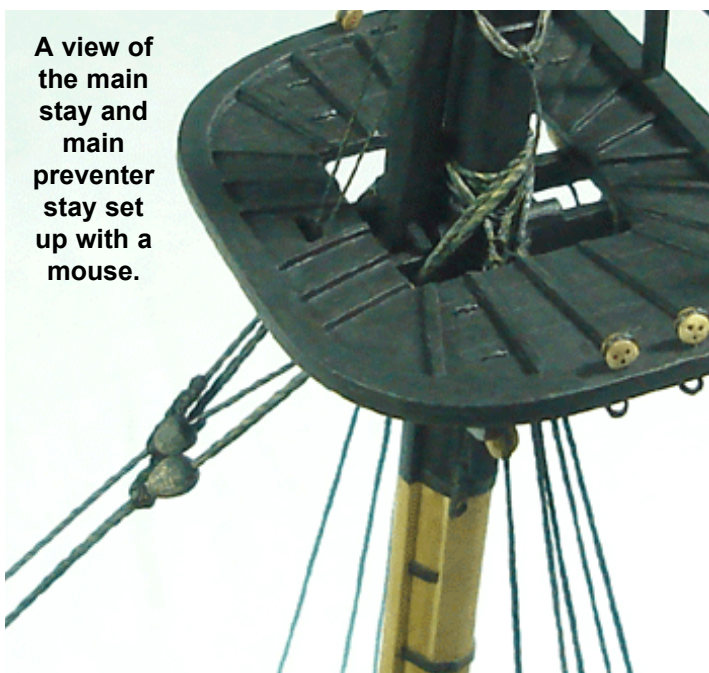

A view of the main stay and main preventer stay set up with a mouse.

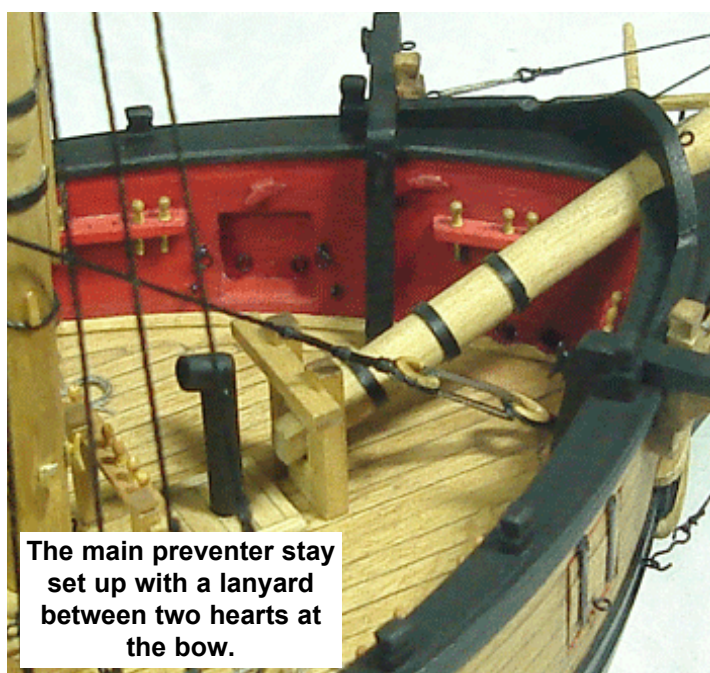

The main preventer stay set up with a lanyard between two hearts at the bow.



Another view of the main stay (.040 black rigging line) and main preventer stay (.028 blk) set up with lanyards and hearts.

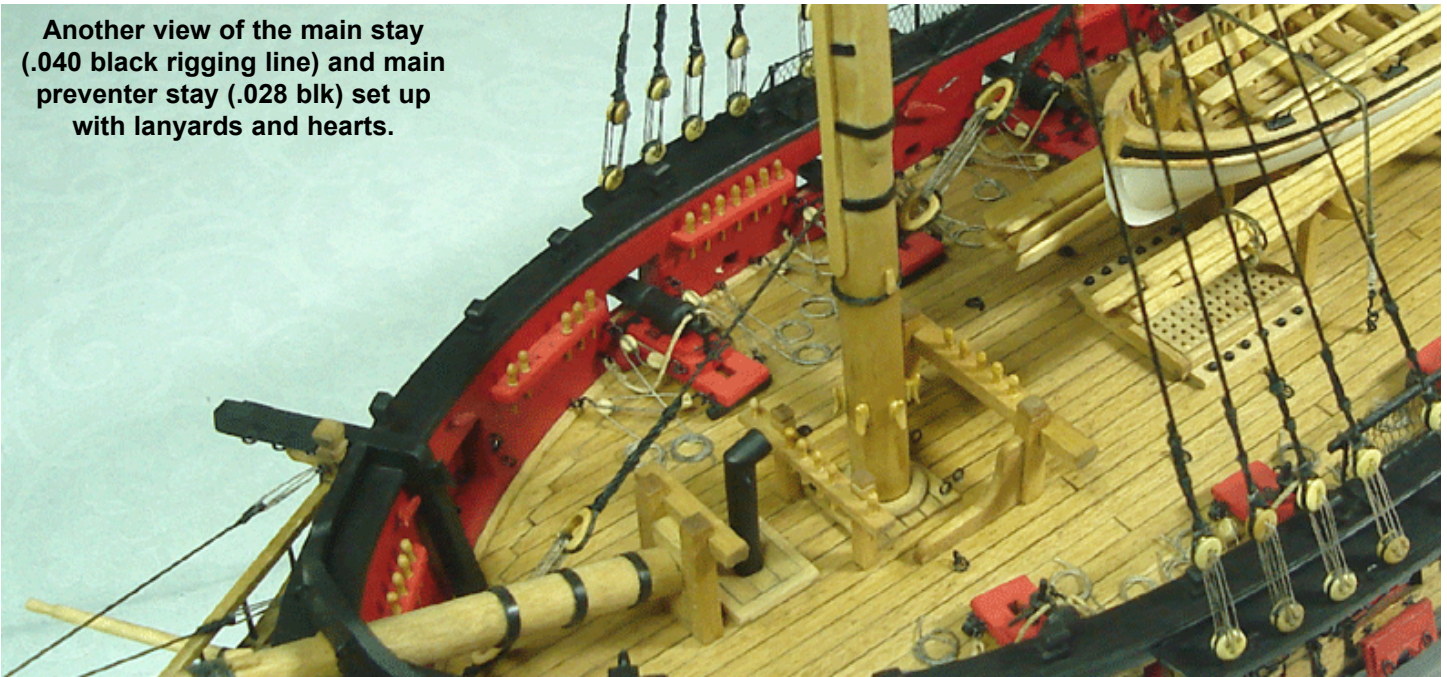

ly. This should give you an idea of how far down on the shrouds the futtock staves need to be positioned.

**Futtock shrouds** (.021 blk) — Seize a hook to the end of the rigging line for each futtock shroud. The hook can be made from 28 gauge black wire. Place the hook into the eye of the futtock plates under the top. Then take the loose end of each shroud and wrap it once around the futtock stave as shown in the drawing provided. Lash the loose end to the lower shrouds below the stave. Touch up the lines with some black paint to remove any shiny spots left by the glue. Lash the four futtock shrouds to the four aft-most lower shrouds.

**Lower Catharpins** (.018 blk) — A pair of catharpins is rigged between the shrouds aft of each mast. The

catharpins are rigged from futtock stave to futtock stave. The plans show them as they were actually rigged on the Syren but depending on your experience you may opt for a simpler approach. On the model prototype each catharpin was simply seized to one futtock stave and then taken across to the opposite stave. The loose end was then seized to opposite futtock stave after establishing the correct tension. The catharpins pull the shrouds together port and starboard. The aft most shrouds have a tendency to spread wider apart than those forward. On our model, the catharpins are used to pull the aftmost shrouds inward to even them out. See the photo provided.

**Ratlines for the lower shrouds** (.008 blk) — Rigging the ratlines can become a tedious and repetitive undertaking. Rather than wait for all of the shrouds on the model to be

Fore preventer stay set up with hearts (.028 blk)

Fore stay set up with hearts (.040 blk)

Sheer pole 1/32" x 1/32"

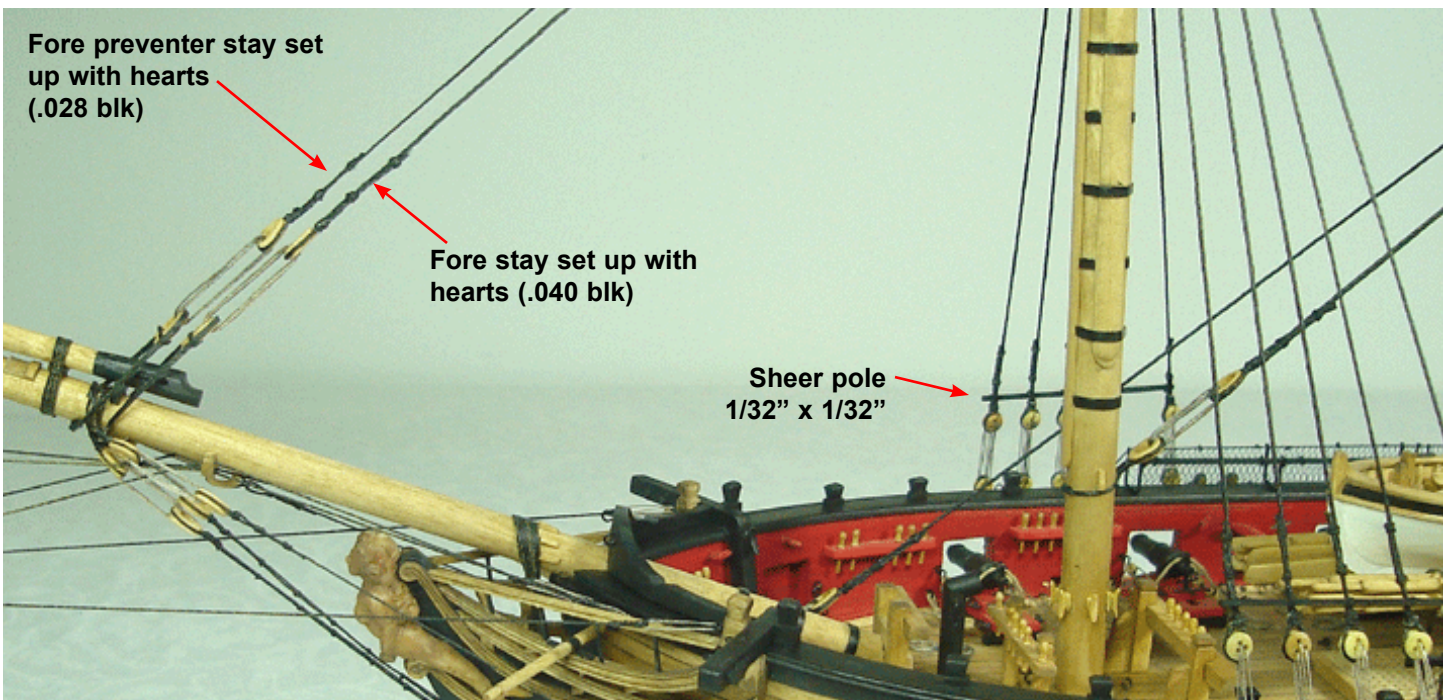



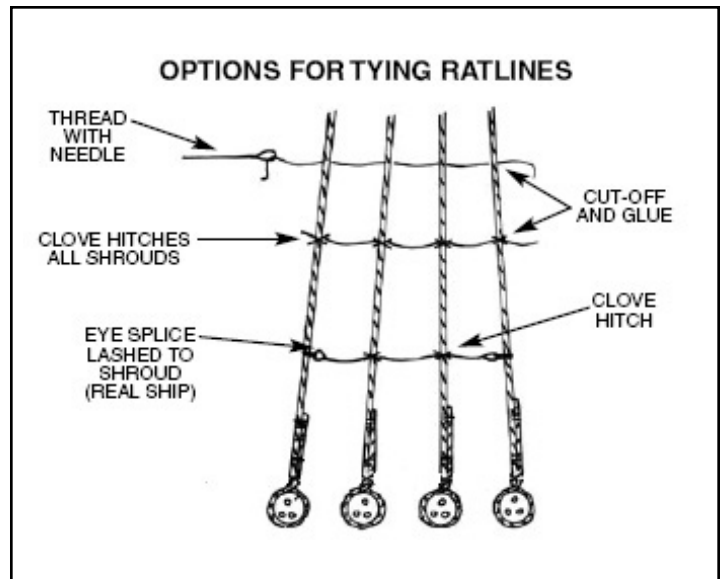
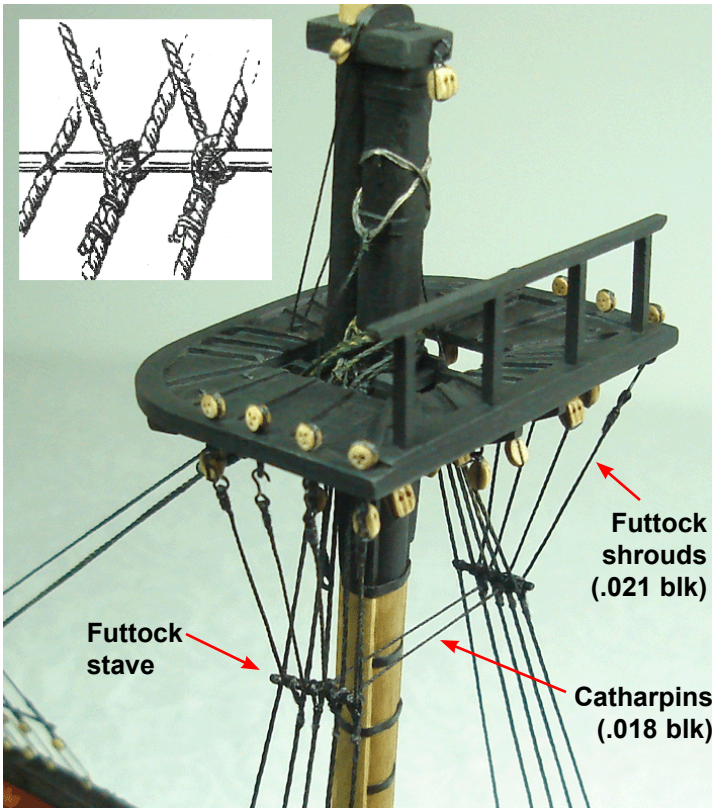

board. Seize a 2.5 mm deadeye onto the end of each shroud and set them up with lanyards to their partners in the top. Remember to keep the distances between the deadeyes consistent and check the orientation of the deadeye holes prior to gluing.

**Main topmast sheer poles and futtock staves** (1/32" x 1/32") — Same as the lower shrouds.

**Sister Blocks above the futtock staves** (3/32 single) — Glue two 3/32" single blocks together, end-to-end. Glue them between the forward-most topmast shrouds. Then lash them to the shrouds with some sewing thread as shown in the photo provided. They are placed just above the futtock stave on the port and starboard sides.

**Cleats** (5mm) — Glue a 5 mm cleat to the inside of each topmast shroud. They are placed just above the sheer poles. The glue is there only to hold them in position so you can lash them to each shroud with some sewing thread. Each cleat was thinned down before being lashed to the shrouds. They are a little thick as supplied with the kit and can be shaped appropriately with some sandpaper. Paint the cleats black when you are finished.

**Upper Catharpins** (.018 blk) — Same as the lower catharpins but this time there is only one.

**Ratlines for main topmast shrouds** (.008 blk) — It is better to rig them now before the backstays get in your way. They are rigged 1/4" apart like the lower shrouds.

**Main Topmast backstays** (.021 blk) — There is a pair of backstays on each side (port and starboard). They are seized around the topmast head like the shrouds. A 2.5 mm deadeye is turned into the bottom of each backstay. They are set up with a lanyard between their partner deadeyes on the channels. These are the smaller deadeyes on the aft end of the main channels. They are spaced the same distance apart as the deadeyes for the lower shrouds.

completed, it might be a good time to start "rattling down" the lower shrouds. The ratlines were usually placed 13" to 16" apart in actual practice. For the model prototype, the ratlines were spaced 1/4" apart or 15 scale inches. Refer to the diagram provided which shows several methods for tying ratlines. The ratlines for the prototype were tied using clove hitches on all of the shrouds. Start tying them 1/4" above the sheer pole and work your way with each new row until you get to the futtock stave. Apply a drop of glue to each clove hitch but adjust them first to ensure each row remains level and straight.

Be careful not to pull the shrouds inward as you work your way toward the futtock stave. To avoid this don't tie your ratlines too tightly. Instead, leave them slack between the shrouds. The ratlines should lay with a natural swag between each pair of shrouds. This is sometimes difficult to achieve on a scale model. Gravity isn't sufficient to establish such a natural swag in the .008 rigging line. Applying some diluted white glue to your ratlines may help establish this natural hanging effect. However, you may have to coax each row of ratlines into shape before the glue dries.

The ratlines can also be completed for the futtock shrouds before moving ahead. They are also spaced a 1/4" apart.

**Main topmast pendants** (.018 blk) - Same as the lower pendants. Place one on each side of the topmast head.

**Main topmast shrouds** (.021 blk) - The main topmast shrouds are rigged just like the lower shrouds. There are two pairs on each side, alternate the pairs port and star-



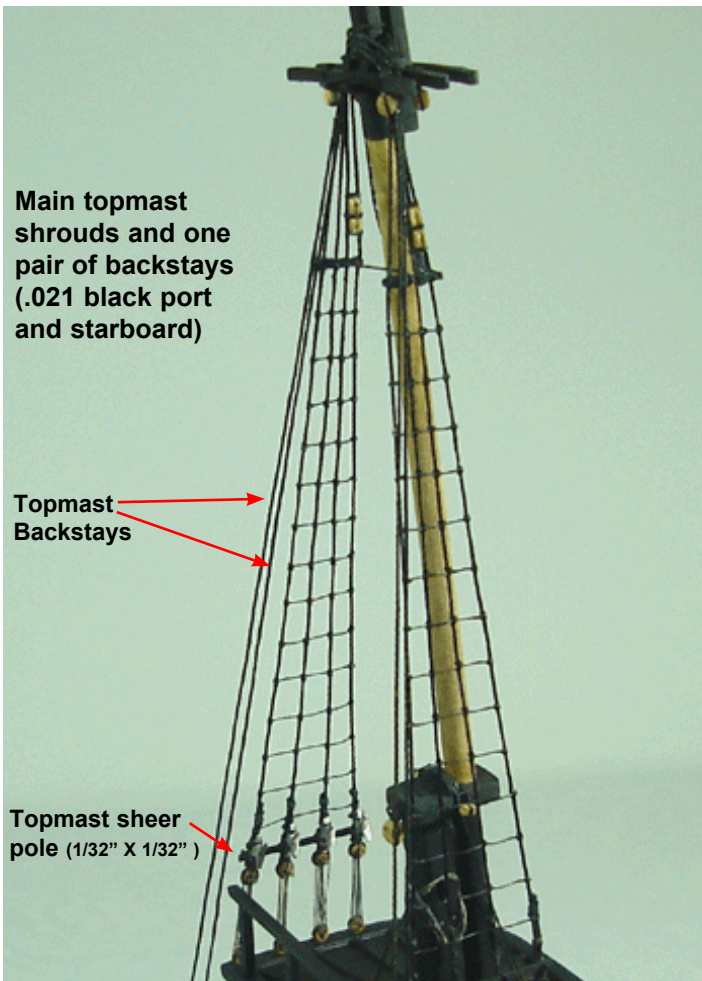

**Main topmast shrouds and one pair of backstays (.021 black port and starboard)**

**Topmast Backstays**

**Topmast sheer pole (1/32" X 1/32" )**

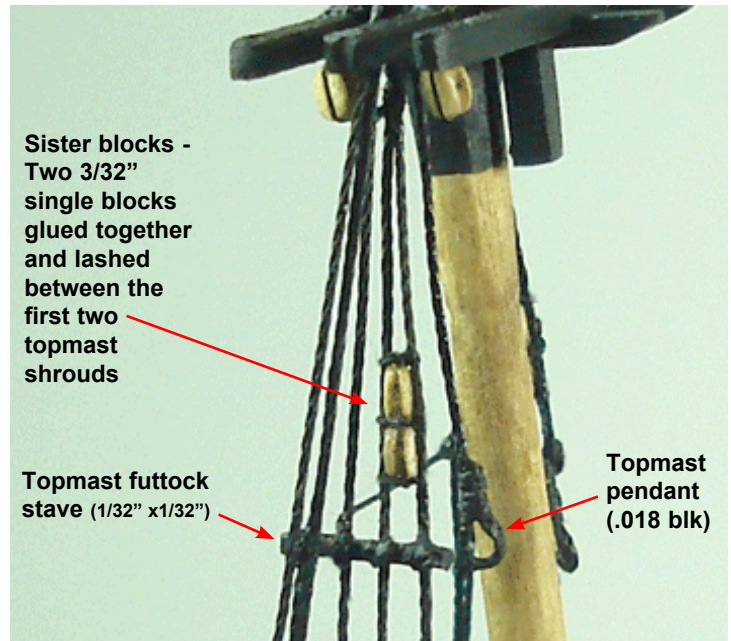

**Sister blocks - Two 3/32" single blocks glued together and lashed between the first two topmast shrouds**

**Topmast futtock stave (1/32" x1/32")**

**Topmast pendant (.018 blk)**

(main topgallant and main royal) are set up in the fore top. It will be easier to rig these two stays in particular without worrying about the fore topmast shrouds and backstays getting in the way. You might also notice in the pictures provided that a temporary stay was run from the bowsprit to the foremast. It is only secured with an alligator clip. When you start progress on the main topgallant rigging (especially the stays) it will no doubt pull the foremast out of alignment. The fore topgallant mast and pole is quite fragile and would bend back under the tension of those stays. The temporary stay was used to create opposing tension on the foremast. This will keep the foremast and pole from bending or even breaking under the tension.

**Main topmast stay** (.028 blk) — This stay is set up with a mouse like the lower stays. Use a generous length of rigging line. It also sits on top of the shroud gang and the trestle trees. The loose end is reeved through the single block rigged to the fore mast beneath the catharpins. Once through this block you can create an eye on the end of the stay. Be sure to test its length before you stiffen it with super glue. The stiffened eye will simulate a thimble. Examine the belaying plan to see how this stay is set up with a lanyard abaft the fore mast. A photo is also provided. Run the lanyard through the eye of the stay and the eyebolt glued on deck. This is the eye bolt closest to the foremast on the port side.

**Main topmast preventer stay** (.021 blk) — Set it up with a mouse around the main topmast head like the topmast stay. Then take the loose end and reeve it through the single block rigged to the fore mast. This is the block that is rigged in the fore top. Take it through the fore top and behind the catharpins. Set it up with a lanyard to the eyebolt on the starboard side just like the main topmast stay on deck. All of these rigging elements are shown on the standing rigging plan and belaying plan. Keep them close by while working on the model.

Note: You might have thought that the fore topmast shrouds and stays would be rigged next. This is not the case. It will actually be easier to complete all of the rigging on the main mast first. Many of the remaining stays

**Main topgallant shrouds** (.018 blk) — There are three topgallant shrouds on each side of the hull. These

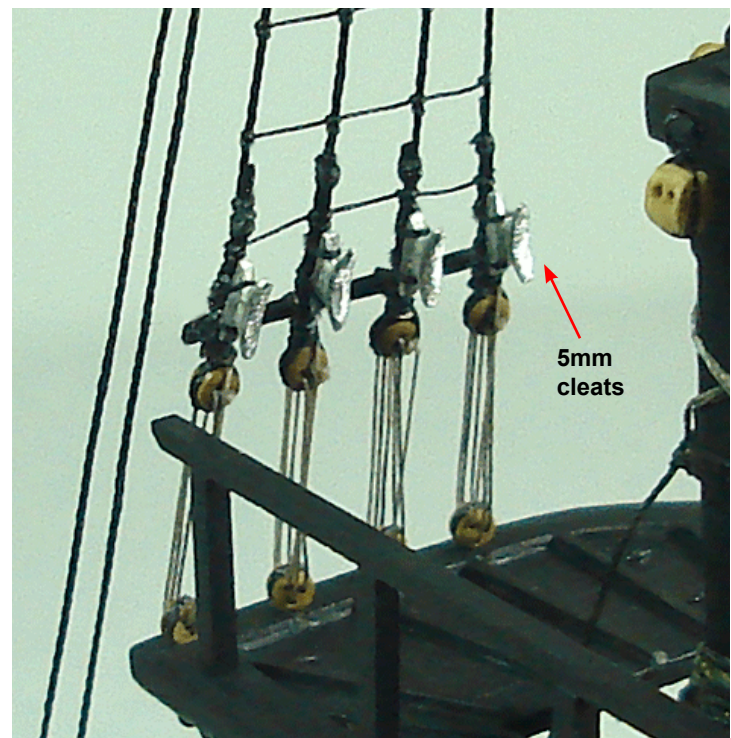

**5mm cleats**



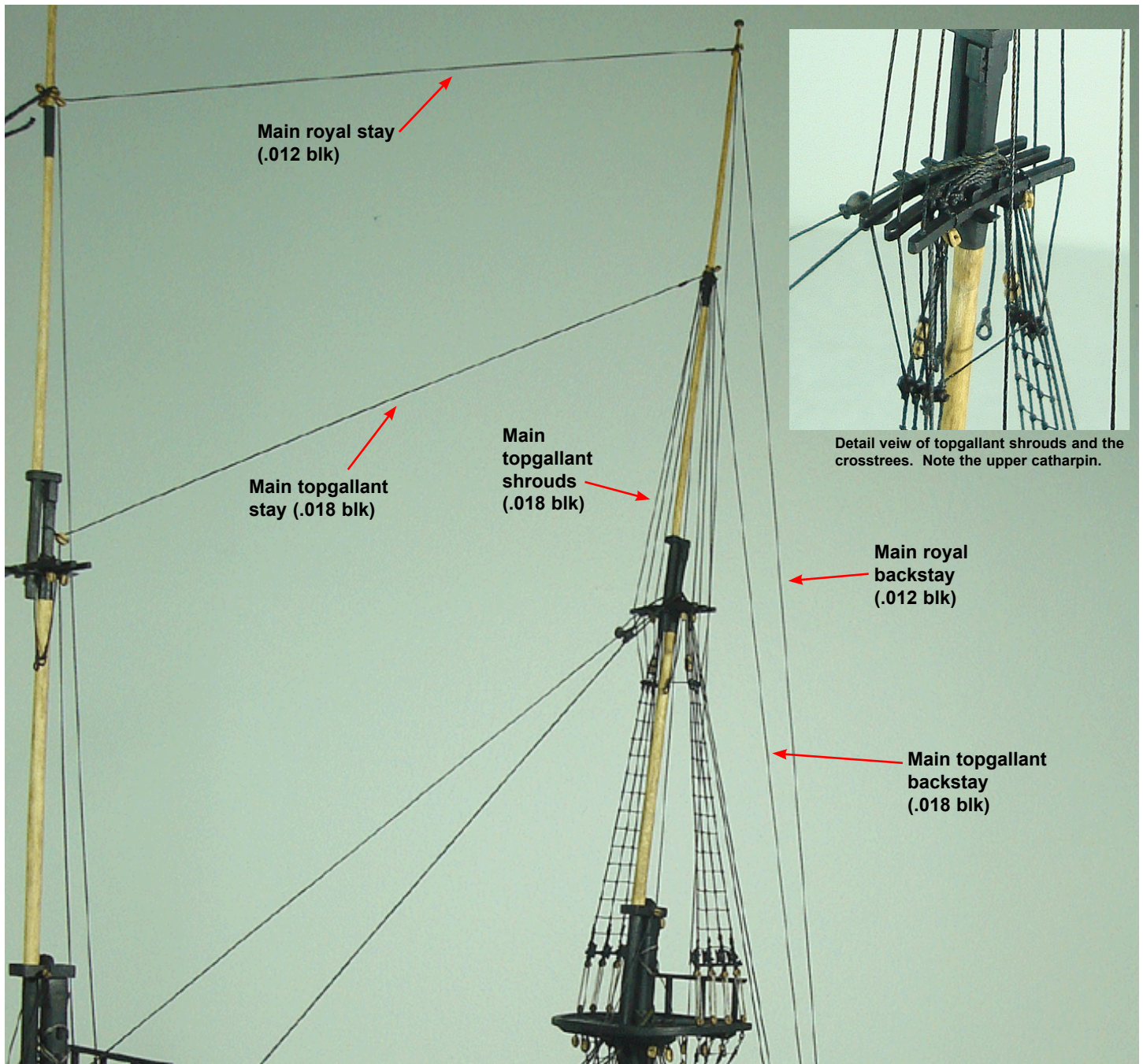

shrouds are also rigged in pairs and you should alternate them port and starboard. There will be two pairs on each side. The only difference here would be that the aft-most pair of shrouds will also be used for topgallant backstays. So when you are seizing that last pair around the main topgallant mast, remember to leave the aft-most leg of that pair extra long. The topgallant backstay will have to reach the main channel where it will be set up to an eyebolt. Examine the rigging plans for details.

The topgallant shrouds have their loose ends reeved through the hole on the ends of the crossrees. From here you can wrap them around the topmast futtock stave and lash them to the topmast shrouds. This is done the same way as the futtock shrouds under the main top. Lash the topgallant shrouds to the three aftmost topmast shrouds. See the photos provided.

**Main topgallant backstays (.018 blk)** — created from the last leg of the aftmost pair of topgallant shrouds. Create an eye on the end of the backstay. Stiffen it with super glue (CA). The backstay is set up with a lanyard to an eye bolt on the main channel. Check the standing rigging plan for the location of that eye bolt. Don't apply too much tension with the lanyard. You don't want to bend or break the topgallant mast.

**NOTE:** This would be a good time to set up that temporary stay from the bowsprit to the foremast as shown in the photo on the page 102. You will need some opposing tension on the foremast before you rig the main topgallant stay.

**Main topgallant stay (.018 blk)** - This stay does not have



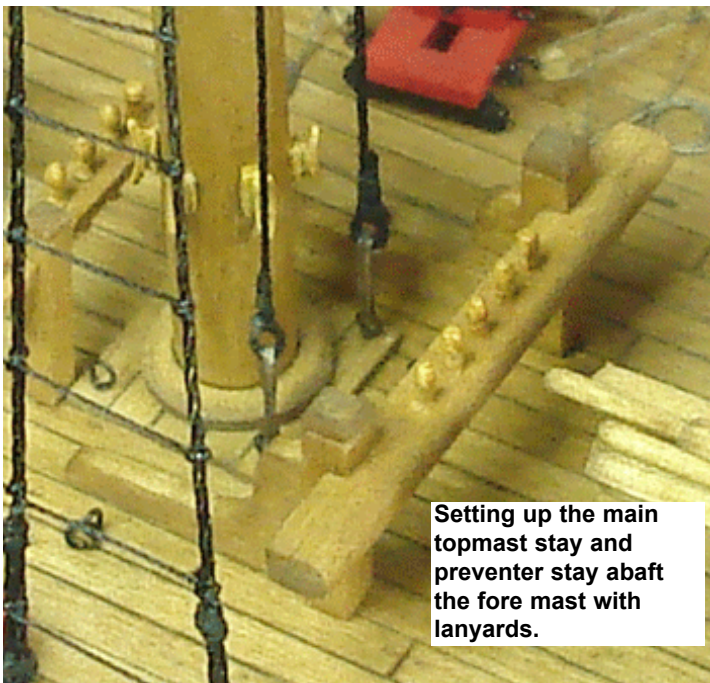

**Setting up the main topmast stay and preventer stay abaft the fore mast with lanyards.**

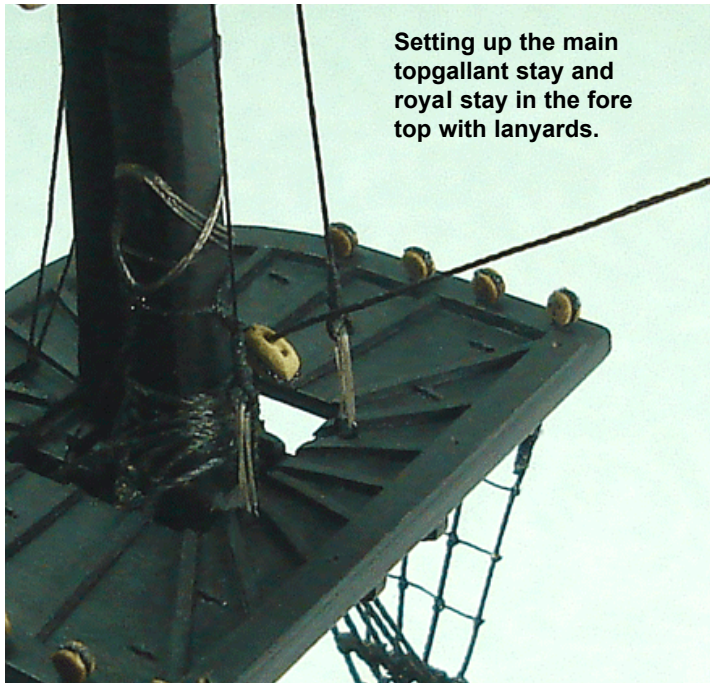

**Setting up the main topgallant stay and royal stay in the fore top with lanyards.**

a mouse. It is simply seized around the main topgallant mast. From here you can reeve it through the 1/8" single block rigged to the foremast. It is the single block located just above the fore trestle trees. Check the plans for details. Once you run it through that block, form an eye on the loose end of the stay. Confirm the length of the stay before you stiffen it with CA glue. The stay will be set up in the fore top to the eye bolt on the starboard side with a lanyard. It is set up similar to the main stay on deck. See the photo provided. This is the reason why I recommended you not glue the railing onto the fore top permanently. You should remove that railing so it will be easier to set up the stay in the top.

alignment. Belay the running end to the pin rail beside the tackle and finish it off with a rope coil.

**Main royal backstays** (.012 blk) - There is one royal backstay on each side (port and starboard). You can seize them around the royal pole as one pair. One leg will be set up to port and the other to starboard. Examine the plans for details. The belaying plan shows how a running tackle is set up on the ends of each royal backstay. Seize a 1/8" double block to the end of each stay. Then prepare a 1/8" single block with a small hook. The hook can be made out of 28 gauge black wire. Seize a generous length of .008 tan rigging line to that single block also. This will be used to create the tackle between the double block on the backstay. You should actually set up that tackle ahead of time. Reeve the tan line through the double block and then back through the single block, etc to create the tackle. When you are finished you should actually have a working block and tackle.

**Main royal stay** (.012 blk) — This stay will also NOT have a mouse. Simply seize it around the main royal pole. Check the plans for its location. From here you can reeve it through the single block rigged to the fore topgallant mast. Once through the block you can create a "stiff" eye on the end of the stay. Set it up with a lanyard in the fore top like the main topgallant stay. Only this time it will be to the

Hook the single block to the eyebolt on the bulwarks. Find its location on the belaying plan. Then pull the running end of the tackle to tighten it up. Apply a drop of glue to one of the blocks so the tackle remains tight. It will no longer be a working tackle. So remember not to over tighten that tackle which would apply too much tension to the mast which could possibly bend or break it. Don't pull the mast out of

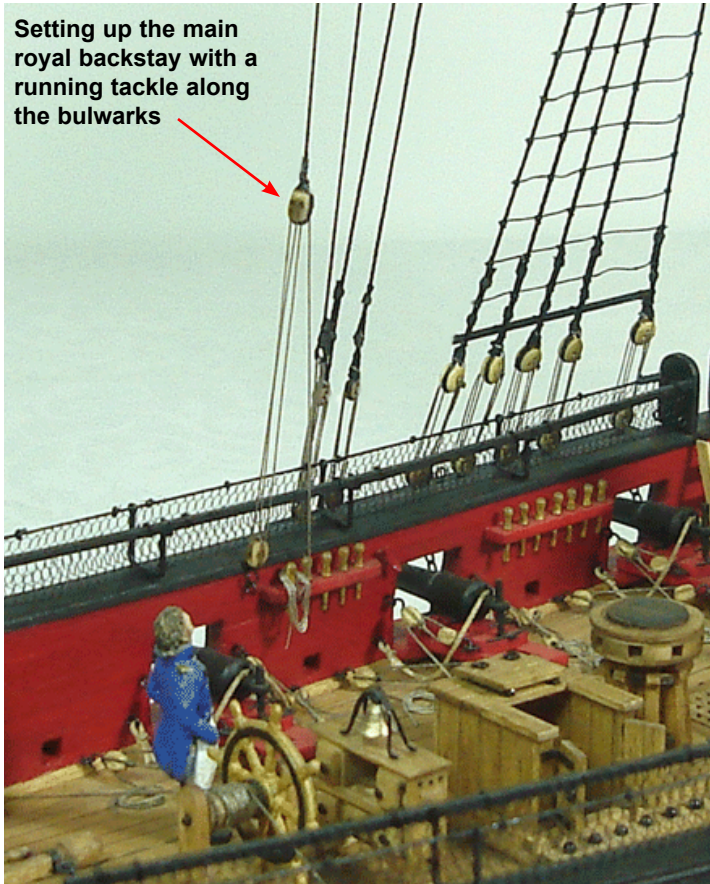

**Setting up the main royal backstay with a running tackle along the bulwarks**



eyebolt on the port side. It is crucial that you apply the correct amount of tension to that temporary stay when rigging this one. You should avoid pulling the main royal stay so tight that it will bend the foremast back. Only apply enough tension so both masts maintain their correct rake while continuing to stand straight without bending.

**Fore topmast pendants** (.018 blk) - Same as the main topmast pendants. Place one on each side of the topmast head.

**Fore topmast shrouds** (.021 blk) — Same as main topmast shrouds.

**Fore topmast sheer poles and futtock staves** (1/32" x 1/32") — Same as main topmast shrouds.

**Sister Blocks above the futtock staves** (3/32 single) — Same as main topmast shrouds.

**Cleats** (5mm) — Same as the main topmast shrouds.

**Upper Catharpins** (.018 blk) — Same as the main topmast.

**Ratlines for fore topmast shrouds** (.008 blk) — Same as the main topmast shrouds.

**Fore topmast backstays** (.021 blk) — Same as main topmast backstays.

**Fore topmast stay** (.028 blk) — This stay is set up with a mouse like the lower stays. Use a generous length of rigging line. It also sits on top of the shroud gang and the trestle trees. The loose end is reeved through the bees on the port side. Once through bees you can create an eye on the end of the stay. Be sure to test its length before you stiffen it with super glue. The stiffened eye will simulate a thimble. Examine the belaying plan to see how this stay is set up with a lanyard at the bow. This stay is set up to the eyebolt at the bow. It's a little tricky to rig, but if you make the lanyard very long and use a tweezers to reeve it through the eye bolt and stay carefully you shouldn't have any problems. Before you start make sure the eyebolt is very secure in the bow. Reset it with glue beforehand if it is loose. You don't want it to pull free while setting up the lanyard.

**Fore topmast preventer stay** (.021 blk) — Set it up with a mouse around the fore topmast head like the topmast stay. Then take the loose end and reeve it through the bees on the starboard side. Set it up with an eye and lanyard to the eyebolt on the starboard side of the bow just like the fore topmast stay.

**Fore topgallant shrouds** (.018 blk) — Same as main topgallant shrouds.

**Fore topgallant backstays** (.018 blk) — Same as main topmast backstays.

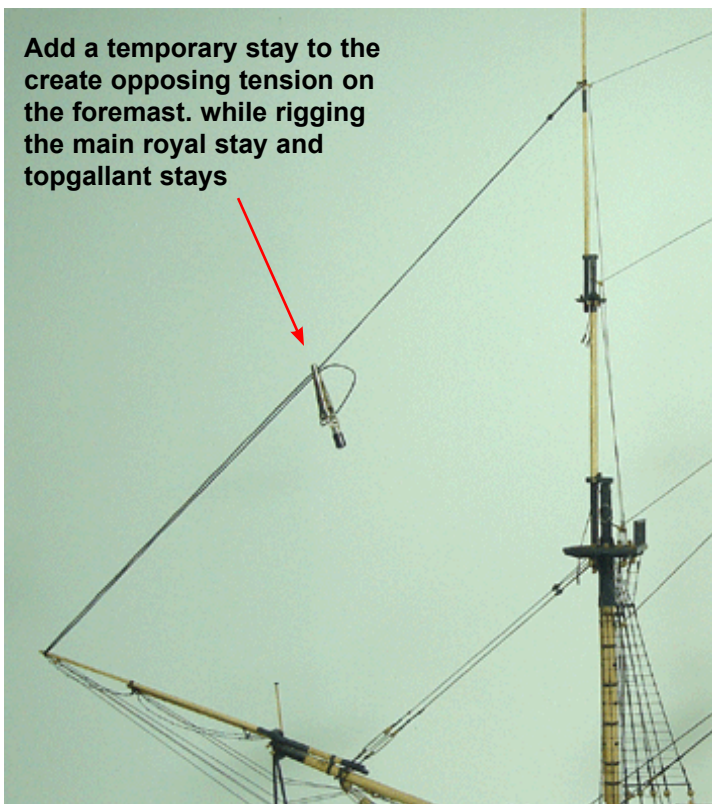

**Fore topgallant stay** (.018 blk) - This stay does not have a mouse. It is simply seized around the fore topgallant mast. From here you can reeve it through the notch (simulated sheave) you made on the tip of the jibboom. Examine the rigging plan for details. From here, take the loose end and run it through the "open" hole left on the dolphin striker (starboard). Then the end is reeved through the unused hole on the fairlead under the bowsprit. To finish it up, create a stiffened eye on the end of the stay and set it up with a lanyard to the remaining eyebolt at the bow.

**Fore royal backstays** (.012 blk) - Same as the main royal backstays. Check the belaying plan for belaying details.

**Fore royal stay** (.012 blk) — This stay will also NOT have a mouse. Simply seize it around the fore royal pole. Check the plans for its location. From here you can reeve it through the groove you made on the tip of the flying jibboom. Examine the rigging plan for details. Then take the loose end and run it through the "open" hole left on the dolphin striker (port). Then the end is reeved through the unused hole on the fairlead under the bowsprit. To finish it up, create a stiffened eye on the end of the stay and set it up with a lanyard to the remaining eyebolt at the bow. (Just like the fore topgallant stay)

**Jib Stay** (.018 blk) - Take a very generous length of rigging line and run it through the cheek block (upper sheave) on the starboard side of the fore topmast head. See the rigging plan for details. Make sure you have a sufficient amount of line to reach the channel and run through the sheave on the jibboom as shown. It is easier to glue the jib stay into the cheek block after you determine the length is



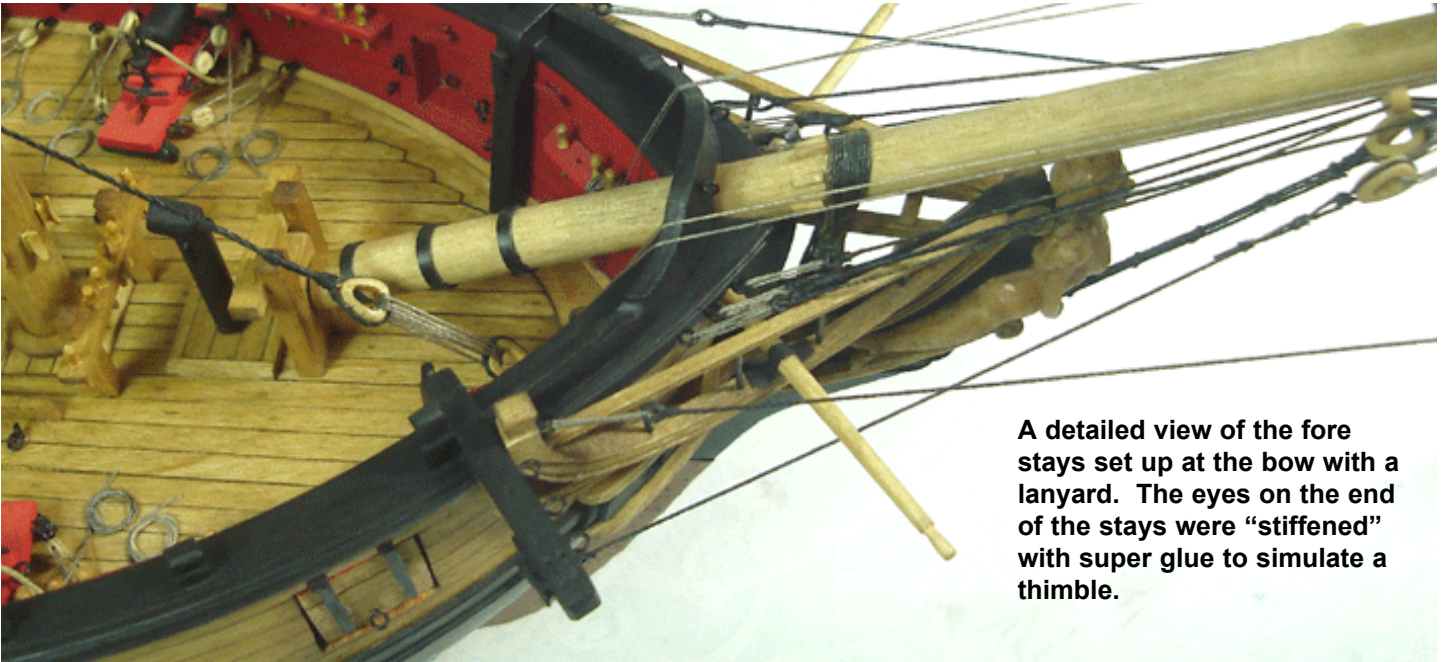

**A detailed view of the fore stays set up at the bow with a lanyard. The eyes on the end of the stays were "stiffened" with super glue to simulate a thimble.**

OK. This will create the appropriate tension to set it up with a stiffened eye and lanyard on the channel. Also see the note provided on the rigging plan. Set up that lanyard on the channel to the appropriate eyebolt. (Similar to how the topgallant back stays were handled)

The other end of the jib stay can be run through the top of traveler on the jibboom. From here it is reeved through the sheave you made through the jibboom. It may be easier to glue the stay permanently in that sheave to create the appropriate tension on the stay. Be careful to position the traveler properly while establishing that tension. The traveler will probably want to slip forward but that's ok. As long as you establish the appropriate tension while holding it in position, the traveler will be stabilized later with an inhaul.

With the jib stay glued into that sheave and stabilized, you

can now seize a 3/32" single block to its end. This block will be used to set up a tackle. The other block for the tackle is the one seized to the bowsprit cap. Use .008 tan rigging for the tackle. The running end of the tackle can be taken inboard at the bow. Belay it to (E). Do not finish it off with a rope coil just yet.

**Inhaul for the jib stay traveler** (.008 tan) - The inhaul can be seized to the side of the traveler (starboard). From here it runs inboard at the bow and is also belayed to (E). The inhaul will pull the traveler tight against the jib stay and create the appropriate tension you desire. See the photo provided. Finish it up with a rope coil on that belaying pin.

**Flying jib stay** (.018 blk) — Is set up similar to the jib stay but this time the stay is simply seized around the topgallant mast head. See the plans for details. Run it through

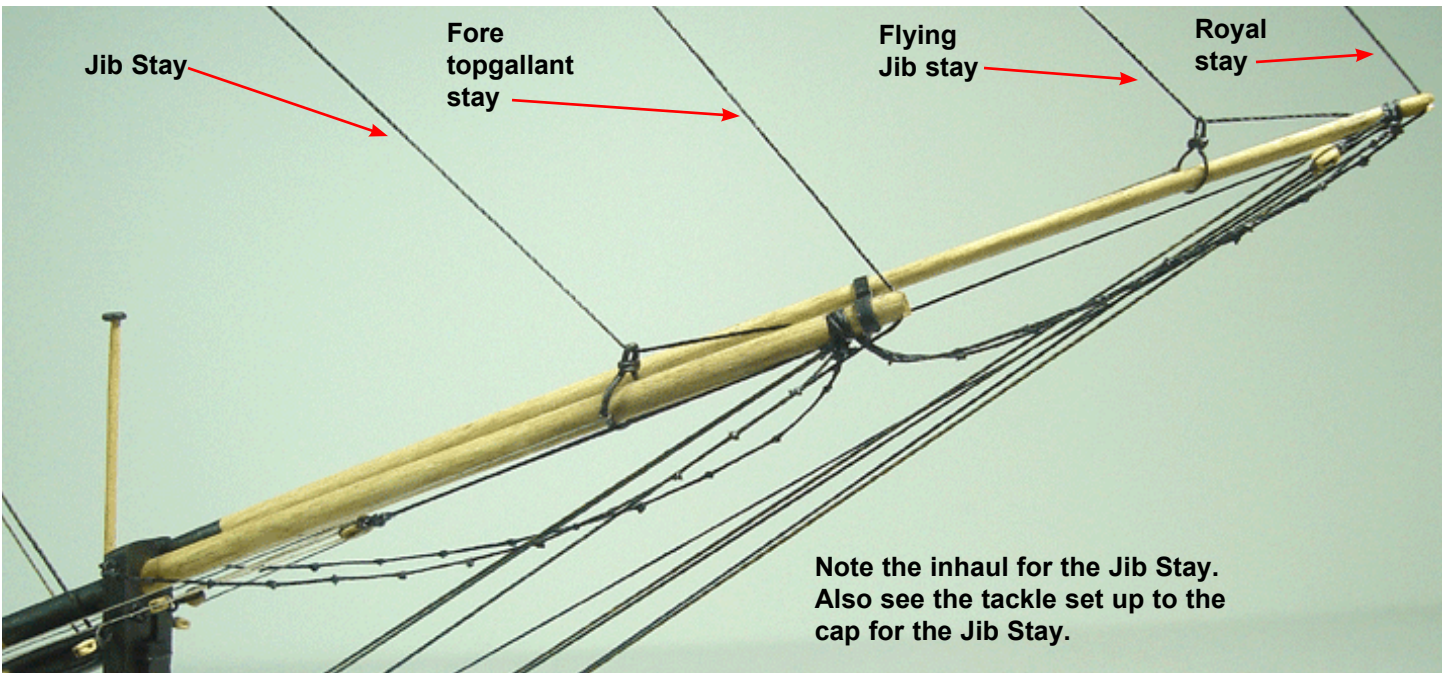

**Note the inhaul for the Jib Stay. Also see the tackle set up to the cap for the Jib Stay.**



the other traveler and then through the sheave on the flying jibboom. Then set it up with a tackle on the port side of the bowsprit cap (use 3/32" single blocks). The running end of the tackle is belayed to (F) inboard.

**Inhaul for the flying jib stay traveler** (.008 tan) - Same as for the jib stay traveler inhaul. It is also belayed to (F). Finish it off with a rope coil.

**Horses** (.018 blk) — The horses are rigged by seizing a line to the eyebolt on the splash guard. The other end is seized to the eyebolt on the bowsprit cap. This is done both port and starboard. Don't make these too taut. Once completed you will take a shorter length of .018 line and seize it to the fore stay. Seize it just above the closed heart. The other end of this "leg" will then be seized to

the horse. Apply enough tension so the horses are pulled upward and taught. When you have the correct tension and spacing established, apply a drop of glue to hold it. Try and make the horses on both sides equally tensioned and angled.

Lash three 1/32" x 1/32" strips/battens across the horses. See the photo provided and the plans for their placement. Try not to pull the horses together. Keep the space between them consistent. Paint these strips black.

To complete this step, cut a small square of netting to fit the space between the aft most battens. Lash the netting securely to the horses and battens. Touch up any shiny areas left by the glue with some black paint.

**A detailed view of the Bowsprit Horse. Note the three "stretching battens" lashed to the horses. Use 1/32" x 1/32" strips for these. Netting is added between the two aft strips once they are painted black.**

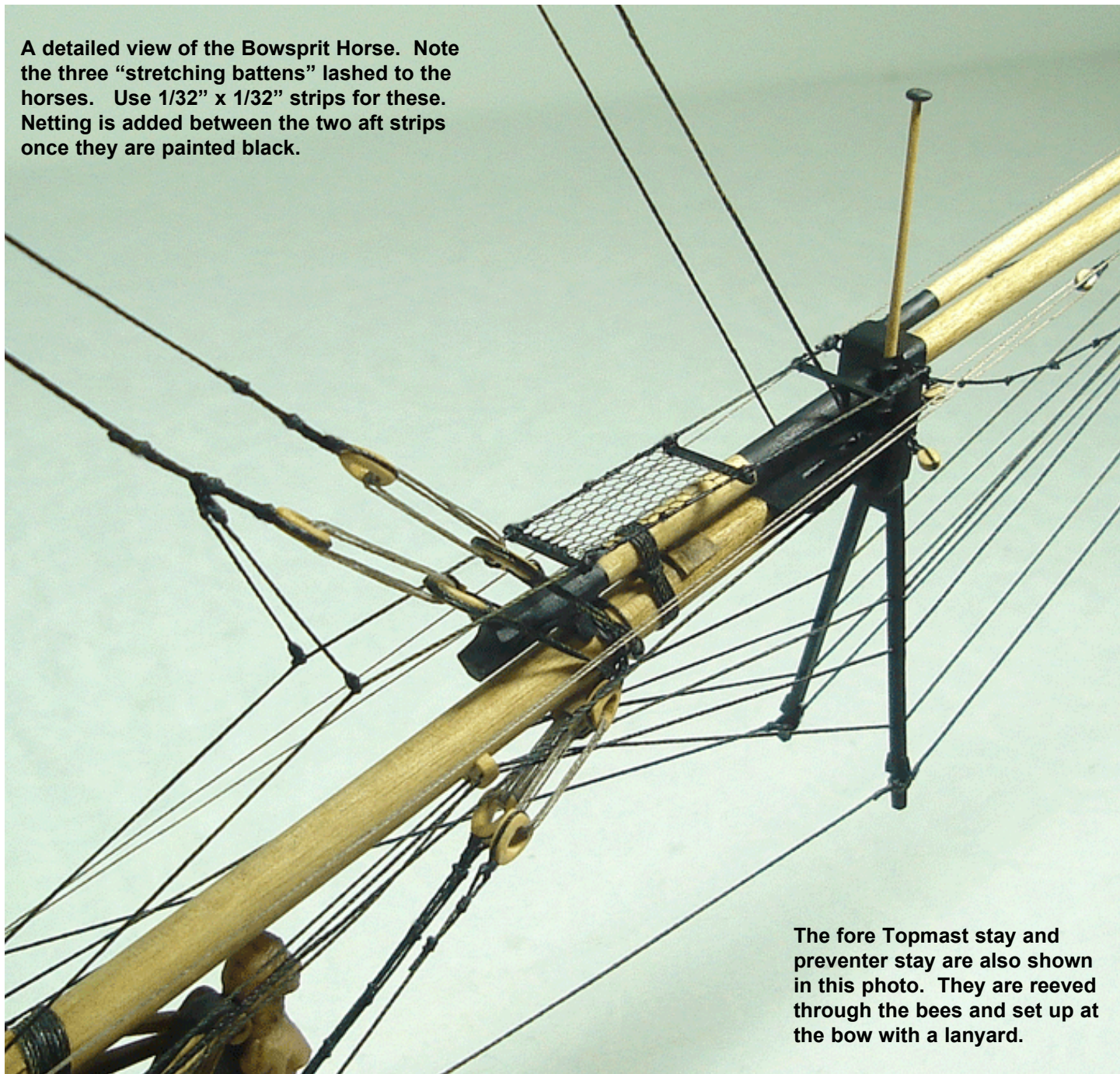

**The fore Topmast stay and preventer stay are also shown in this photo. They are reeved through the bees and set up at the bow with a lanyard.**





## Chapter Nineteen Yard Construction and Running Rigging

### Constructing the Boom and Gaff...

The Boom and Gaff were created and rigged next on the prototype. Use a 5/32" dia. dowel for the boom and a 1/8" dia. dowel for the gaff. Taper them as shown on the plans. The jaws for the boom and gaff have been laser cut for you. Before removing them from the wood sheet it is recommended that you drill the holes on the ends of the jaws first. This will decrease your chances of splitting the wood while drilling them. Round off the edges of the jaws and sand off any burn marks that might be present from the laser cutting. As you taper the boom and gaff you should check periodically to see how the jaws fit. This will help you avoid over tapering them. Glue the jaws into position when you are satisfied.

The iron bands around the boom and gaff jaws are simulated using 1/16" wide black pinstripe tape. Create and attach all of the cleats shown along the boom and gaff. These were made using 1/32" x 1/32" strips. There are also a couple of eye bolts which need to be inserted on the top of the jaws as shown on the plans. At this stage it would be a good time to decide if you will paint all of the spars and yards black for model. This is a subjective decision based on your own personal tastes. You should paint the spars black before you add any blocks.

Examine the running rigging plan which shows the positions for all of the blocks needed on the boom and gaff. Shape them all and rig them ahead of time before you position them on the model permanently. See the photos provided that show the details of the completed boom and gaff assemblies. Note that the guy and vang pendants were also rigged ahead of time.

Lastly the parrels can be added to the boom and gaff jaws in preparation for final rigging. Small beads are supplied that can be strung on the parrel line after seizing it to one of the jaws.

### Rigging the Boom and Gaff...

Once again the process has been written in the order used to rig the prototype model. There are many ways to approach this and you should read through all of these directions thoroughly before starting. See if you would be more comfortable altering this sequence based on your past experiences and sensibilities.

**Throat Halliard for the Gaff** (.008 Tan) — The very first line to rig is the throat halliard. Seize a generous length of line to the 1/8" double block under the main top. Examine the plans carefully for all blocks and belaying points. Once it is seized to that block, simply coil up the halliard and secure it to the shrouds or other safe place. This will ensure that it won't get in the way while you mount the gaff in the next step.

Attach the gaff...to the lower mast by placing it in position under the top (just under the catharpins). Bring the parrel around the mast and seize it to the other jaw end. Test the length of the parrel to see if you have used the appropriate number of beads first. If so, then apply a drop of glue to that seizing to secure the gaff in position permanently. It will probably hand down helplessly for now until we rig the appropriate lines that follow.

Finish rigging the throat halliard at this time. Run it





**Rigging for the Gaff**

through the double block on the gaff jaws. Then repeat the process to complete the tackle through both sheaves of the double block. Take the loose end down to the deck and belay it to (W) along the port side pin rail. Finish it off with a rope coil.

**Gaff Peak Halliard** (.012 tan) — Seize the end of a generous length of line to the tip of the gaff. Run it through the double block on the main cap. Establish the correct angle of the gaff. Once you are satisfied, apply a drop of glue to the line as it runs through the double block to “lock-in” the angle and height of the gaff. From there, take it through the single block seized to the center of the gaff. Then bring the line back up to the double block on the cap and belay the running end to (S) on the fife rail. Remember to take the line through the center of the main top (down the lubber’s hole). Finish it off with a rope coil.

**Gaff Vangs** (.008 tan) — The vangs will be rigged on both the port and starboard sides of the gaff. Seize one end of the vangs to the eye bolt (U) marked on the belaying plan. Take the loose end up through the block on the vang pendant. Bring it back down to the cleat (U) along the bulwarks. Before gluing the end to the cleat make sure that you don’t pull the gaff too much to one side. Be careful to position the gaff along the center line of the hull. Finish it up with a rope coil. Repeat this process on the other side of the hull for the second set of vangs. The flag halliard shown on the plans will be rigged later on the prototype.

Attach the boom to the main mast much like you did for the gaff. Position the boom jaws on the boom rest and secure the parrel around the mast.

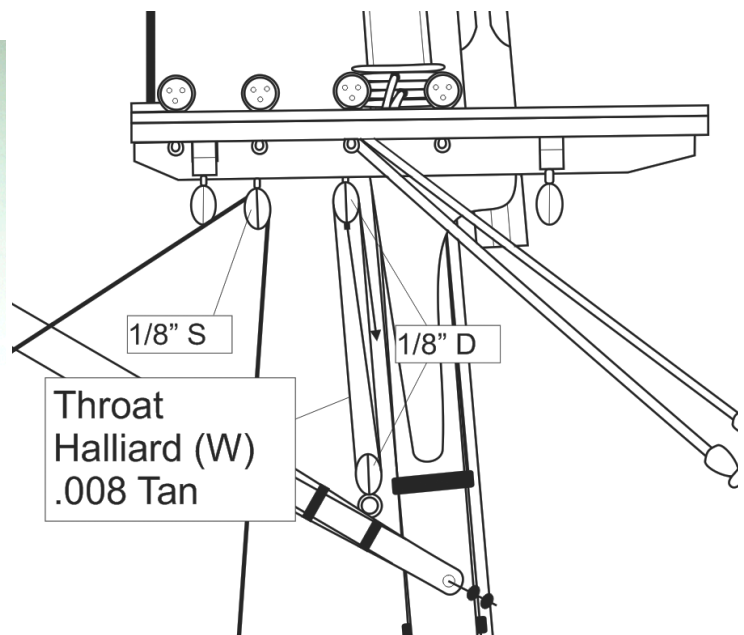





**Boom Topping Lifts** (.012 tan) — There are two topping lifts. One is rigged on the port and on the starboard sides of the hull. Seize the line to the tip of the boom. From here, run it through the single block under the main top. Establish the correct angle and height for the boom. When you are satisfied it can be “locked-in” by applying some glue to the sheave of that block. Seize a 3/32” single block to the loose end of the topping lift. This will create one end of a running tackle. Examine the rigging plans to determine its height off of the deck.

The topping lift halliard will be seized to this block. It will run through another single block (with a hook) to create the tackle. This second block should be hooked to an eye bolt along the main channel. Take the running end of the tackle and belay it to (V) along the bulwarks. Finish it off with a rope coil. Repeat this process for the remaining topping lift on the other side of the hull. Note the “leg” of .008 rigging that runs from the topping lift to the boom. It is shown on the rigging plans. This should be rigged as well.

**Boom Sheet** (.008 tan) — This line is first seized to the double block under the boom. Then it is run through the double block secured to the horse on the stern. Belay the running end to the horse and finish off with a rope coil. See the photo provided.

**Boom Guys** (.008 tan) — Seize a length of tan rigging line to the block on the end of the guy pendants. From here the line is reeved through another single block that is seized to the top of the stern rail. This 3/32” single block is seized to an eye bolt that is glued into the top of the stern. Run it back through the originating block and belay it to the cleat (Y) on the inboard side of the stern. Finish it



off with a rope coil. Repeat the process for the remaining Boom guy on the other side of the hull.

**Foot ropes** - The footropes can be rigged next. Use black .012 rigging line. Examine the rigging plans for details. There is a pair of foot ropes to be rigged with knots placed 1/4” apart along them.

## Staysail rigging...

**Main topmast staysail downhaul** (.012 tan) — Seize a 3/32” single block to the main topmast stay. Examine the plans closely for its position. Then create an eye in the end of the rigging line. This is the eye that will receive the hooked block of the staysail halliard. Run the line through the single block you just secured to the stay. Position the eye an appropriate distance from the foremast. When satisfied, “lock-in” that position by applying a drop of glue to that single block. Take the running end down to the pin rail on the starboard side bulwarks. Belay it to (M). Finish it off with a rope coil. Be sure not to pull the line to tightly while belaying it. You don’t want to pull the stay to starboard. Apply just enough tension so the line doesn’t go slack.

**Main topmast staysail halliard** (.008 tan) — Seize a generous length of line to a 3/32” single block. Then seize that block to the main topmast stay (above the mouse on the port side). Once secured, take the halliard and run it through another 3/32” single block that has a hook in one end. This hooked block should be attached to the eye you formed on the end of the down haul. Take the running end of the halliard back up through the originating block and belay it to (N). This is the pin rail on the port side abaft the



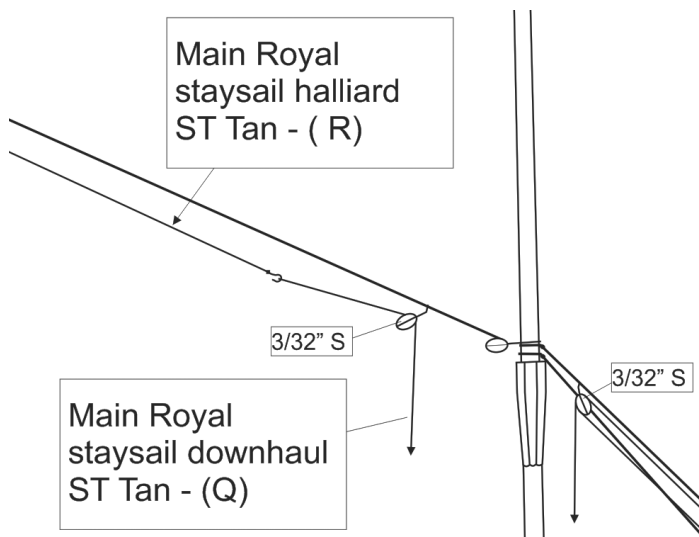
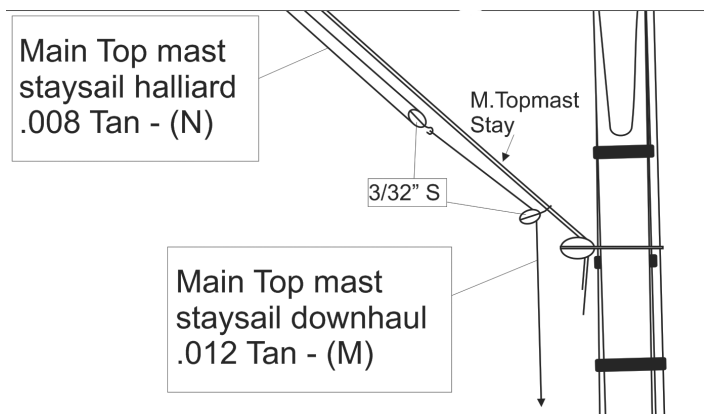

main mast. Be sure to run the halliard through the lubber's hole of the main top first. Finish it off with a rope coil.

**Main topgallant staysail downhaul** (sewing thread or .008 tan) — Set this up just like you did for the previous staysail downhaul. Only this time you will belay the running end to a shroud cleat (O) in the fore top. Check the plans carefully before rigging.

**Main topgallant staysail halliard** (ST or .008 tan) — Same as topmast staysail halliard but belay to a main top shroud cleat (P). Finish off with a rope coil.

**Main Royal staysail downhaul** (ST or .008 tan) - Same as the topgallant staysail down haul.

**Main Royal staysail halliard** (ST or .008 tan) — Similar to the topgallant staysail halliard but this time there is no hooked block. Simply seize a hook to the end of the halliard. Run the halliard through a single block seized to the main royal stay. Then bring it down to the main top where it should be belayed to a shroud cleat (R). Examine the plans for details.

**Fore topmast staysail downhaul** (.008 tan) — Seize a 3/32" single block to the fore topmast stay. Check the rigging plan for its position just above the jibboom. Create an eye in the end of the rigging line. Run the line through the block and establish the distance of the eye from it. Once you are satisfied, "lock-it" in that position by adding a drop of glue to the sheave of that block. Take the running end inboard at the bow and belay it to (I) on the port side pin rail. Finish it off with a rope coil.

**Fore topmast staysail halliard** (.008 tan) — Very similar to the main topmast staysail halliards. Seize a generous length of line to a 3/32" single block. Seize this block to the fore topmast stay (above the mouse) on the starboard side. Run the line through a second single block with a hook. Hook this block into the eye of the downhaul. Run the line back up to the originating block and belay it to a shroud cleat (L). Finish it up with a rope coil.

**Jib sail downhaul** (.008 tan) — Similar to the fore staysail downhaul. This time however, you will seize the 3/32" single block to the traveler on the starboard side. Belay the running end to the pin rail at the bow (H). Add rope coil.

**Jib sail halliard** (.008 tan) — Prepare a 3/32" single block with a hook. Then take the halliard and seize it to the jib stay. Run the loose end through the hooked single block. This block should be hooked into the eye of the downhaul. Take the running end back up to the cheek blocks on the port side of the topmast. Run it through the upper sheave of the cheek block on the port side. Belay it in the fore top to a shroud cleat (K). Add rope coil.

**Flying jib sail downhaul** (sewing thread or .008 tan) — Set this up the same as the jib sail down haul except the single block should be seized to the traveler on the port side. The plan shows it on the starboard side for clarity only. Belay it to the pin rails at the bow (G). Add rope coil.

**Flying jib sail halliard** (ST or .008 tan) — Set this up the same as the fore topmast staysail halliard. Belay it in the fore top to a shroud cleat (J). Add a rope coil.



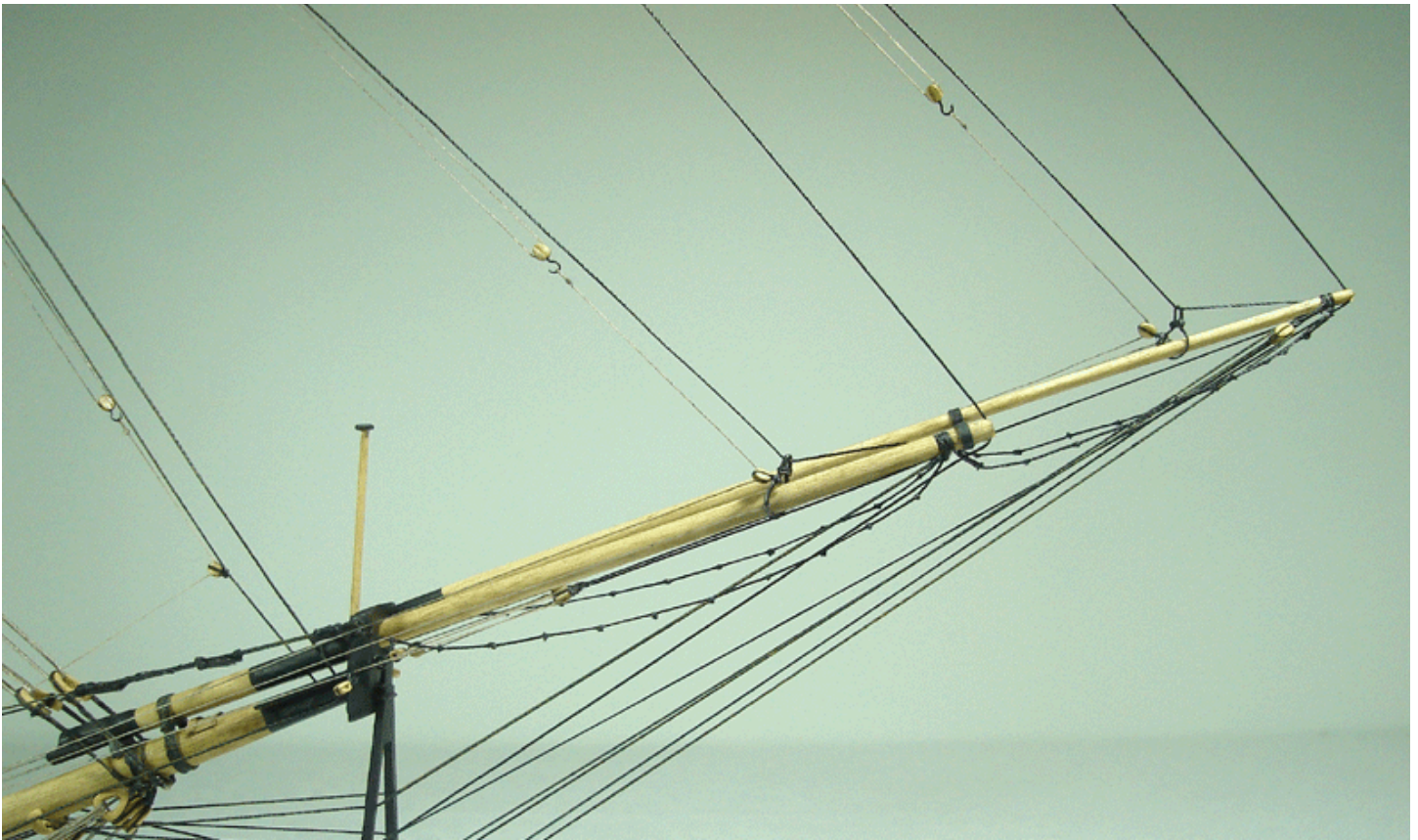

## Constructing the Yards...

### The lower yards (Main and fore mast)

The lower yards will be constructed using a 5/32" diameter dowel. The yards will be identical for the fore and main masts. This will be true for all of the yards made for both masts. Build each pair of yards simultaneously so they are sure to come out identical. The lower yards can be built in four steps described below.

#### Step 1-

The center of the lower yards is "octagon-shaped". The eight-sided section of the yard usually covered about one quarter of its length. While shaping your spar, try to avoid tapering this center section. You will place batten strips around the yard to achieve this eight-sided geometry. Not being tapered, it will make it much easier to prepare and assemble the batten strips around this section of the yard. This section of the yard can be tapered after the battens are added. NOTE: Drill a hole into both ends of the yard before you start to taper them. The outer stuns'l boom irons will be inserted into these holes later. It will be easier to drill them now since there is less of a chance that the wood will split. Taper the yards arms to match the plans.

For the octagon-shaped section of the yard, select some wood strips that are no thicker than 1/32" for the battens. To help find the correct width for these strips you will need to measure the circumference of the center of the yard. Then divide that by eight. Wrapping a strip of paper around the center of the yard is an easy way to find its circumference and then divide up the resulting space.

When cutting your wood strips to the width needed, make them slightly wider. Not by much. Since you are covering a rounded surface, the outside edges of each strip need to be beveled so you get a tight fit around the yard (Hence the need to make them slightly wider). The ends of these battens can also be rounded off as shown in the photo provided to create some extra detail. Once glued around the center of the yard, any small gaps can be filled with wood filler and sanded.

Two cleats called "sling cleats" are positioned in the center of the yard. These kept all of the rigging gear contained to the center of the yard. Additionally, two "yard arm" cleats were positioned at the end of each yard arm as shown on the plans. These cleats should be created thin and slender. Use a strip of 1/32" x 1/32" wood for the yard arm cleats, while the sling cleats in the center of the yard should be made using 1/16" thick strips (sand them down closer to 3/64" thick). Working with such small finicky pieces can get frustrating. Simply cut the yard arm cleats to length and glue them on as is. Then shape them after they are on the yards. Both cleats will then be in close proximity to one another which aids in producing a similar shape for both of them.

The course and topsail yards for the Syren carried stuns'ls. Four stuns'l boom irons were fitted to the yards for their use. There was a pair of inner and outer boom irons. The inner boom iron was positioned about 1/3 the distance from the end of the yard arm. This boom iron was a simple fitting with one iron band around the yard. This band had a second one attached to it with a short rod connecting them. The stuns'l boom was slid through this iron ring



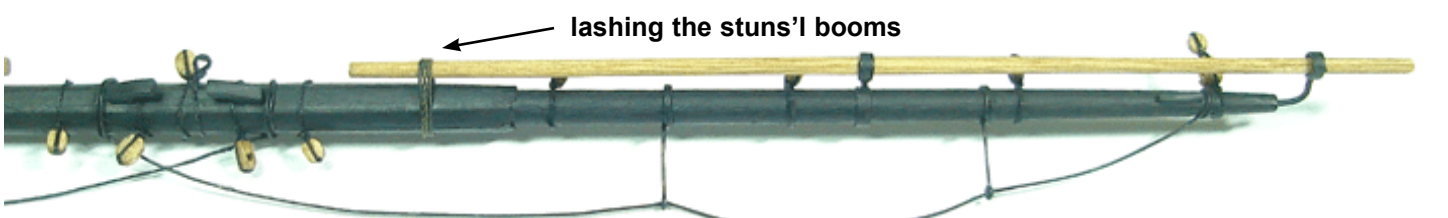
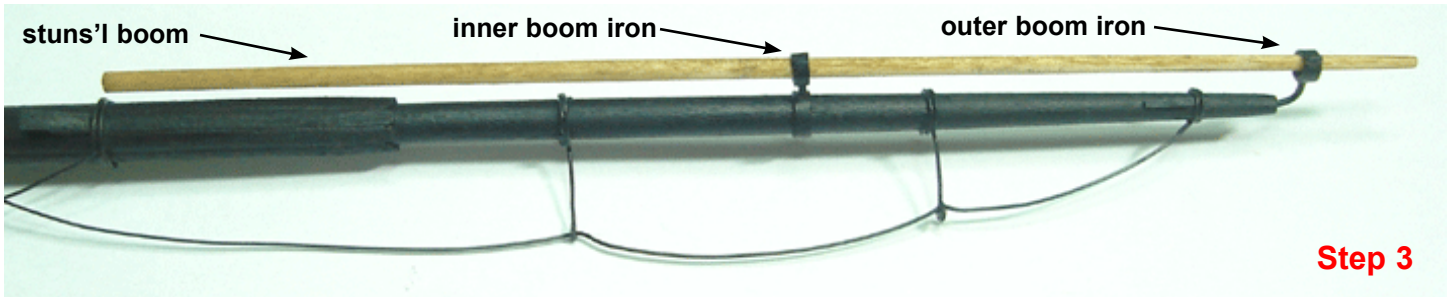
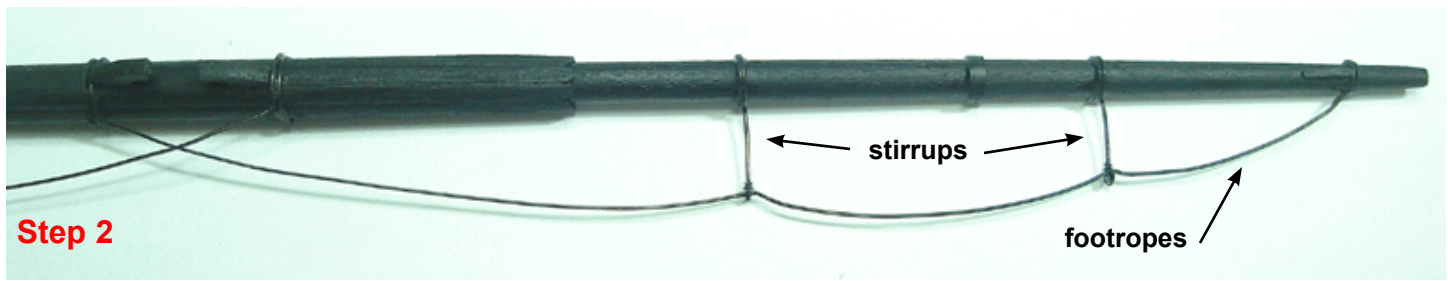
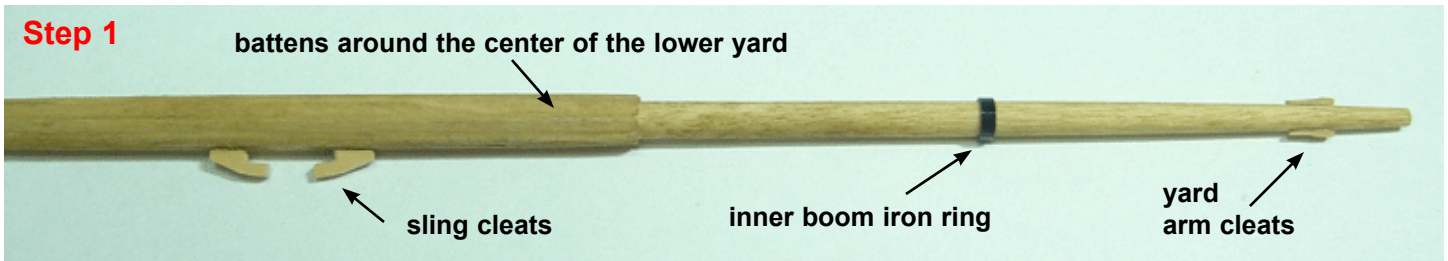

Some of the blocks and rigging have been added to the lower yard. Step 4

which was made slightly larger for this purpose. In some cases the ring was hinged so it could be opened but we are getting ahead of ourselves. At this point in the yard construction you need to only locate where the inner boom iron would be positioned. Using some black automotive pinstripe tape or black paper strips, wrap a 1/16" wide (or less) strip around the yard to simulate this iron band. If you have decided to paint your yards black, this would be the time to do it. If not, then some preparation for the outer boom irons can be completed next.

The outer boom irons consisted of an iron ring to support the boom also. A metal rod was also attached to it. This time however, it is bent to form a goose neck. The end of the goose neck had iron jaws which were slid onto the yard arm. The jaws were usually let into the yard arm and bolted on. The outside surface of the jaws was more-or-less flush with the surface of the yard arm. Two iron bands were sometimes wrapped around the jaws and yard arm to help strengthen the whole assembly.

To simulate the jaws simply paint them onto the ends of the yard arms. Since they were let into the yard arm this

makes perfect sense and it is a much simpler solution than creating an actual set of metal jaws. No soldering or complicated metal work is needed. Once finished, you could even add the "optional" pinstripe tape around the jaws to simulate the iron bands that sometimes secured them. These bands should not be as wide as the ones used to simulate the inner boom iron. Make them no wider than 1/32". This feature was not added to the prototype but you can add as much detail as you want depending on your level of experience. This also adds some additional detail to the yards which will show to good effect if you decide not to paint your yards black.

**Step 2 -** Foot ropes were hung from the yards so the sailors could have a place to stand while working the sails. They were hung from lengths of rope wrapped three times around the yard arm called "stirrups". The stirrups had an eye or thimble worked into the lower end and the footropes would be strung through them. As many as four stirrups were used on the yards of larger ships but as few as one or two for smaller yards or vessels. The stirrups and footropes for our model could be made from .018 black rigging line. You will have to adjust them after they are rigged. Various



stiffening agents can be used to process the line so it will lay with a natural swag. Some of the kinks and twists can be worked out of the line ahead of time of course. The rigging line is not heavy enough for gravity to allow them lay naturally.

But as an alternative, 28 gauge black wire can also be substituted. It can be used solely for the stirrups or for footropes as well. This was the method used on the model prototype. If bent around the yard and treated as if it were rigging line, the results just might surprise you. An eye is formed on the end of the wire with some needle nose pliers. This is sufficient for simulating the eye and thimble on the end of the stirrup. But to push the realism a bit further you could use some sewing thread to create a "cosmetic" seizing above the eye. It serves no purpose but to cosmetically enhance the idea that the stirrup is actually made from rigging line. Once again, the choice is yours depending on which method you feel most comfortable using.

Create four stirrups on each yard as shown on the plans and in the photos provided. You could hang them from the bottom/center of the yard after wrapping them three times around the yard. This can help conceal the fact that they are made from wire, although, in actual practice they would have hung off the back side of the yard. You can use either approach.

The footropes (28 gauge wire) are run through the eyes of the stirrups and wrapped twice around the yard on both ends. You can see in the photo provided where each end of the footrope is located. Use a needle nose pliers to create a slight bend in the footrope where it passes through the eye of each stirrup. Then create a natural looking swag between each segment of the footrope by shaping them with your fingers. The trick to using wire is NOT to make the stirrups and footropes hang too perfectly. You might

want to actually introduce some "imperfection" to how they hang. This will go a long way in helping push the illusion. Draping them with near perfect hanging swags is something that lends itself to closer inspection. Introducing an ever-so-slight bend now and again will do wonders for the overall affect.

### Step 3 —

With the footropes completed, focus your attention on the completion of the stuns'l boom irons. Several steps are described below for you that correspond to the photos also provided. Use a 1/8" brass tube to create the iron rings for the boon irons. This will allow the stuns'l boom to easily pass through them with room to spare. The iron rings will be slightly less than 1/16" wide when completed. To start the process use a simple razor saw available at most hobby shops. Use the saw to create a small cut in the tube. It's more like a "score" than a cut. This score does not have to go all of the way through the wall of the tube. The score is made 1/32" from the end of the tube. The purpose of this score is to provide a means to prevent the drill from slipping off the tube while drilling through it. See the pictures provided. The score is shown in step one.

For step two, drill the hole all the way through the wall of tube using the scored groove as a way to keep the drill from slipping. This score will be filled up with CA (super glue) afterwards so don't worry, it won't show up at all when the boom iron is finished. The hole must be the same size as 22 gauge wire. When done, cut the ring off of the tube so the boom iron is 1/16" wide with the hole in the center. You can sand down both edges to make the boom iron slightly less wide than 1/16". This also knocks down the burrs and roughness of the cut edges.

Step three - Bend a piece of 22 gauge wire to form the "goose neck" for the outside boom iron. The inside boom iron only requires a straight piece. Make them extra long so

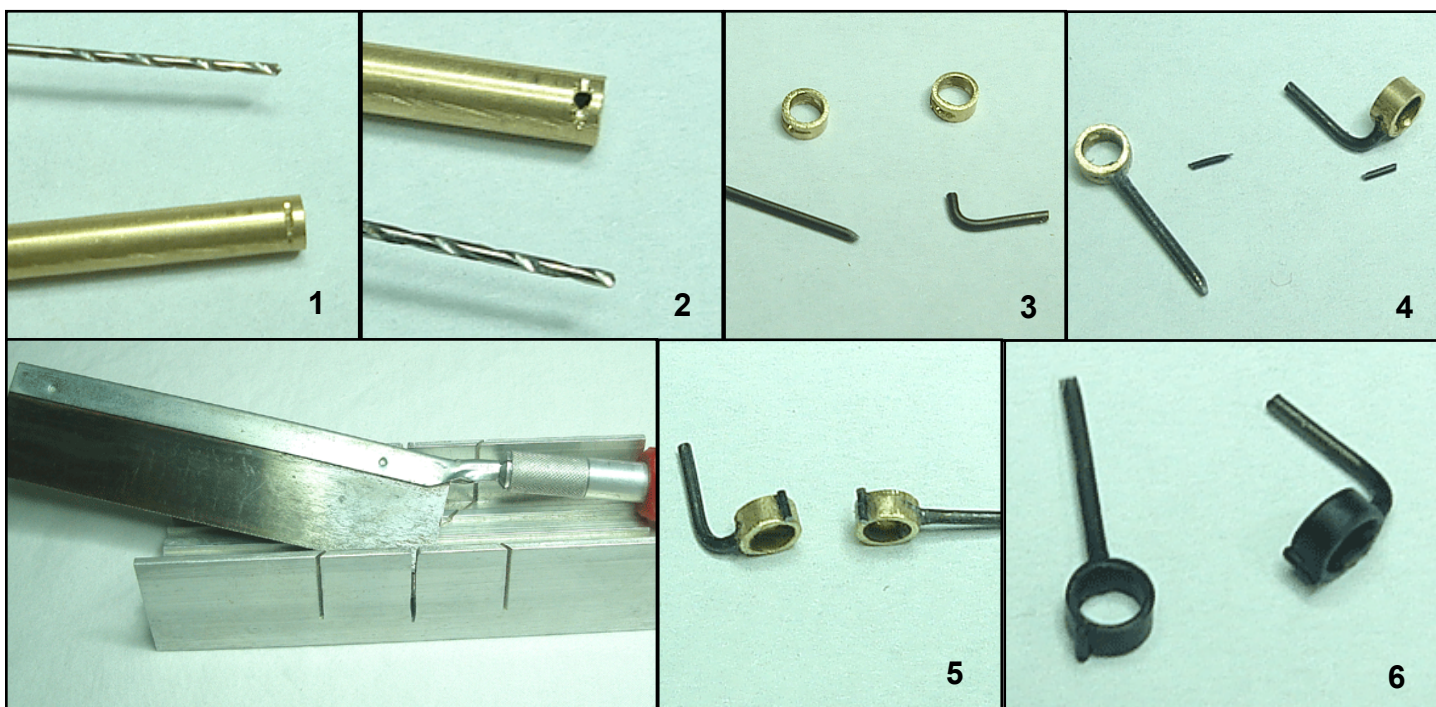



you will have a handle to hold while painting them later.

Step four - Glue the 22 gauge pieces of wire into position. Push them into the holes so the wire protrudes slightly into the tube. Once the glue dries, file the protrusion down flush with the inside wall of the tube. It will be quite sturdy. Remember that the stuns'l booms will be under no tension what so ever. There is really no need to solder these pieces together. The glue will provide more than sufficient strength here. Cut tiny pieces of 28 black gauge wire in preparation for the next step.

Step five — Glue the tiny lengths of 28 gauge wire to the rings. They will simulate the hinges that are often seen on some boom irons from this time period. You could add more detail if you wish. But this is usually sufficient and produces a nice clean simplified boom iron. File or sand the ends of the wire flush with the width of the tube.

Step six — To complete the boom irons paint them black. See the photos provided.

The boom irons can now be added to the yard assembly. They would have been set to a 45 degree angle above the yard on the fore side. Slide the end of the goose neck for the outer boom iron into the hole you drilled on the end of the yard. Establish the correct angle as noted. The inner boom iron is simply inserted into a hole drilled through the iron band you made on the yard arm earlier. If you used paper or pinstripe tape to simulate the iron band, then you should start the hole with the point of a sharp awl first. This will prevent the tape from twisting around the drill bit as you make the hole. That would ruin the finish and shape of your iron band. Cut the stem for the inner boom iron to length and insert it into the hole. Touch up any areas that need some attention with black paint and the process is completed. Avoid positioning the rings of the boom irons too far away from the yard arm. They should be placed no further than 3/32" or closer.

The stuns'l booms are made from a 3/64" diameter dowel. The outer ends are tapered. The inboard ends are not. In fact, you could sand the inboard end to an octagon shape. This was sometimes done with the stuns'l booms and it adds a nice touch to an otherwise plain stick. Slide them through the boom irons and add a drop of glue to prevent them from shifting out of position.

*This completes the construction of the yard.*

#### Step 4 —

At this point you can rig all of the various blocks and rigging to the yard using the plans as a guide. If you have decided to show buntlines and leech lines these blocks should be rigged towards the top-front of the yard as this rigging hung down the front side of the sail. The clew lines are rigged on the back side of the sail therefore these blocks should be rigged under the yard and positioned towards the aft side.

The lower yard around the turn of the 19th century had the topsail sheet block and lift block stropped together. These two blocks were rigged to the end of the yard arm against the cleats you shaped earlier. You can examine them on the plans. The block for the topsail sheet gives you the opportunity to improve the look of your model further. You could use a 1/8" single block for this "as is". But if you examine the drawing closely you will see that the topsail sheet block has a distinct shape. There is a small lip on the inboard side of the block. Showing this detail would be easy to achieve. Just start with a slightly larger block and shape it to match the plans.

Take the larger block and cut the lip into the inboard side of it with a sharp blade. Then round off all of the edges. You can see a topsail sheet block in the photo provided.

Lash the stuns'l booms to the yards using some .012 black rigging line as shown.

The centers of the lower yards have a simulated thimble lashed around it for the slings. This will be lashed to the thimble you created on the end of the sling with a lanyard. Use .018 blk rigging line to create this "stiffened/simulated" thimble and rig it onto the yard as shown on the plans.

A simplified truss is also shown on the plans for the lower yards. It would be a good idea to rig one side of the truss onto the center of the yard ahead of time. Use a generous length of .018 black rigging line for the truss. Let the loose end hang free for now.

The yard brace pendants can also be added at this time in preparation for final rigging. You should add as much rigging to the yards as you feel comfortable doing at this time. Examine the plans and choose the rigging elements that would be easier for you to add before they are in position on the model.

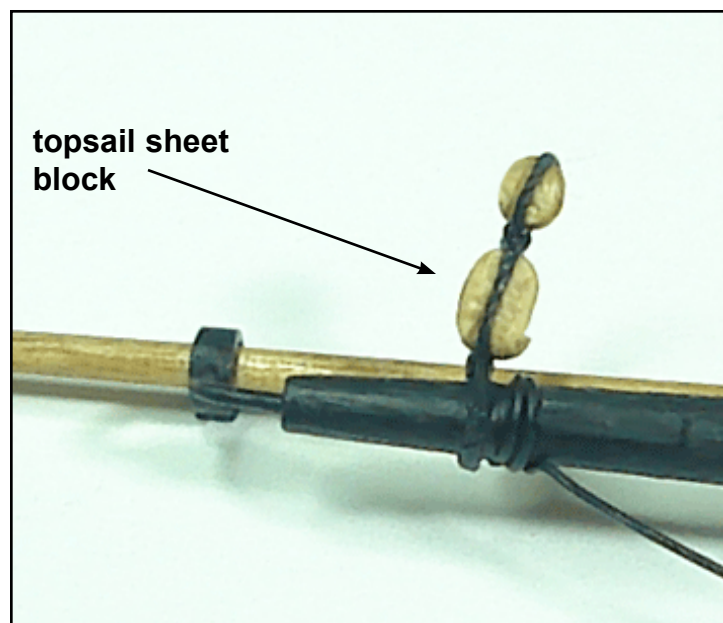



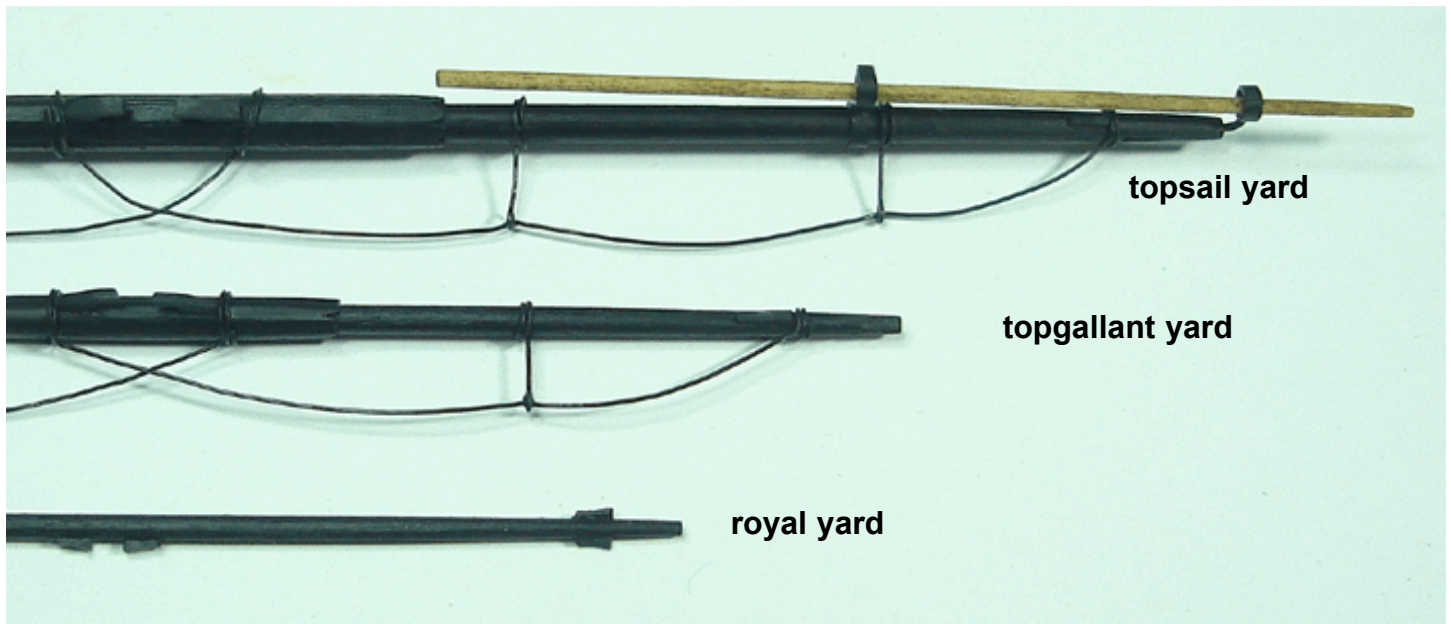

**topsail yard**

**topgallant yard**

**royal yard**

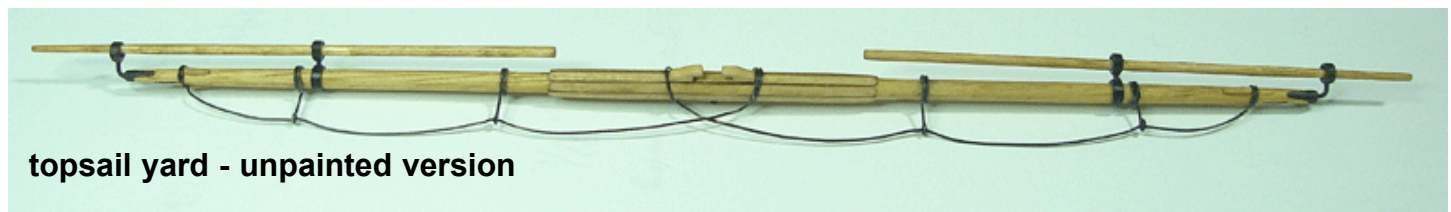

**topsail yard - unpainted version**



**topsail yard - unpainted version should you prefer this over the painted yards**

The lower yards can be pinned into position on the masts when they are completed. This will hold them in position and make it easier to complete the truss rigging and slings later. Pre-drill a hole into the center of the yard (aft side where it will rest on the mast). Insert a length of 22 gauge wire. Drill a corresponding hole into the lower masts (fore side) where the yards would be positioned. Glue the pinned yard into position on the mast.

**Topsail yards...**

The topsail yards are made similar to the lower yards. This time however, you will use a 1/8" diameter dowel to make them. There's no need to describe their construction in detail since the methods are so similar. Just be very careful to examine the plans thoroughly. Measure all of the elements for the yard and note the simulated sheaves made through the ends of the yards arms. A 1/8" diameter brass tube is used to create the boom irons for the topsail yard also. The number of blocks and their positions are also noted on the plans. Rather than a simplified truss, the topsail yards were secured to the mast with a parrel. The parrel consisted of small wooden ribs with round trucks between them. These are supplied with the kit and an illustration is provided on the plans to assist you with them. Pin the topsail yards to the masts as well just before you begin to rig them on the model.

**Topgallant yards...**

These are constructed using a 1/8" diameter dowel like the topsail yards. There were no boom irons for the topgallant yards. A simple truss is used to secure them to the mast. Since the topgallant mast is so thin, do not attempt to pin these yards into position before rigging them. You don't



want to risk breaking your mast in two after you spent so much time and effort rigging the model up to this point. Drilling a hole through the topgallant mast to except the pinned yard would make it very fragile. It might not hold up to the tension created by the yard braces and other rigging.

### **Royal yards...**

The royal yards are made using a 3/32" diameter dowel. The center of these yards is not octagon shaped. No battens will be required. Simply add and shape the cleats as shown on the plans. You should not pin these yards to the masts for the same reasons stated earlier.

### **Inboard rigging for the lower course sheets, tacks and braces...**

If you recall, there are several sheaves that were simulated through the hull. They are for the braces, tacks and sheets of the lower course yards. Examine the plans and you will see these lines as they work their way through the hull inboard where they are belayed to cleats along the bulwarks. It may be difficult to insert a line through the hull while rigging them. The bulwarks are quite thick and in two layers. An easy way to accomplish this is to simulate the rigging as if it were one continuous length running through the bulwarks. You will be rigging the outboard portions of the sheets, braces and tacks much later. But this would be a good time to rig the inboard portions of these lines. Check the weights and details on the rigging plans before starting.

Take a small length of rigging line and push the end into the sheave holes from the inboard side of the bulwarks. You only need to push the line into each sheave a little bit and then secure it with some glue. When it is dry and secure, you can take the lines and belay them to the appropriate cleats along the bulwarks. This should be done for the main course braces (.012 tan), sheets and tacks as well as the fore course sheets (all .008 tan). See the photo below that shows the main braces and sheets rigged on the inboard side of the bulwarks at the stern. It may look a little odd until you finally rig the outboard portions of these lines. But you will appreciate how much easier it was to rig them now instead of waiting until the bulk of the rigging would get in the way and make it difficult.



*These two photos show the inboard portions of the main course sheets and braces (below) and the fore sheet (above). It is best if you add these soon before getting to much rigging done. It will be easier to complete them with less rigging to get in the way. Not shown is the main tack which is handled in the same way.*





## Lower Yard slings and Jeer ties

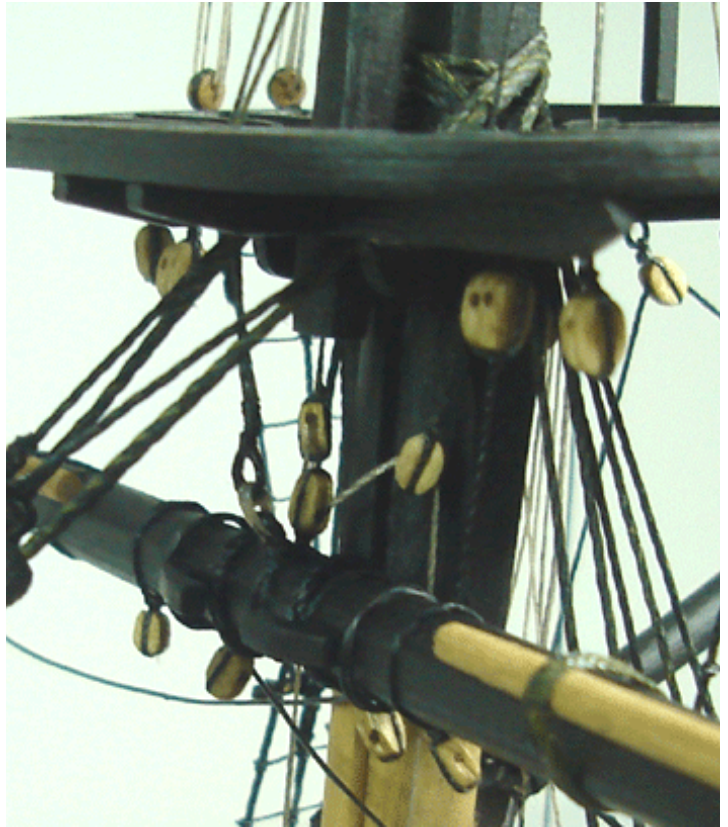
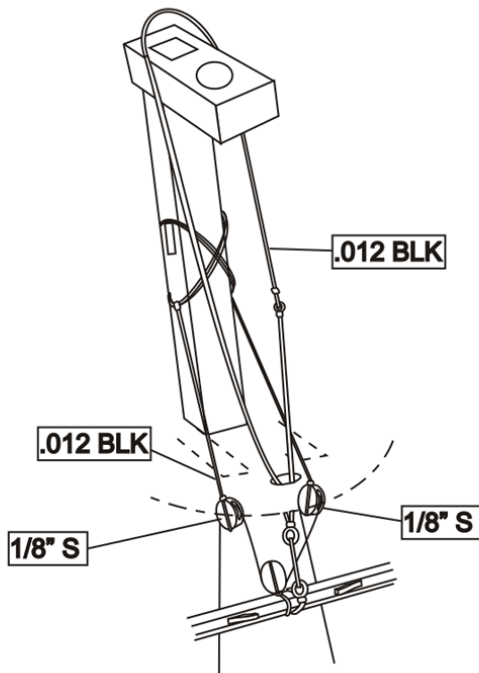

## Chapter Twenty Rigging the yards

Following the plans, add as many blocks and preliminary rigging as possible to the yards before attempting to rig them on the model. This includes the brace pendants, truss, ties and parrels, etc. Remember that the topsail, topgallant, and royal yards for the main mast will have their brace pendants rigged on the forward side of the yards. Examine the plans carefully. Once you have finished preparing the yards they can be rigged on your model. The rigging sequence for all of the yards has been detailed below in the order that was used to rig the prototype. Please note that these instructions are not intended to be a treatise on rigging a tall ship. There are many in-depth books that cover the rigging in detail for a ship during this time period. One such book, "The Masting and Rigging of English Ships of War, 1625-1860" by James Lees is one of the finest written and would be a reference you would return to over and over again.

### Main (lower) Course Yard Rigging...

**Truss** (.021 blk) — A simplified truss will be used on the lower yards. It holds the yard securely against the mast. Create a small eye on the end of the rigging line to start the truss by folding and doubling a length of rigging thread. Leave the doubled loose ends of the truss about 8 inches long. This will make it easier to complete the rigging after you pin the yard to the mast. Add the truss to one side of the yard (inside of the sling cleats). This is done by inserting the two loose ends into the eye and cinching it up tightly around the yard. Let the loose ends hang freely.

After pinning the yard on the mast, take the two loose ends of the truss around the mast and set it up on the other side

of the yard. You don't have to create an eye on this end of the truss. Just seize the truss closed after wrapping both ends around the yard. Add a drop of glue to prevent it from loosening.

**Lanyard for the sling** (.008 tan) — You should have already created a simulated thimble and lashed it to the center of the yard as mentioned in the previous chapter. Use some super glue to stiffen the eye as was described many times earlier in the project. Tie a length of .008 tan rigging line to this thimble on the yard. Use a simple overhand knot and apply a drop of glue to secure it. Run the lanyard between this thimble and the other simulated thimble you made on the end of the sling. The sling should be hanging below the front of the top (through the hole you created for it on the platform). Run it through both thimbles a few times and use some glue to secure the running end. Then snip off the excess line. See the detailed drawing provided on the plans.

**Jeer Ties** (.012 tan) — Examine that same drawing shown on the plans before setting up the jeer ties for the lower yards. One continuous length of line runs through the single block on the top/center of the yard. From here, the running ends on both sides of this block are taken through the "jeer blocks" under the top. These are the two single blocks you prepared earlier that are hanging through the lubber's hole from the masthead. Both loose ends are taken down to the base of the main mast and set up with a running tackle. You have created these running tackles before while rigging the backstays. Set up a working tackle after seizing a 1/8" single block to both ends of jeer



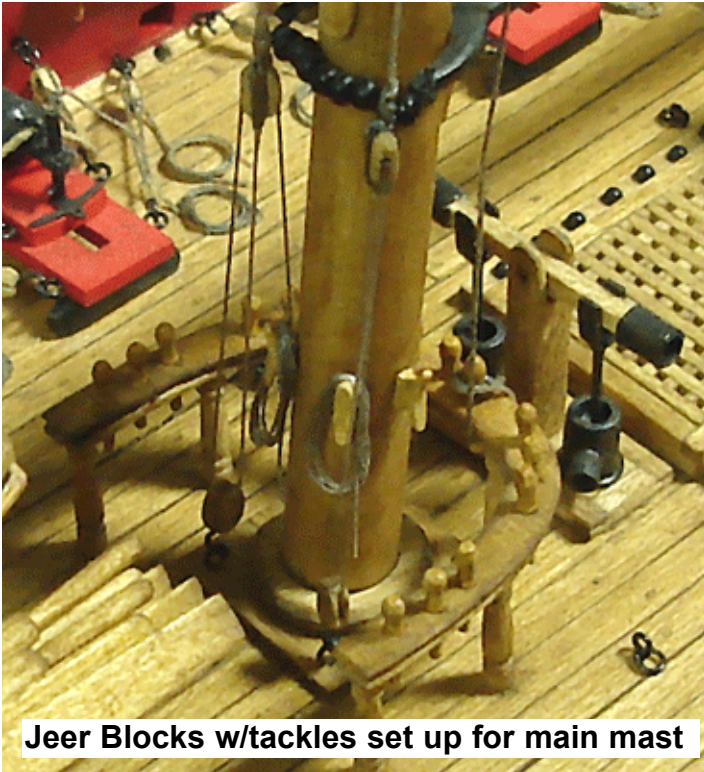

**Jeer Blocks w/tackles set up for main mast**

ties. A hooked single block will be used to complete each tackle. They should be secured to the eyebolts at the foot of the mast. The standing end of the halliard (.008 tan) for this tackle will originate from the upper block. Just seize the line around it and reeve the halliard through both blocks as shown on the plans. Tighten up the tackles after hooking them to the eyebolts on deck. Belay the running ends of these tackles to the mast cleats shown on the belaying plan and finish them off with rope coils.

**Lifts** (.012 tan) — Seize the standing end of the lifts behind the single blocks lashed to the lower mast cap. The standing ends are actually seized above the blocks on the lashing used to hang them from the cap. From here, run them through the lift blocks on the end of the yard arms. Then take the running end back up through the single blocks lashed to the cap.

The lifts are then taken down through the lubber's hole and set up with another running tackle. Use 1/8" single blocks for these running tackles. The tackles are hooked to an eyebolt on the channels much like the running backstays. Be careful to set up the lifts so the yard is not crooked and angled on the mast. It should be level and horizontal when viewing the model from the bow and stern. Belay the running ends to (4) and finish them off with a rope coil.

**Leech lines** (.008 tan) — Create a stopper knot on the end of some rigging line. Then run it through the outside single block on the yard arm. See the plans for details. From here, take the running end and reeve it through both single blocks hanging under the top. These are the outside pair of single blocks. Finally, take the leech lines down to the deck and belay them to (3) the pin rail along the bulwarks. Finish them off with a rope coil.

**Buntlines (.008 tan)** — First, create a block assembly using two 3/32" single blocks. Strop them together end-to-end. See the photo provided. You will need four of these block assemblies to rig the buntlines for both lower yards. Make sure you position the sheave holes for the block properly. The sheave holes should be on the inside of the assembly for both blocks.

Take a generous length of rigging line and create a stopper knot on one end. Run this line through the inner-most single block on the top of the yard. Take the line through the inner-most sheaves of both double blocks under the top. From here the running end should be reeved through one of the blocks on the block assembly you created. Then take the line back up through the remaining sheaves of the double blocks beneath the top. The running end of the line is brought back down to the yard arm and through the remaining single block (middle one) on the top of the yard arm. Pull the line to establish the correct height for the buntline block assemblies off of the deck. The double block assemblies should be positioned about 2 3/4" to 3" from the deck. Once you have established the correct position for the block assemblies, you can lock it in place by applying a drop of glue to that last single block on the yard arm. You can tie a stopper knot onto the line once the glue secures it in the sheave. Snip off the excess line.

**The falls for the buntlines** (.008 tan) are run through the bottom block of the block assembly hanging free at the moment. Take one end of the line and secure it to the fife rail adjacent to the belaying point (1). Just wrap the standing end once around the rail itself and apply a drop of glue to secure it. Then take the running end of the fall which runs through the buntline block and belay it to the pin on the rail (2). Finish it off with a rope coil.

**Braces, Clew lines, sheets and tacks** — These rigging lines for the main lower yard will not be completed at this time. If they were rigged now, they would certainly get in the way while trying to belay the other lines for the topsail, topgallant and royal yards. We will come back to these after the other yards have been successfully rigged in their entirety.

#### **Fore (lower) Course Yard...**

The rigging of the fore course yard is basically the same as described for the main course yard. There are only a few differences worth noting. Check the belaying plans for all of the correct belaying points. The leech lines will be taken through the outer-most sheaves of the double blocks hanging beneath the top. If you recall, the leech lines for main course yard were taken through a single block. But this time, a double block is needed because the additional sheave will be used for the spritsail yard braces.

The lifts will be set up with tackles that are hooked along the fore channels. This time however, you will belay the running ends of those tackles to the timber heads along the cap rail.





**Main Buntline falls with block assembly**

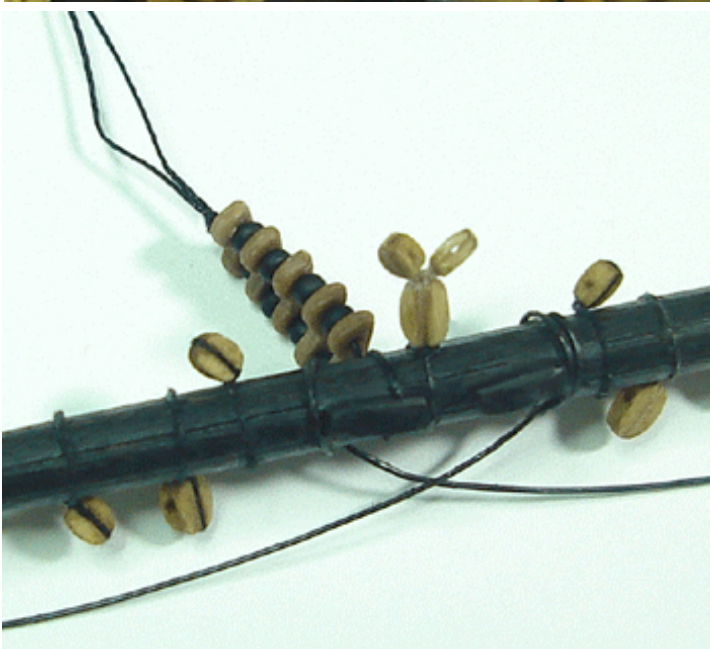

**Topsail yard parrels**

### **Main Topsail Yard Rigging...**

**Parrel** — Before you pin the Topsail yard to the mast, the parrel should be added as shown on the plans and the photo provided. Use some .018 black rigging line to string the parrel with the ribs and little beads supplied with the kit. The line is first seized around the yard inside the sling cleats. Keep the line doubled after you seize it with two long lengths so you can string your ribs and beads onto them. You will use five ribs separated by the beads on each topsail yard. Then seize the opposite ends together. Once the yard is pinned into position, you can bring the loose ends around the mast and secure it to the other side of the topsail yard.

**Topsail yard Jeers** (.012 Tan) — With the yard pinned to the mast and the parrel completed, the jeers can be rigged. Take a generous length of rigging line and run it through the 1/8" single block on the center of the yard. You will see a detailed illustration on the plans that show the jeers/tie for the topsail yards. Make sure you have two equal lengths of line to work with on both sides of the block. Each end should be run through their corresponding 3/32" single blocks hanging from the "center" cross trees. From here they run down the aft side of the mast through the lubber's hole of the main top. Then set up some running tackles aft of the mast for both falls. You have done this before and they are set up the same way as the falls for the lower yard jeers. They will both be hooked to the eye-bolts on deck. After belaying the loose ends of the tackles you can finish them off with a rope coil.

**Topsail Buntlines** (.008 Tan) — Make a stopper knot on the end of the rigging line. Run the line through the 3/32" single block on the top of the yard. Then take the running end through the smaller block that is stropped to the top of the jeer block on the center of the yard. From here, run the loose end through the 3/32" single block hanging from the aft-most cross tree. The buntlines are finally taken through the lubber's hole and belayed to (34). Finish it off with a rope coil.

**Topsail lifts** (.012 Tan) — The standing ends of the lifts are seized around the center of the topmast cap. See the plans for details. From here, take it through the lift block on the end of the yard and reeve the running end through the sister block you secured within the shrouds (lower block). Take the lift line down through the lubber's hole and belay it to (26) along the bulwarks. You should rig the lifts on both sides of the yard before belaying them. Then work them both (by pulling on the running ends) in order to establish the correct orientation of the yard. When you are satisfied, you can lock the yard in position by applying a drop of glue to the lift blocks.

**Topsail sheets** (.008 Tan) — Seize a 3/32" single block onto the end of a generous length of rigging line. Run the line through the topsail sheet block on the end of the lower yard. From here, the loose end is reeved through the 1/8" single block hanging below the lower yard as shown on the rigging plan. It is belayed to (5) but do not secure it to the



Details of some of the Main lower and topsail yard rigging completed...compare with the rigging plan

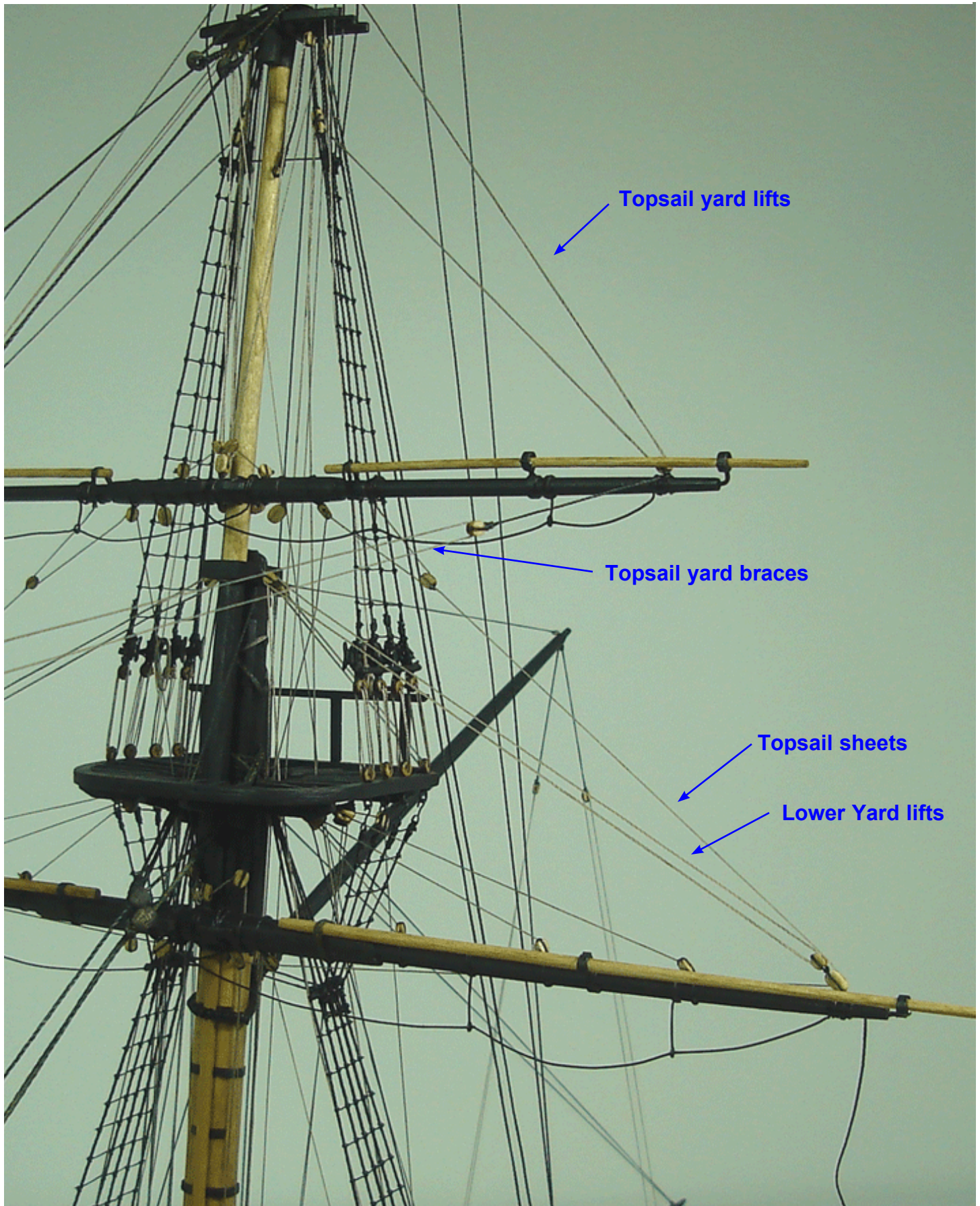

Can you find the buntlines and leech lines for the lower yard?? Topsail Clewlines??



belaying pin yet. Leave the topsail sheets loose for the moment while you rig the topsail clew lines. The clew lines will run through the single block you just seized on the end of the sheets. For this reason, adjustments will inevitably need to be made before you can permanently belay them.

**Topsail clew lines** (.008 Tan) — Secure the standing end of the clew line to the topsail yard as shown on the plans. Then run the loose end through the single block you seized on the end of the topsail sheet. Take the running end back up through the single block hanging from the topsail yard. From here the clew line is taken through the lubber's hole and belayed to (32). Before doing so, apply some tension to the topsail sheet and the clew line. Adjust both lines to establish the correct position for the block seized onto the end of the topsail sheet. Once you are satisfied, you can lock it into position by applying a drop of glue to the single block hanging from the topsail yard. This will help create the appropriate tension on both lines when you belay them on deck. Finish off both lines with a rope coil when you are finished.

**Topsail braces** (.008 Tan) — Seize two 3/32" single blocks to the main topmast preventer stay. Check the plans for their location. Then take a generous length of .008 tan rigging line and seize it to the stay just aft of the location of those blocks. The braces are run through the pendant blocks on the yard arms and then reeved through the single blocks on the stay. From here they are belayed to (28). Once again it is recommended that you rig the braces on both sides of the yard. Then work them both to establish the correct orientation of the topsail yard. Once satisfied, you can lock them into position by applying some glue to the blocks seized to the stay. Don't apply too much tension on the braces so that the stay is pulled awkwardly downward. Only apply enough tension so the braces don't appear slack.

### Fore Topsail Yard Rigging...

The rigging on the fore topsail yard is virtually identical to the main topsail yard. This is true except for the belaying points of course. The one notable difference would be the braces. Two pairs of double blocks are seized to the main stay instead of single blocks. Use the inside sheaves for the topsail braces. The outside sheaves will eventually be used for the Fore course yard braces. Examine the rigging plans carefully for the placement of both pairs of double blocks.

### Main Topgallant Yard Rigging...

As mentioned earlier, don't pin the topgallant or royal yards to the masts. This might weaken the masts too much and cause them to break under the pressure applied by the rigging. You can use a simplified truss to secure the topgallant yards to the mast. Use the same truss that you utilized for the lower yards, only this time you should use a lighter (.012 Black) rigging line. Secure one end of

the truss to the yard first (inside of the sling cleats). Then bring the loose end around the mast to secure the yard appropriately. Before doing so, the topgallant "tie" should be made fast to the center of the yard before it is installed.

**Topgallant Ties** (.012 Tan) — The tie for the topgallant yards is made by seizing an eye on the end of a generous length of rigging line. Then cinch up the tie around the center of the yard letting it hang freely. You may apply a drop of glue to the eye to keep the tie from loosening up. After you secure the yard to the mast, run the tie through the sheave you made on the mast. Examine the plans for details. There is a note on the plans which explain how the topgallant and royal ties should be set up on the channels. In this case, the tie will be set up on the starboard main channel. Create a running tackle on the end of the tie using 3/32" single blocks. The lower block of the tackle has a hook glued into it. The hook is made like all of the others you have made for the model (using 28 gauge blk wire). Hook the tackle to the eyebolt on the channel and then tighten it up to achieve the proper tension. Belay the running end of the tackle to (37) the cleat on the bulwarks noted on the belaying plan.

**Topgallant buntline** (.008 tan or sewing thread) — Make a stopper knot on the end of a generous length of rigging line. Run it through the single block on the center of the yard. Bring the loose end up through the single block hanging from the topgallant mast. Bring it down to be belayed to (54) on deck. Be sure to run it through the lubber's hole of the main top first before you belay it to the rail.

**Topgallant lifts** (.008 Tan) — Seize the standing end of the lifts around the topgallant pole as shown on the rigging plan. Run the loose end through the lift block on the yard arm and then back up through the blocks on the mast. From here bring the lift line down through the lubber's hole and belay them on deck. Rig them both (port and starboard) so you can establish that the yard is level before you belay them (to the rails along the bulwarks 41).

**Topgallant sheets and clew lines** (.008 tan) — These two lines are rigged similar to the topsail sheets and clew lines. This time however, the sheet does not have a single block seized to its end. In this case the topgallant sheet simply has a stopper knot on its end. The clew has an eye on its end. Run the sheet through the eye of the clew line until the stopper knot is hung up against the eye. Then take the clew line through the single block hanging from the yard.

Run the sheet through the sheave hole you made on the end of the topsail yard. From here the sheet is reeved through the 1/8" single block hanging below the topsail yard. Work both ends until you establish a good location for the stopper knot and eye connecting both lines. Lock them into position with some glue when you are satisfied.

With the clew line and sheet secured, you can now bring both running ends down through the lubber's hole and



**Topsail, Topgallant and royal yards rigging completed**





belay them on deck (48) and (30). Finish them off with rope coils.

**Topgallant braces** (.008 tan) — There are no brace pendants for the topgallant and royal yards. Simply seize some rigging line to the end of the yards and run them forward through a 3/32" single block seized to the stay. You will have to seize two single blocks to the main topgallant stay as shown on the plans. The running ends of the braces are belayed to shroud cleats in the fore top. Don't apply too much tension on these braces because the main topgallant mast is very slender and easily pulled forward. This will cause your stays and topsail yard braces to go slack. Apply only enough tension to the braces to ensure that they aren't themselves slack before securing them in the fore top.

### Fore Topgallant Yard Rigging...

Except for the belaying locations, the rigging for the fore topgallant yard is identical to the main topgallant yard. The only thing worth noting is that the tie will be set up on the port side channel rather than on the starboard side. Examine the rigging and belaying plans carefully for all of the details. The braces will also run through single blocks that are seized to the main topmast preventer stay.

### Main Royal Yard Rigging...

Secure the yard to the mast with a simplified truss as you did for the topgallant yard. The truss for the royal yard is made using .008 tan rigging line. Before securing the yard to the mast, don't forget to add the royal tie (.008 tan) to the center of the yard first. This tie is also made the same way as the tie used for the topgallant yards. The tie is run through the sheave you made in the royal pole. Be very careful when setting up the tackle for the royal yards. The mast is very slender and will bend very easy under the tension of the rigging. The tie is set up with a running tackle like the topgallant yard. This time however, the tackle is set up on the port side to an eye bolt on the main channel.

**Royal lifts** (.008 tan) — The standing end of the lifts is seized around the end of the yard arm. From here it runs through the single block hanging from the mast. Bring it down to the deck and belay it to (42). But first, the lifts should also be taken through the lubber's hole of the main top. Finish them off with rope coils.

**Royal clew lines and sheets** (.008 tan) — These lines are rigged just like the topgallant clew lines and sheets. Take both running ends through the lubber's hole and belay them on deck (51) and (52).

**Royal Braces** (.008 tan) — Same as the topgallant braces except they will run through single blocks seized to the main royal stay. Belay the running ends to shroud cleats in the fore top.

### Fore Royal Yard Rigging...

This is the same as the main royal yard rigging except

for belaying locations. Check the plans for details. Brace blocks are seized to the main topgallant stay.

Now that most of the rigging is completed, the braces, sheets, tacks, and clew lines for the lower yards can now be addressed. They will no longer get in the way while belaying any of the remaining lines. But as you are probably now discovering, with each additional line you finish rigging, the next one becomes even more challenging to complete. A web of rigging has slowly developed and it becomes increasingly difficult to navigate through them. Belaying the running ends to the pin rails along the bulwarks gets more challenging with each completed line. A good set of rigging tools (long tweezers or wooden sticks with hooks and forks created in their ends) can assist you with reaching into this maze of rigging. See the illustration provided which shows some examples of these homemade tools.

**Main course (lower yard) braces** (.012 tan) — These lines will be originate from the hull sheaves at the stern. They are the ones that you made just above the quarter badges. Take a generous length of rigging line and seize it to the ring above the upper sheave. Then run the line through the brace pendant block for the main yard. From here it will be taken back to the upper sheave through the hull where you will insert the end of the line. Apply a drop of glue to the line and push it into the simulated sheave with the tip of an awl. This will complete the outboard portion of the brace rigging. You should have already completed the inboard portion.

Note: It may be helpful to rig the braces on both sides of the hull for this lower yard before you permanently glue the loose ends into the sheaves. This will give you the opportunity to work both lines to establish the proper orientation of the yard. Then you can lock the yard in position by applying a drop of glue to the brace pendant blocks sheaves. This will help you establish the appropriate tension on the braces as you push them into the hull sheaves.

**Fore Course Braces** (.012 tan) — These braces are seized to the Main stay where you originated the braces for the topsail yard. From here run the line through the pendant blocks on the fore yard. Then the line is taken through the open sheaves of the same double blocks that used for the topsail braces. Belay to (17) and finish off with a rope coil. Rig both sides before belaying them, just as you did for the main braces which help establish the correct position for the yard.

**Main course sheets, tacks and clew lines** (.008 tan) - These three lines will be rigged together. All three come together in a block assembly hanging from the yard. Examine the plans carefully for all three lines. Please note that the block assembly is shown hanging from the clew line on the plans. It is shown hanging very low. This would not be the case and it was only shown this way because there was room in that section of the plan sheet to do so. The block assembly should be pulled up closer to the yard as shown in the photos of the prototype provided.





The first thing you should do is create four block assemblies. You will need four to rig these lines on the main and fore yards. Each assembly made with two 3/32" single blocks and one 1/8" single block. The larger block is for the course sheets. Start the assembly by seizing a toggle onto the end of some .008 black rigging line. The toggle is just a small length of wood (very small) that can be made by shaping and sanding a toothpick. You can see the toggle in the photos provided. You can get a sense of its size by comparing it to the blocks also shown in those photos. The rigging line should be kept doubled after you seize the toggle to it. Then create another seizing about 1/8" away from the toggle. You can just tie a simple overhand knot and apply a little glue to secure it. You will be sliding two stropped blocks onto the assembly shortly as shown in that photo.



To create the stropped blocks, simply create a small eye on the end of some rigging line. Then secure a 3/32" block against the eye with a drop of glue. When it dries, bring the two loose ends of the strop around the block and tie an overhand knot on the other end of it. Secure that knot with a drop of super glue (CA) and snip off the excess line. Do the same using a 1/8" single block also. Then slip both onto the toggle as shown in the first photo.



To complete the block assembly, add the remaining 3/32" single block to it. Just secure that block with the two loose ends from the toggle the same way you did it for the other two blocks. Glue it against the seizing and bring the two





### Fore Course sheets, tacks and cluelines

loose ends around the block to be knotted off. Snip off the excess when you are done. Make four of these block assemblies.

**Cluew line for the main course** (.008 tan) - Seize the standing end of the line around the yard. You can find the location by examining the plans. Then reeve the loose end through the 3/32" single block of the assembly. Use the block that is attached to the toggle. From here, bring the loose end up and through the block hanging from the lower yard. Pull the loose end until you are satisfied the block assembly is positioned at the appropriate height below the yard. Then lock it in position by applying a drop of glue to that block hanging from the yard. Belay the loose end of the fall to (6) and finish it off with a rope coil. The block assembly should now be hanging free below the yard.

**Main course sheets** (.008 Tan) — Run a length of rigging line through the 1/8" single block on the block assembly. Make sure the rigging line is long enough that you can take both loose ends to the remaining hull sheave at the stern. Seize one loose end to the ring beneath that sheave. Then pull the other loose end and glue it into the false hull sheave. Don't pull it so tightly that you pull the entire block assembly towards the stern. You should in fact hold the block assembly directly under the yard while you push the loose end of the sheet into the sheave. Apply a little tension to the line while doing so. When you finally let go, the entire assembly will go slack, but this is OK. When you rig the Tack next, it will create the oppos-

ing tension needed. The inboard portion of the main course rigging should have been completed earlier.

**Main course Tacks** (.008 tan) — Seize one end of the line to the iron ring on the side of the hull. Examine the rigging plans for its location. Then take the line through the remaining single block of the block assembly. From here the line is glued into the false sheave through the ship's hull. This is the sheave located just aft of the fore channels. Apply enough tension on the line as needed so that none of the sheets, clew lines or tacks go slack. Just push the line into the sheave with the point of an awl after applying some glue. Keep pushing it into the sheave further until the appropriate tension is created on all of the lines.

**Fore Course Clew lines** (.008 tan) — Same as the main course clew lines. Belay to (16) and finish it up with a rope coil. Try and establish the same distance below the yard for the block assemblies with toggle.

**Fore course sheets (.008 tan)** — Examine the rigging plans. Same as the main course sheets.

**Fore course tacks** (.008 tan) — This is a little different than the tack for the main course yard. You must first seize a 3/32" single block to the end of the bumpkin. The bumpkins are the long spars resting on top of the head rails. Examine the rigging plans for details.

Seize the rigging line to the end of the bumpkin (just behind the single block you just seized to it). Then take the line up to the remaining block of the assembly hanging from the fore yard. From here it runs back through that single block on the bumpkin where the loose end is taken inboard and belayed. Belay to (18) and finish off with a rope coil.

### The Spritsail Yard Rigging...

The spritsail yard is made just like all of the others. Follow the plans to taper a 1/8" dowel. Add all of the sling and yard arm cleats. The spritsail yard will also need stirrups with footropes. In addition, there are four eye bolts (fairleads) positioned along the top of the yard. These will be used for the guy rigging. Add the brace pendants and lift blocks prior to rigging the yard on your model. You will use the same simple truss/sling to secure the spritsail yard under the bowsprit. The yard is positioned just below the sling saddle on the top of the bowsprit. After the yard is secured under the bowsprit with the sling/truss you can rig the short length of line that runs from the center of the yard to the eyebolt on the bottom of the bowsprit cap. This line can be seized around the center of the yard ahead of time so after the sling is completed you only need seize the other end of it to the eye bolt on the cap. Use .012 tan rigging line for these.

**Jib Guys** (.012 black) — The guys are seized around the tip of the jibboom and flying jibboom respectively. From here they are run through the eyebolts (fairleads) on the top of the spritsail yard. "Stiffened" eyes are made on the loose ends and they are lashed to the eyebolts on the fore side of





the cathead. They are essentially set up the same way as the martingale stays at the bow. See the photo provided and examine the rigging and belaying plans for details.

**Spritsail Lifts** (.008 tan) — The standing end of the lifts is either seized to the eyebolt on the bowsprit cap (just behind the single block reserved for it), or it can be stropped around the block itself. From there it is taken through the single

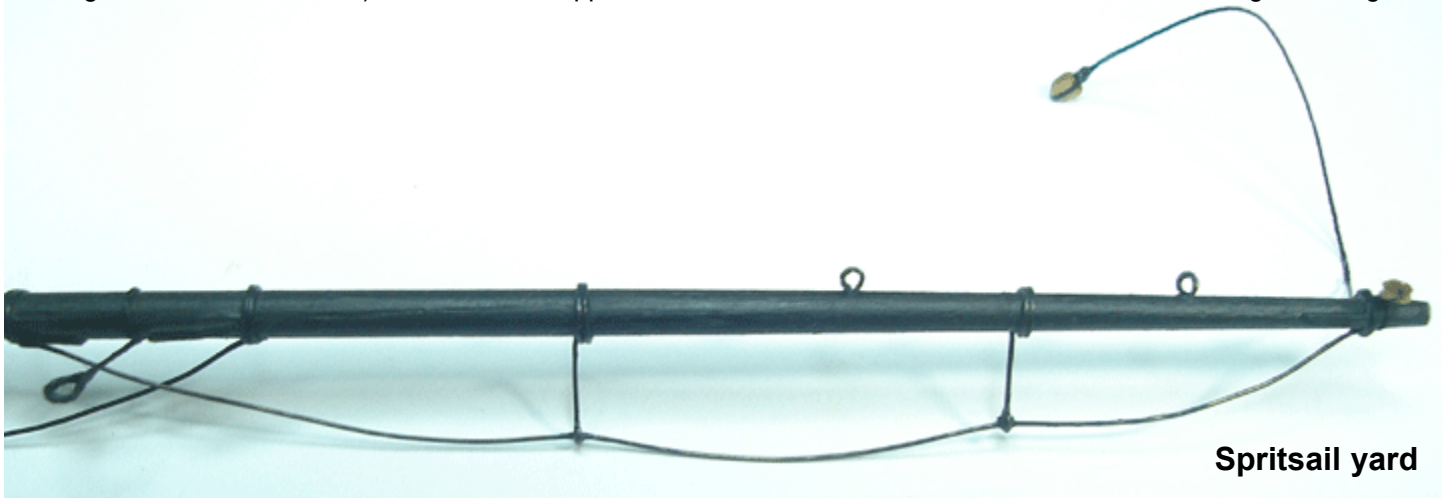

**Spritsail yard**



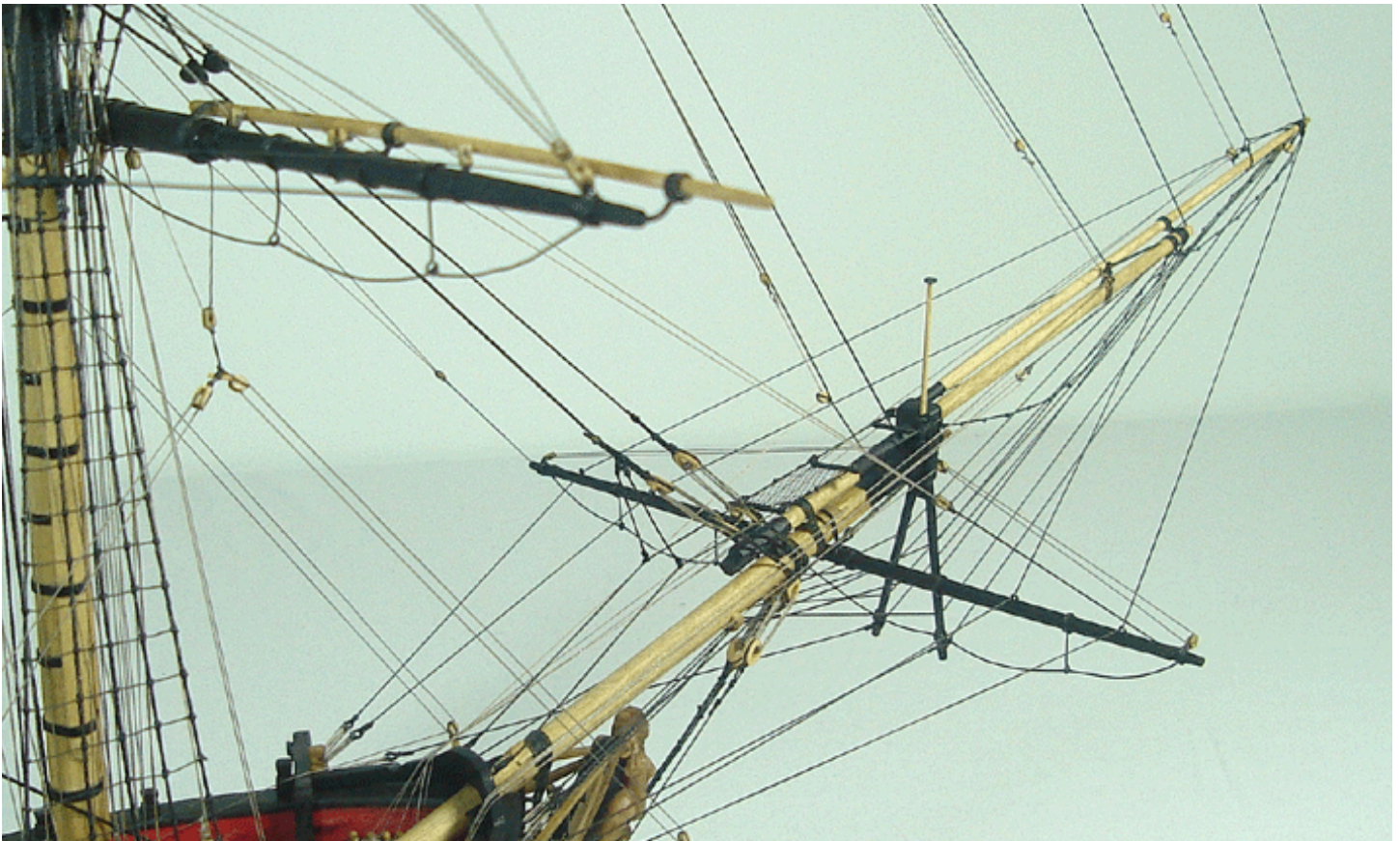

block of the yard arm and back through that block secured to the cap. The loose end is then taken inboard and belayed to (20). Finish them off with a rope coil.

**Spritsail Braces** (.008 tan) - The standing ends are seized to the fore stay (above the mouse). The loose end is run through the single blocks of the brace pendants. Then, they are brought up to the fore top where they are run through

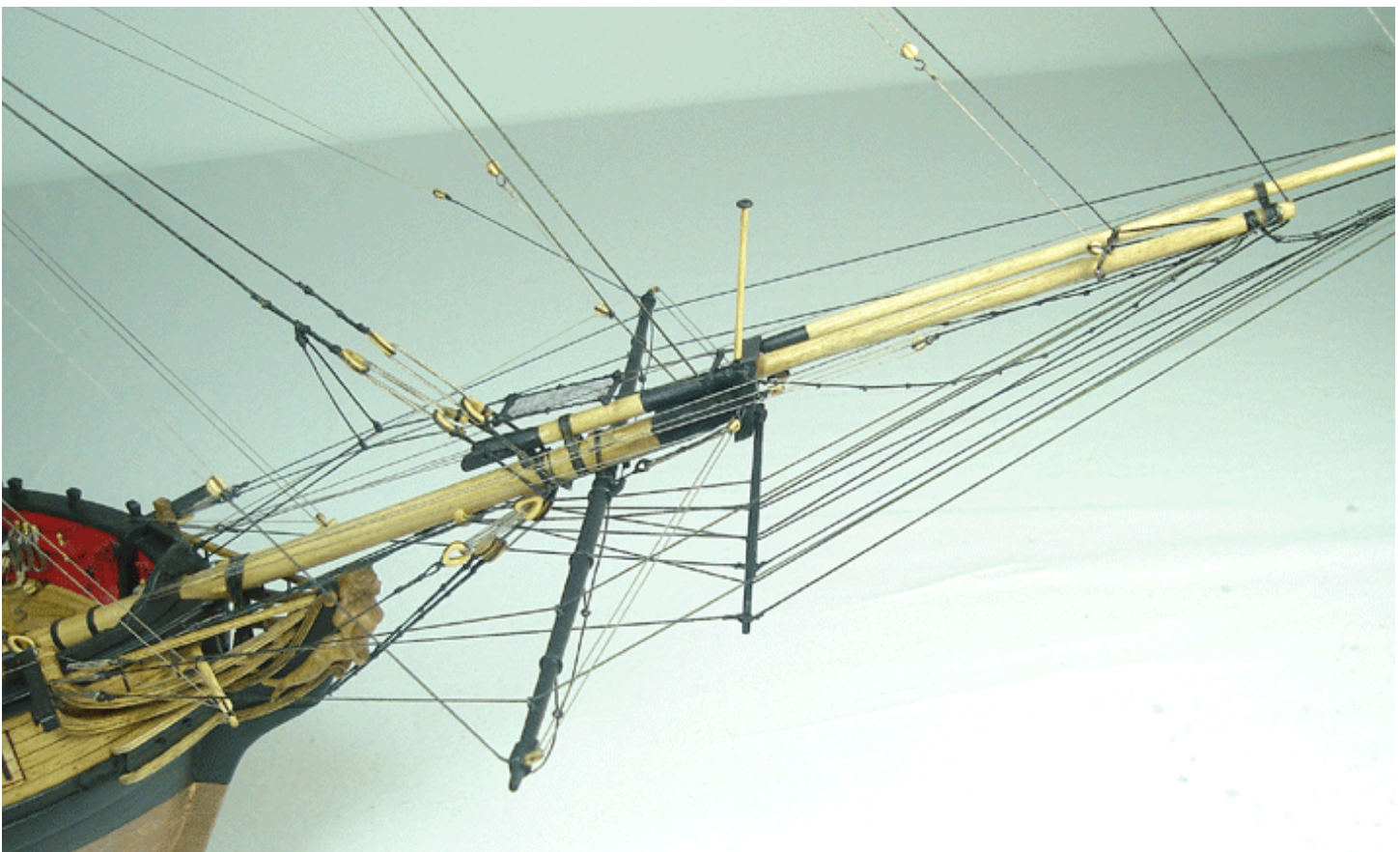





## Chapter Twenty One Anchors and Flags

Two cast Britannia metal anchors are supplied with kit. The anchor and anchor stocks are both cast and need to be glued together. Examine the plans for details. One alternative can easily improve the results. The Anchor stock is a simple element to make from scratch. Use the appropriate size wooden strips to create both halves of the anchor stock. Not how the stock tapers on three sides. The top of the anchor stock is not tapered. It is easier to complete the tapering of the anchor stock after the halves are glued together. Notch out the center of each half so when they are joined the anchor can be slid through the stock. See the photo provided. Wrap some 1/16" wide black pinstripe tape around the stock to simulate the iron bands. Several treenails can also be simulated on both sides of the stock between each iron band. The look of a wooden stock will improve the overall look of your model. Paint the anchor black.

Then create the iron ring using 22 gauge black wire. Place the ring through the hole on the end of the anchor. Depending on your level of experience, the ring could be wrapped (served) with sewing thread to add another optional detail. This is shown on the plans.

While examining the plans you will also notice the anchor buoy. These were used to mark the location of the anchor and anchor cable so ships could navigate safely around them. You will need to make two. They can be shaped from wood or you could use polymer clay to sculpt them. Clay was used to make the two buoys on the prototype. They should be painted a muddy brown color afterwards. The buoys would have been tarred to preserve them. See the step-by-step photos provided. Note in the first photo that two eyebolts were inserted on each end of the buoy. Don't insert them all of the way. Leave about 3/64" between the eye and the buoy. You will be seizing the rigging harnesses around the base of each eye bolt and you

need to leave a bit of the stem of the eyebolt exposed. Each buoy is about a 1/2" long (not including the eyebolts).

While you wait for the paint to dry on each buoy, you can start creating the two rigging harnesses needed for each of them. Four in total will be needed. The second picture shows three knotted lines on another length of rigging. The line used was tan .018 line that was also muddied up to look weathered. Don't apply too much glue to each knot. You will need to slide these three lines to adjust their locations on the buoy. If you add some glue, immediately slide the knot back and forth to insure they remain moveable.

The harness is wrapped around the buoy and secured with an overhand knot. (Third photo) Apply some super glue (CA) to secure that overhand knot. Then slide the three





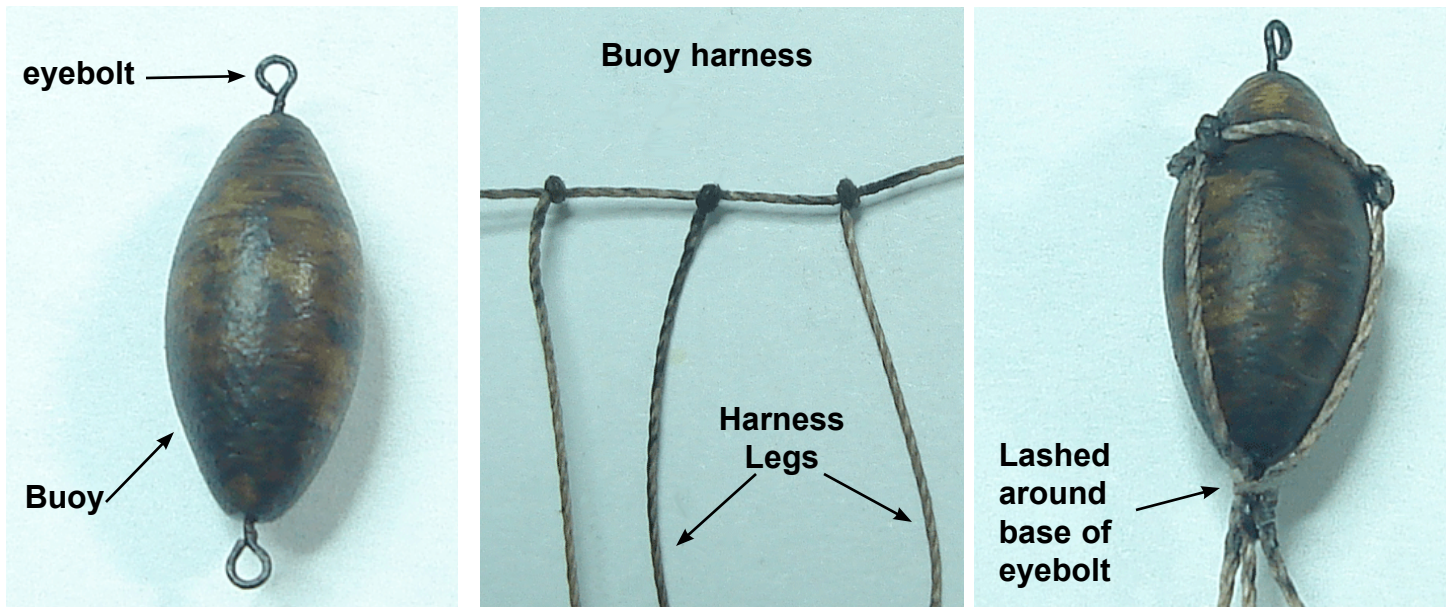

knotted lines into position around the buoy. Space them evenly around the buoy. Then take the three legs of the harness to the eyebolt on the opposite side. Seize them around the base of the eyebolt with some rigging line. Cut off the excess of the three harness leg strands after applying some glue to the knot to secure them.

Then repeat the process for the other side of the buoy (fourth photo). Note that the three legs of the second harness should be led under the first harness before you secure them around the base of the eyebolt. This detail is shown clearly on the plans. With the anchors and buoys completed you can prepare them for rigging on the model.

To prepare the buoy, seize two lengths of .018 rigging line to each end of the buoy. Both lengths will be seized to the shrouds later. For the anchor, rig another length of .018 tan rigging line to it as shown on the plans. The rigging is glued to the shaft of the anchor and the loose end is clove hitched around its base. Examine the drawing on the plans carefully. It would be better to clove hitch the line around the bottom of the anchor first and then glue the end to the anchor shaft afterwards. Wrap two lashings around the line and shaft to complete it. Finally, add the anchor cable (.083 tan) to the anchor. Use a generous length of line because it needs to hang gracefully at the bow after you run it through the hawse holes. Then it will be wrapped around the riding bits before it works its way down the holes in the hatch grating mid ship. A simple, loose overhand knot can be used to rig the cable to the anchor ring.

Glue the anchor in position to secure it on the cap rail. This will make it easier to create the lashing around the anchor and timberhead. See the photo provided. Once the anchor is held firmly in position, seize the loose end of the buoy line to the forward-most shroud. Seize it just above the second row of ratlines. Add a drop of glue to the seizing and cut off the excess line. Then take the buoy and secure it to the shrouds. Seize

the upper buoy line first. Place it high enough on the shrouds that the lower buoy line can be seized to the exact spot where the line from the anchor was seized. See the photo provided. Create rope coil and lash it to the spot where these two lines are secured to the shroud. This will hide the fact that these two lines are actually two separate pieces. The line from the anchor to the buoy was actually quite long. It had to be long enough to use in fairly deep waters. So don't be shy with that rope coil. It must be large and contain quite a few coils of rope. A smaller rope coil can be made and lashed to the upper buoy line to complete this step. This coil is smaller and was only used to secure the buoy to the shrouds and fish the buoy out of the water. An additional photo shows the model after the rope coils were added.



**Completed buoy. Note how the harness legs go under the other harness as the work their way down to be lashed to the base of the eyebolt.**





## The Flags...

This model of the Syren has two flags. Both are made of regular office-grade paper. You will notice that they are doubled with a mirror image. After cutting them out, fold them along the center line between the mirror images. Glue both halves together using a glue stick. While the glue dries, wrap the flag around different sized dowels to shape it as if it were blowing in the wind. The smaller one is simply lashed to the staff on the bowsprit cap. Drill two small holes on the inside corners of the flag. Use some sewing thread to lash the flag to the staff. Make any adjustments afterwards to make the flag look like it is hanging as naturally as possible. Should you need another set of flags...simply download the full color version of this chapter from our website [www.model-expo-online.com](http://www.model-expo-online.com) You may want to shape more than one flag so you can choose the one that looks best before you place them on the model.

Next, take the anchor cable through the hawse holes. Establish a nice graceful curve outboard and lock it into position by applying some glue to the line inside the hawse hole. The loose end of the cable inboard is wrapped around the riding bits as shown in the photos. Then push the end of the cable into the holes of the hatch gratings. You may need to apply a little glue to the bottom of the cable in order to get it to sit nicely on deck. Especially where it first touches the deck on either side of the riding bits. Note how the cable runs inside of the lashings for the long boat. It should run alongside the forward hatch.

To finish rigging the anchors, two more lines need to be completed. The first is the anchor stopper cable. This line (.018 tan rigging) will have a stopper knot made on one end. Run the line through the hole created on the top of the cathead. Run it through from top to bottom. The line is then taken through the anchor ring and then around the external sheave on the cathead. This is the sheave you made on the aft side of the cathead. You can add a drop of glue if needed to hold the line in that sheave. The loose end is finally belayed to the "taller" timberhead just alongside the cathead. Finish it off with a rope coil afterwards.

The final line is the tackle for the anchor. A hook will be added to a 5/32" double block. Normally this block would have an iron stop. But for our model that detail can be omitted. To create the tackle, seize a length of .018 tan rigging line to the unoccupied eyebolt on the forward side of the cathead. From here the line is taken through the sheaves of the double block and the cathead. Pull the tackle so the block is firmly hooked to the anchor ring. Then belay the line to the inboard cleat on the cathead. Finish it off with a rope coil.

The larger 15 star flag is flown from the gaff. Use some .008 tan rigging line to rig the flag halyard first. Belay one end of the line to the cleat in the inboard side of the stern transom. Then run the line through a 3/32" single block on the end of the gaff. Bring the halyard back down to another cleat on the transom. It really doesn't matter which one. Finish off both with rope coils. Prepare the larger flag the same way as the smaller one. Drill two small holes through the inside corners of the flag before trying to shape it with the dowels. When you are satisfied with the shape, lash the flag to one of the falls of the halyard. See the photos provided

## Congratulations!!!

### The model is now completed.





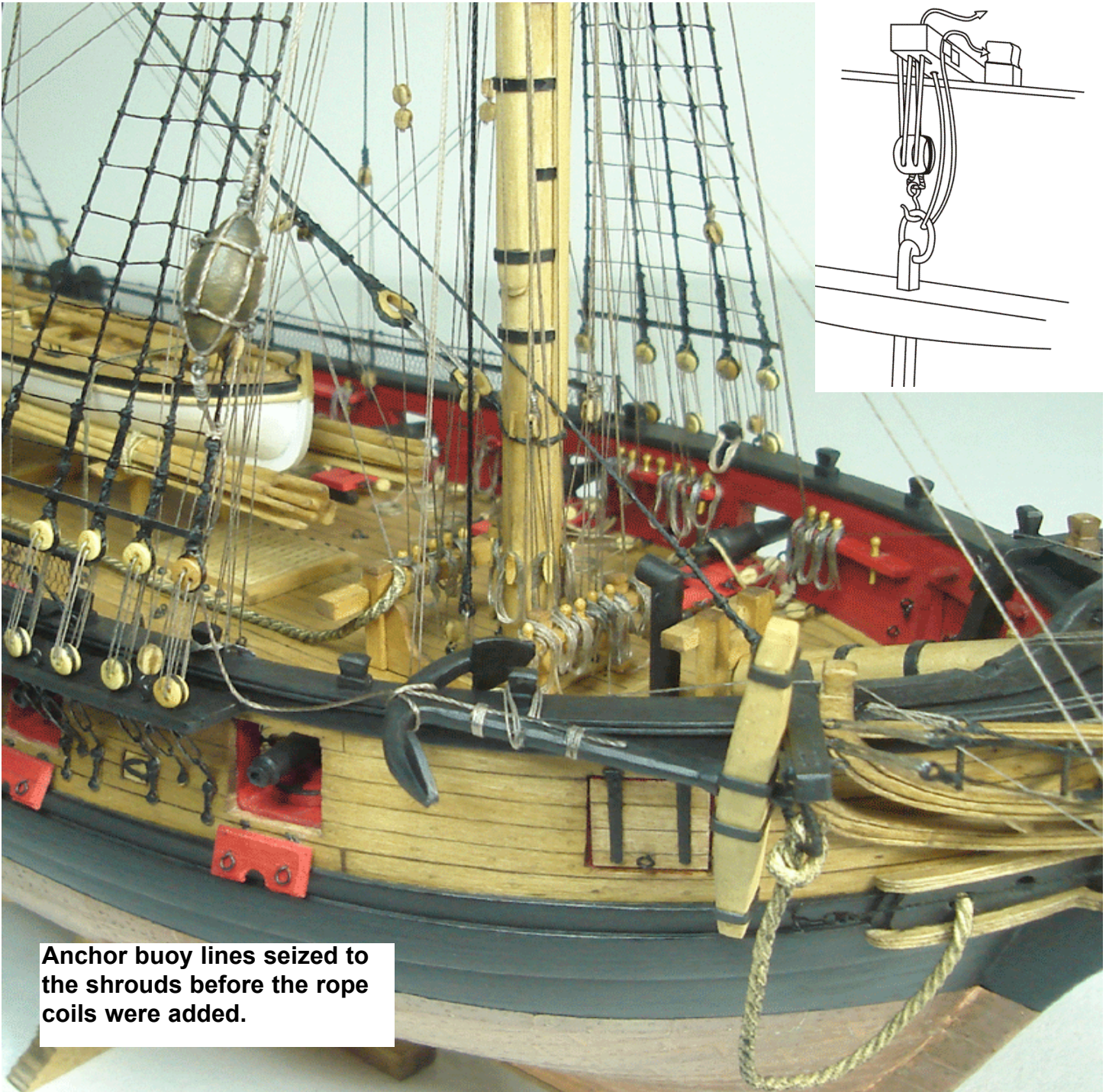

**Anchor cable taken around the riding bits and led into the holes in the hatch gratings.**





