

MST
MAX SPEED TECHNOLOGY

RMX 2.5 RTR

1/10 SCALE RC RWD HIGH PERFORMANCE DRIFT CAR

EXPLODED MANUAL

ON ROAD USE ONLY

SPECIFICATION: 1/10 Drift Car
WHEELBASE: 257mm(adjustable +-3mm)
HEX TO HEX WIDTH : F177mm / R171mm
CASTER: Adjustable 6/ 8/ 10/ 12 degrees
CAMBER : Adjustable 0 to -12 degrees
DRIVE MODE: RWD
FULL BALL BEARING
TRANSMISSION SYSTEM
HYDRAULIC DAMPER SET



www.rc-mst.com

※ SPECIFICATION ARE SUBJECT TO CHANGE WITHOUT NOTICE

RMX 2.5 RTR

1/10 SCALE RC RWD HIGH PERFORMANCE DRIFT CAR



Appreciate for your choice of RMX 2.5 RTR! You will be impressed with its performance and beauty. Please prepare additional parts as car battery, transmitter battery, and charger. Please follow the process for assemble and setting of parts package. If you have doubt or need assistance, please contact the purchased shop or hobby shop for help, many thanks!

首先感謝你購入 RMX 2.5 RTR 這項產品，您將擁有一部兼具性能與美型的甩尾車。在首次操作前，有以下幾項須要另行購置的物件；車用電池、遙控器用電池、充電器。備妥上述物件後，請進行零件包安裝與設定。如需其他協助，請向原購買店家，或遙控模型店詢問！謝謝！

PLEASE FOLLOW BELOW OPERATIONS BEFORE ASSEMBLING THE PARTS PACKAGE.

請於安裝零件包之前，執行以下操作

PLEASE FOLLOW THE STEPS WHEN STARTING UP.

開機請遵循以下步驟



- | | |
|---|---|
| <ol style="list-style-type: none"> 1 Install transmitter batteries. 2 Loosen receiver antenna. 3 Connector ESC and battery. 4 Turn on the remote controller. 5 Turn on the ESC. 6 Hold the car 3 seconds to wait for the MGX GYRO indicator light to flash from red to green to complete the gyro boot process. | <ol style="list-style-type: none"> 1 安裝遙控器電池 2 鬆開接收機天線 3 聯結車用電池與電子變速器 4 打開遙控器開關 5 打開ESC開關 6 靜置3秒等待MGX GYRO指示燈從紅燈快閃轉為綠燈，即完成陀螺儀開機程序 |
|---|---|

- ※ Please play this product in opening safe area. 請於空曠或安全無虞的場所，使用本項產品。
- ※ The default setting had been completed. 出廠時，基本設定已設定完成。
- ※ RMX 2.5 RTR electronics (Transceiver set/ESC/Gyro) are set by factory and can be directly used after attaching battery. Please refer to instructions for adjusting. RMX 2.5 RTR 之電子設備 (遙控器組/電子變速器/陀螺儀) 已經過原廠設定，玩家可於安裝電池後立即使用；如需依個人習慣調整時，再翻閱說明書。

Gyro sensitivity adjustment way
陀螺儀敏感度調整方向

- ※ Reduce resistance of LIMIT GAIN if the front-wheel wobbly easily on the high grabbing force field. 場地抓地力好導致前輪容易搖擺抖動，可在LIMIT GAIN逆時針微調降低敏感度。
- ※ Fine-tuning clockwise LIMIT GAIN sensitivity to improve car spinning on the poor grabbing force site. 場地抓地力差容易過用SPIN，可在LIMIT GAIN順時針微調提升敏感度。



※ Please refer to transmitter & receiver performance instructions. 遙控器&接收機功能說明請參閱詳細說明書。

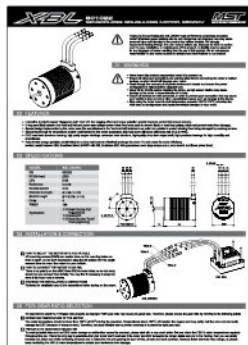

※ Please refer to ESC performance instructions. 電子變速器功能說明請參閱詳細說明書。

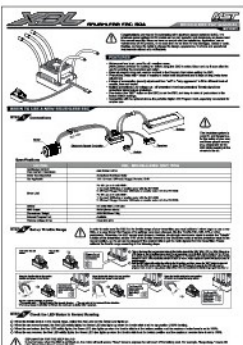

※ Please refer to MGX GYRO performance instructions. 陀螺儀功能說明請參閱詳細說明書。

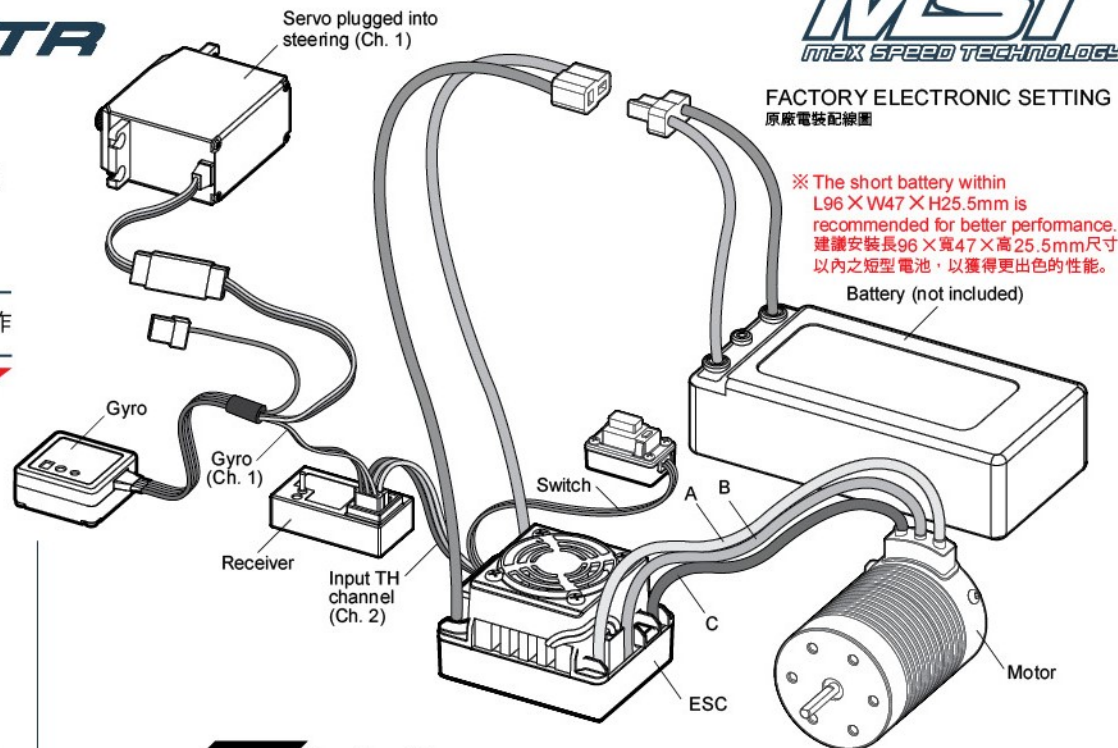

STEP 1 Pasting Sponge

貼上吸震泡棉

※ Please cut along the dashed line. 請沿虛線剪開。

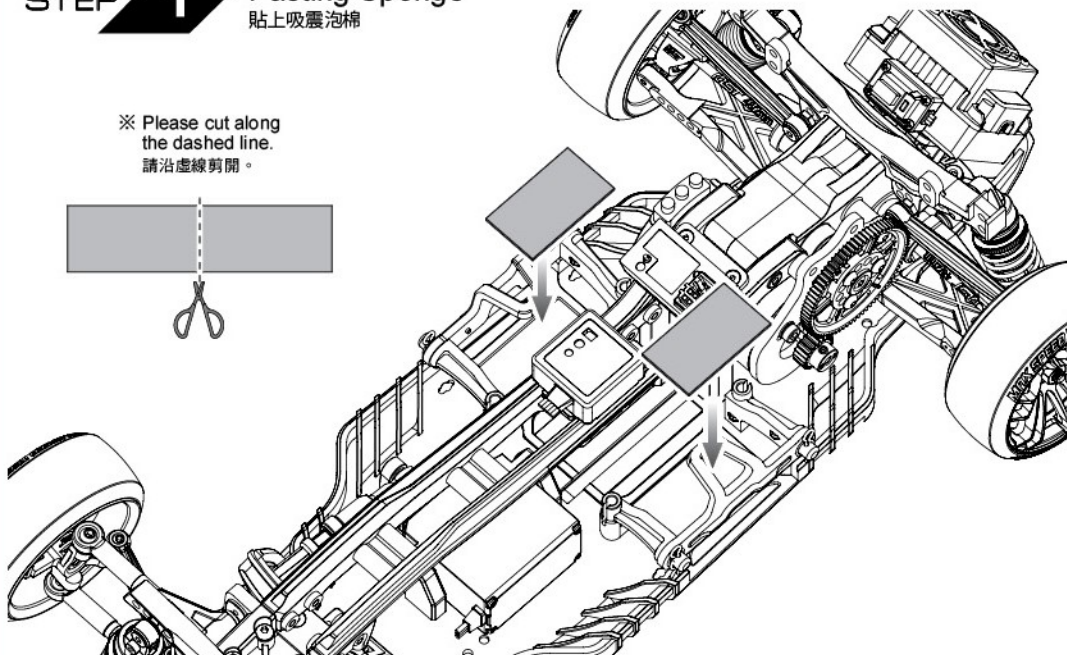

BRUSHED POWER ELECTRONIC SETTING

有刷版原廠電裝配線圖

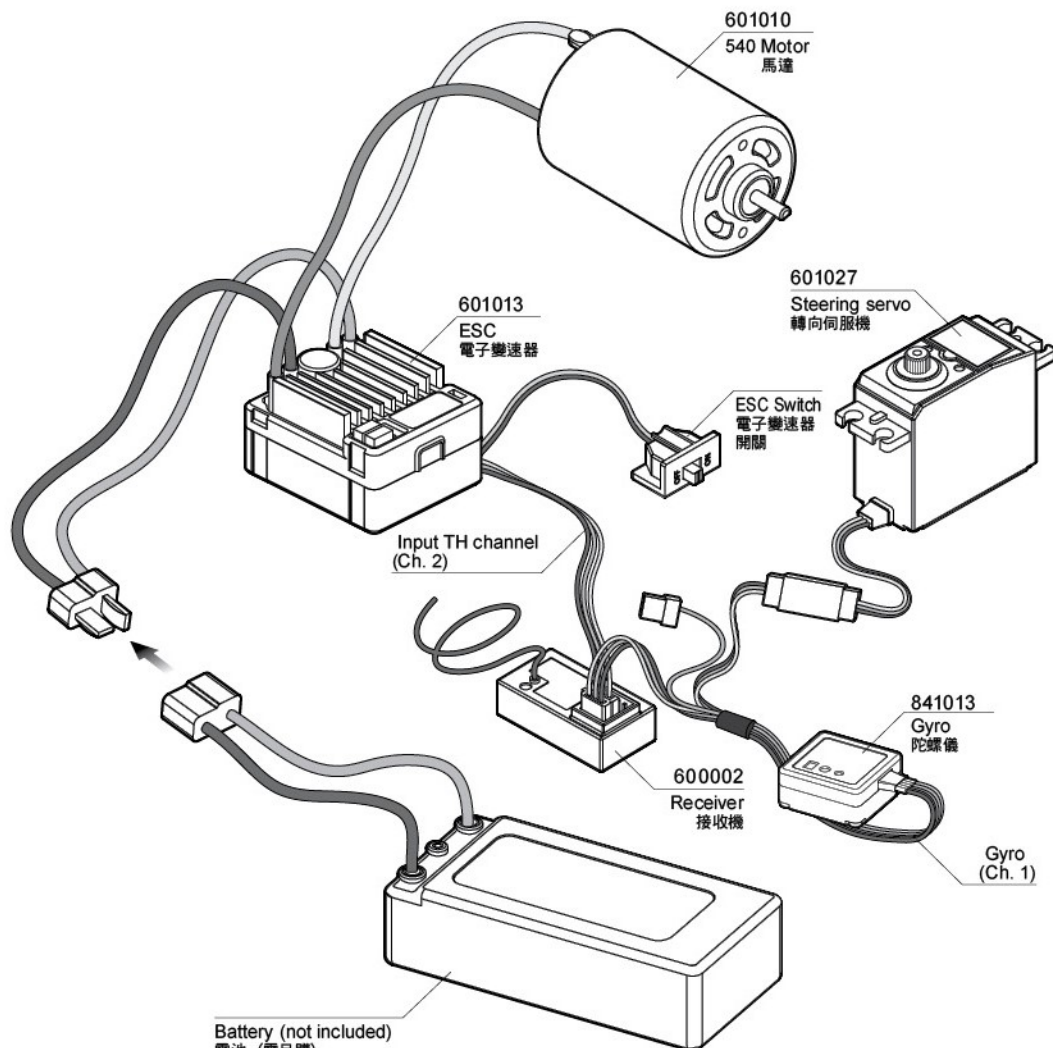

※ The short battery within L96 × W47 × H25.5mm is recommended for better performance.
建議安裝長96 × 寬47 × 高25.5mm尺寸以內之短型電池，以獲得更出色的性能。

PLEASE FOLLOW BELOW OPERATIONS BEFORE ASSEMBLING THE PARTS PACKAGE.

請於安裝零件包之前，執行以下操作

PLEASE FOLLOW THE STEPS WHEN STARTING UP.

開機請遵循以下步驟



- | | |
|---|---|
| ① Install transmitter batteries. | ① 安裝遙控器電池 |
| ② Loosen receiver antenna. | ② 鬆開接收機天線 |
| ③ Connector ESC and battery. | ③ 聯結車用電池與電子變速器 |
| ④ Turn on the remote controller. | ④ 打開遙控器開關 |
| ⑤ Turn on the ESC. | ⑤ 打開ESC開關 |
| ⑥ Hold the car 3 seconds to wait for the MGX GYRO indicator light to flash from red to green to complete the gyro boot process. | ⑥ 靜置3秒等待MGX GYRO指示燈從紅燈快閃轉為綠燈，即完成陀螺儀開機程序 |

※ Please play this product in opening safe area.
請於空曠或安全無虞的場所，使用本項產品。

※ The default setting had been completed.
出廠時，基本設定已設定完成。

※ RMX 2.5 RTR electronics (Transceiver set/ESC/Gyro) are set by factory and can be directly used after attaching battery. Please refer to instructions for adjusting.
RMX 2.5 RTR 之電子設備(遙控器組/電子變速器/陀螺儀)已經過原廠設定，玩家可於安裝電池後立即使用；如需依個人習慣調整時，再翻閱說明書。

Gyro sensitivity adjustment way
陀螺儀感度調整方向

※ Reduce resistance of LIMIT GAIN if the front-wheel wobbly easily on the high grabbing force field.
場地抓地力好導致前輪容易搖擺抖動，可在LIMIT GAIN逆時針微調降低感度。

※ Fine-tuning clockwise LIMIT GAIN sensitivity to improve car spinning on the poor grabbing force site.
場地抓地力差容易過甩SPIN，可在LIMIT GAIN順時針微調提升感度。



※ Please refer to transmitter & receiver performance instructions.
遙控器&接收機功能說明請參閱詳細說明書。



※ Please refer to instruction of ESC performance.
遙控器&接收機功能說明請參閱詳細說明書。

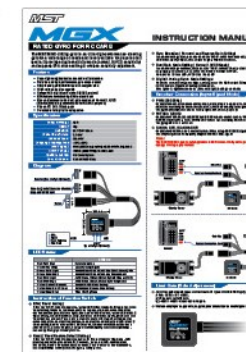

※ Please refer to MGX GYRO performance instructions.
陀螺儀功能說明請參閱詳細說明書。

STEP 2 Attaching Battery 安裝電池

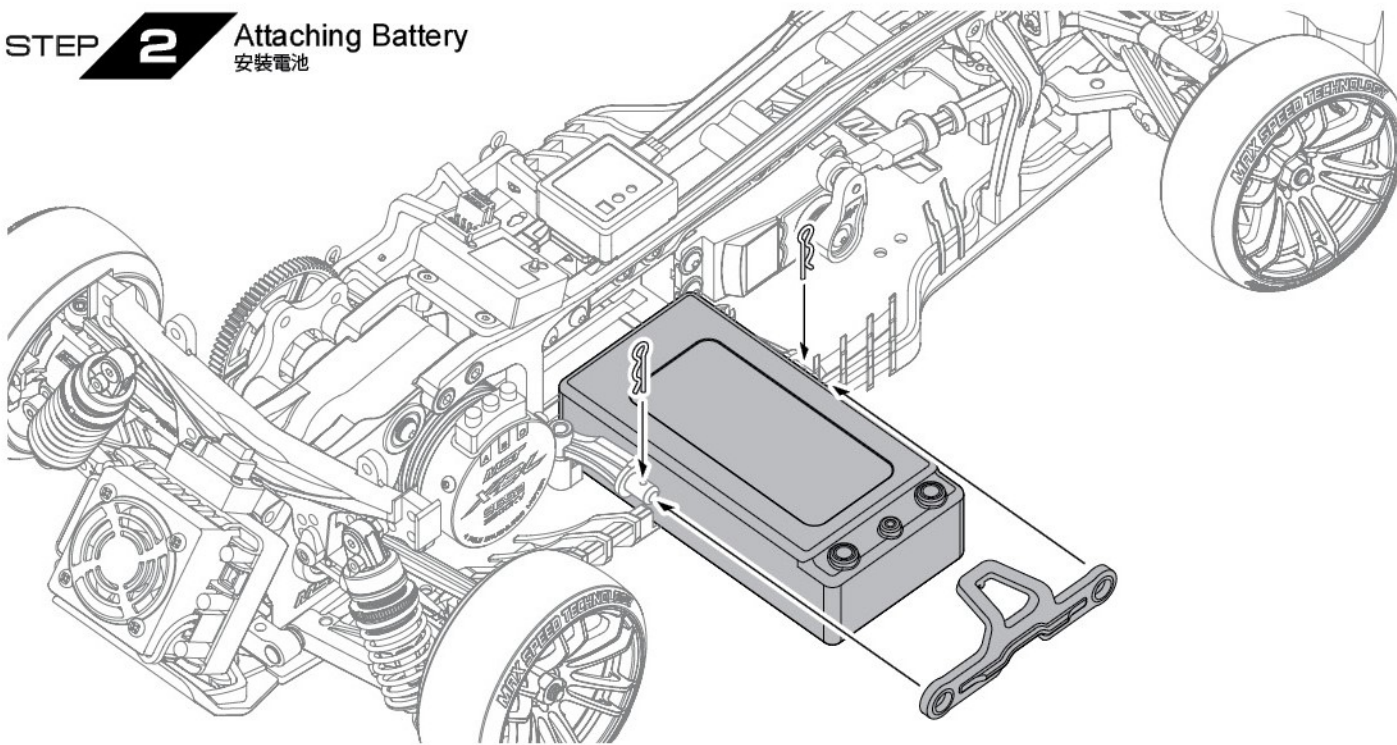

※ The assembly and conservation method may be different by specification of battery.

電池的安裝方式會因為廠牌規格而有些微差異，電池的使用方式與保存方式，也會因電池的種類而有所不同。

※ The short battery within L96×W47×H25.5mm is recommended for better performance.

建議安裝長96×寬47×高25.5mm尺寸以內之短型電池，以獲得更出色的性能。

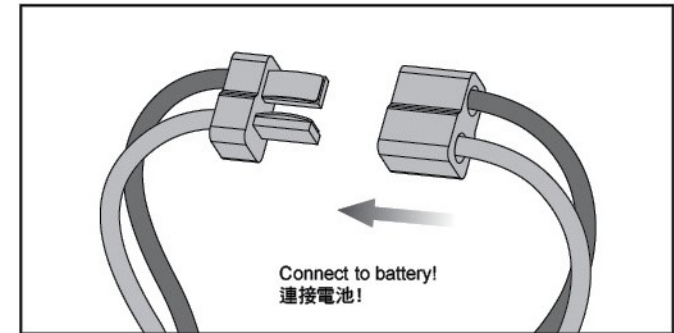

※ Please play in safe place after all setting finish.
Before playing, please switch on transmitter then on the car.
Please switch off reversely.

安裝設定完成後，請於安全場所使用本產品！
使用前請先開啟遙控器電源後再開啟車體電源！
使用後請反向操作關閉！

STEP 3 Attaching Body Mount 車殼浮動架安裝

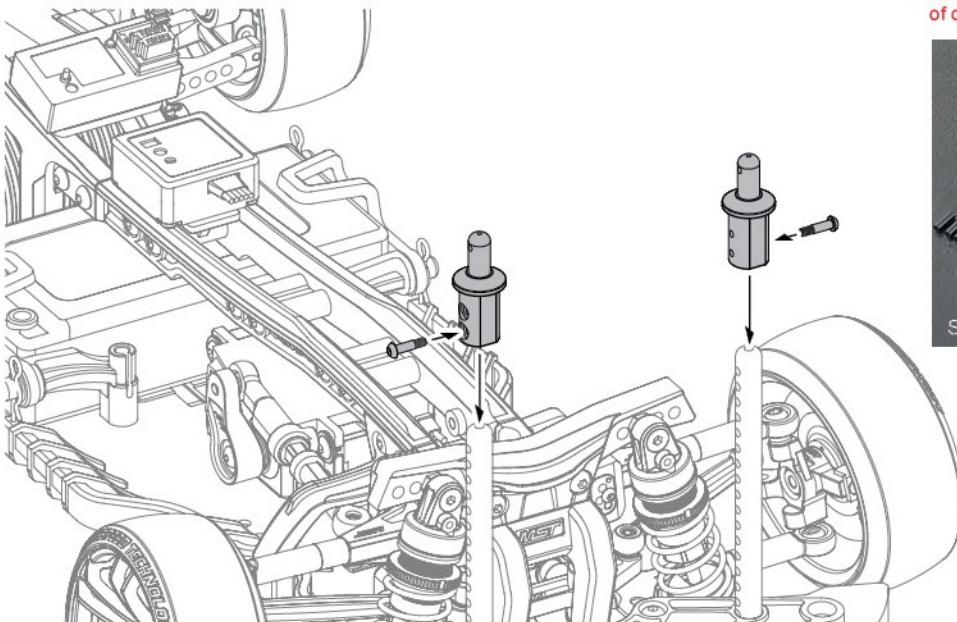

※ Adjust the body mount highness according to the body shell.
依照車殼調整浮動架高度。

※ 820141 Stealth magnetic body post set is recommended to be instead of drilling 5.5mm car shell holes for the car body aesthetics.

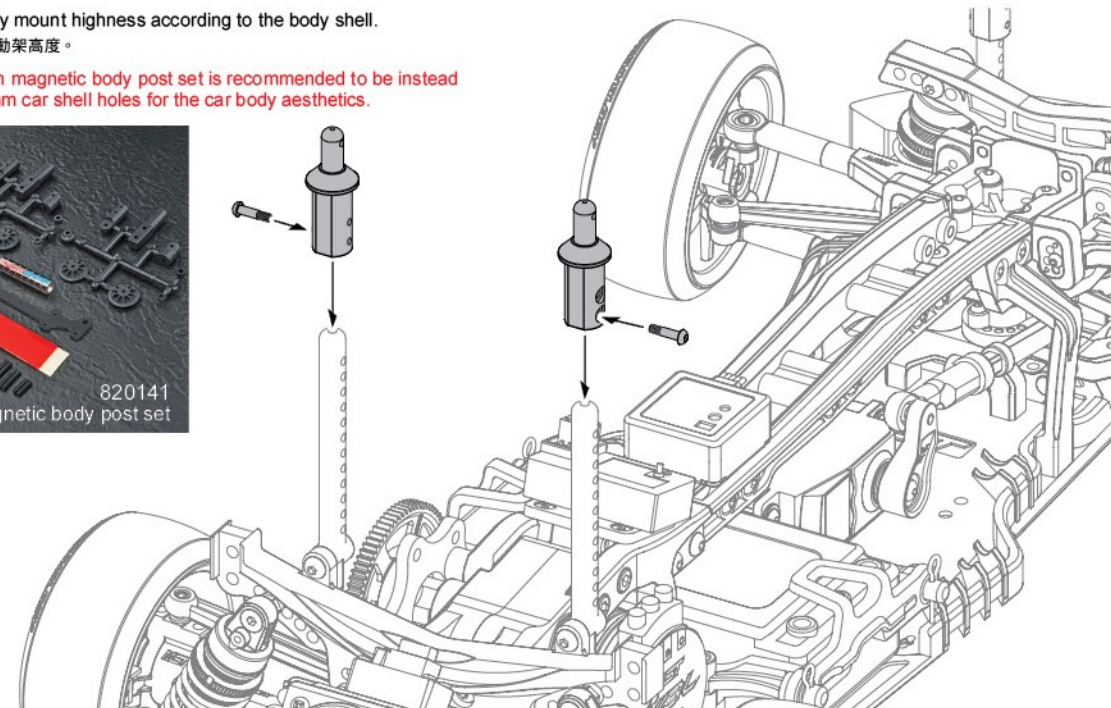

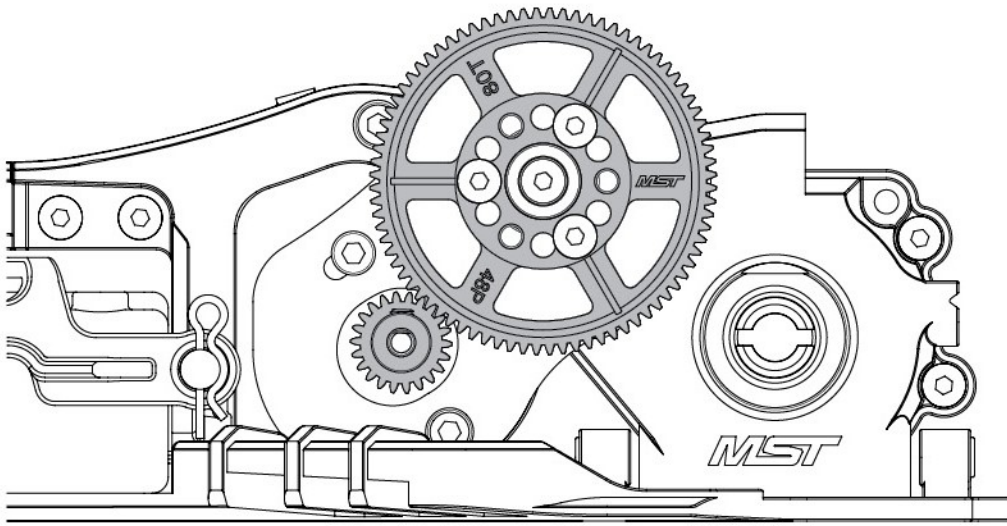

* **FORMULA** (計算公式) $\left(\frac{\text{Spur gear teeth 80T} \text{ 大直齒}}{\text{Pinion gear teeth 馬達齒}} \times \frac{\text{Differential gear 60T} \text{ 差速齒}}{\text{Main shaft gear 20T} \text{ 主軸齒}} \right) = \text{Gear ratio 終傳比}$

GEAR RATIO (For 80T Spur Gear)	
Pinion gear teeth	60T/20T <3.00>
22T	10.91
23T	10.43
24T	10
25T	9.6
26T	9.23
27T	8.89

※Adjust for proper space.
請調整適當齒隙。

CS-R

Dot	Part Number	Recommended Curve	Surface
● Yellow	830001	Common	LOW ↑ Road Grip ↓ HIGH
● Green	830003	Common	
● Red	101024/830002	Common	
● Gold	101025/830009	Common	
● Silver	101026	General	
● Blue	101028	Asphalt	
● PC	101027	Asphalt	
● White	830010	Carpet	

MST
MAX SPEED TECHNOLOGY

026044-1

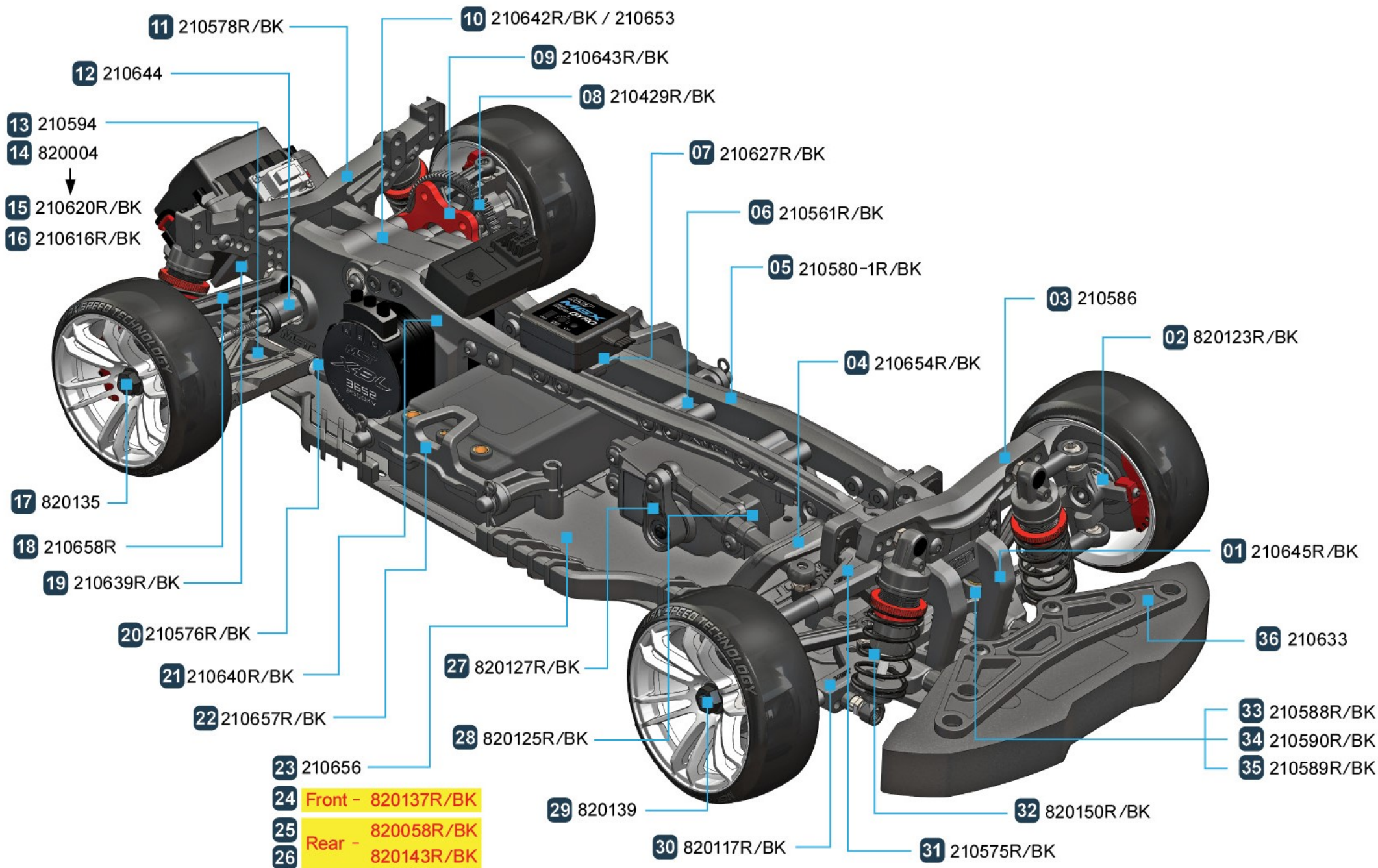



01
210645R/BK
RMX alum. lightweight integrated front head mount



02
820123R/BK
ATK Alum. upright (2WD) (red)

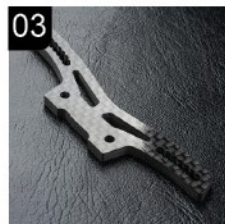

03
210586
RMX 2.0 Carbon front damper stay 3.5

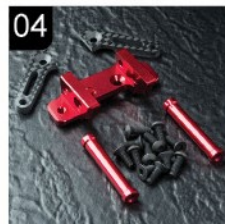

04
210654R/BK
RMX alum. adj. front connect mount v.2 (red)

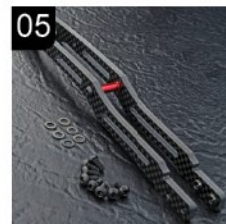

05
210580-1R/BK
RMX 2.0 Carbon upper deck 3.5 (red)



06
210561R/BK
Alum. post M3 X13 (red) (2)



07
210627R/BK
Alum. Gyro mount (red)



08
210429R/BK
RMX Alum. spur gear holder (red)

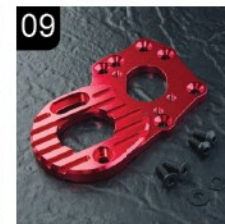

09
210643R/BK
RMX 2.0 alum. spur gearbox motor heat sink mount (red)

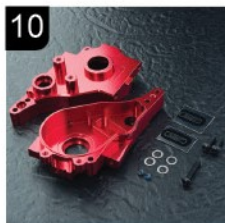

10
210642R/BK
RMX 2.0 alum. spur gearbox set (red)

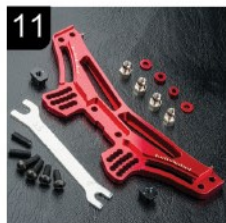

11
210578R/BK
RMX 2.0 Alum. rear damper stay (red)



12
210644
RMX 2.0 alum. spur gear ball diff. set



13
210594
MB Rear suspension kit

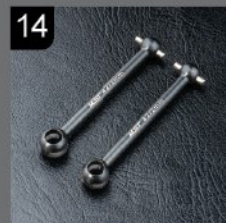

14
820004
Steel CVD great angle universal shaft 42 (2)



15
210620R/BK
MB Alum. Rear upright set (red)

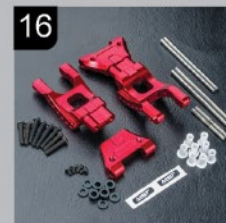

16
210616R/BK
MB Alum. Rear lower arm set (red)



17
820135
Alum. wheel hubs 6mm (large brake disc shaped)

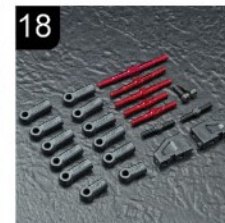

18
210658R
RMX 2.5 RTR turnbuckle shaft set



19
210639R/BK
RMX 2.0 Alum. ESC rear moun set (red)



20
210576R/BK
RMX 2.0 S Alum. suspension mount set (red)

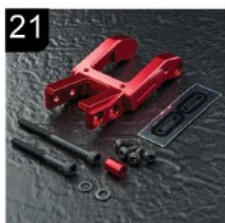

21
210640R/BK
RMX 2.0 alum. integrated upper deck connector (red)

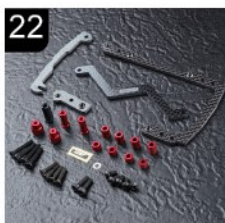

22
210657R/BK
RMX / RRX RS carbon short battery holder set (red)



23
210656
RMX / RRX lightweight flexible carbon deck

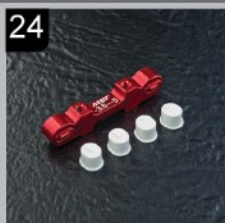

24
820137R/BK **Front**
Adjustable alum. suspension mount (-3.5~-5.0) (red)

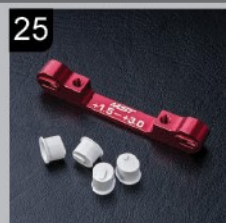

25
820058R/BK **Rear**
Adjustable alum. suspension mount (+1.5~+3.0) (red)

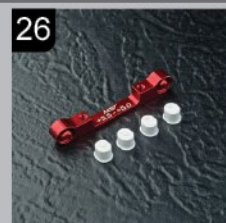

26
820143R/BK **Rear**
Adjustable alum. suspension mount (+3.5~+5.0) (red)

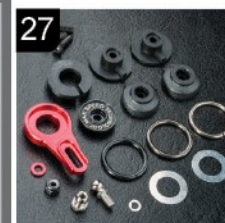

27
820127R/BK
Alum. 8-adjusting servo saver (red)



28
820125R/BK
Alum. servo mount (red)

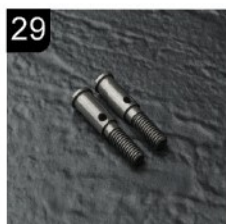

29
820139
Alum. Lightweight 2WD axle (2)



30
820117R/BK
Alum. front lower arm set (red)

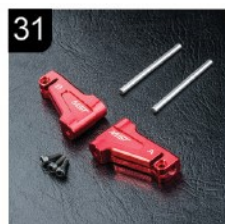

31
210575R/BK
RMX 2.0 Alum. upper arm set (red)

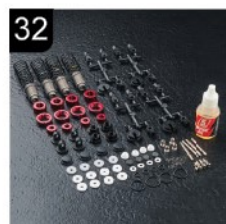

32
820150R/BK
TDA Alum. Drift damper set (red) (4)



33
210588R/BK
Alum. steering arm mount (red)

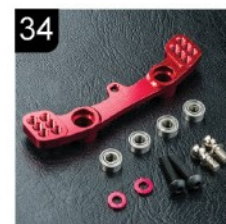

34
210590R/BK
RMX 2.0 Alum. steering joint plate (red)















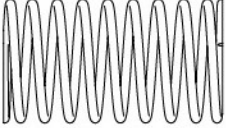
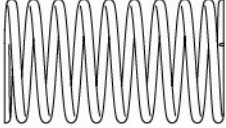







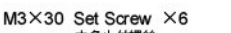



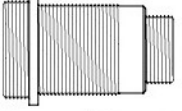
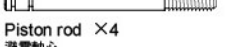









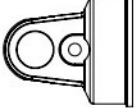















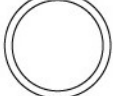









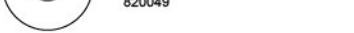



35
210589R/BK
RMX 2.0 Alum. steering arm (red)

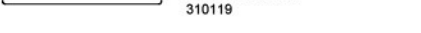

36
210633
Carbon lower bumper 3.0

PARTS

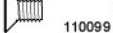
	M2×4 Screw ×8 圓頭螺絲 110004		3×6×0.5 Spacer ×8 墊片 110047		4.8 Ball connector ×7 外六角球頭 210161		M3×3 Screw ×3 止付螺絲 110035		Hard coil spring 31mm ×2 (gold) 硬避震彈簧 31mm (金) 820103		Soft coil spring 31mm ×2 (purple-green) 軟避震彈簧 31mm (紫綠) 820104
	M2×8 Screw ×2 圓頭螺絲 110063		3×8×0.5 Spacer ×1 墊片 110048		4.8 Ball connector L ×2 外六角球頭 (長) 210344		M3×4 Screw ×1 止付螺絲 110083				
	M2×8 Screw ×4 圓頭螺絲 (半牙) 110045		4×6×0.3 Spacer ×4 墊片 820017		4.8×4.5 Ball connector ×8 球頭螺絲 310001		M3×30 Set Screw ×6 六角止付螺絲 110103				
	M3×6 Screw ×5 圓頭螺絲 110001		5×7×0.1 Spacer ×2 墊片 820018		5.8×4 Ball connector L ×4 球頭螺絲 (長) 210491		2×9.8 Shaft ×7 插銷 110017		Damper cylinder ×4 避震筒身 210071		Piston rod ×4 避震軸心 310008
	M3×8 Screw ×26 圓頭螺絲 110002		5×7×0.3 Spacer ×2 墊片 820020		M3×6 Screw ×2 有頭螺絲 (半牙) 110011		2×22 Shaft ×2 插銷 310047				Piston ×4 避震活塞 210235
	M3×10 Screw ×9 圓頭螺絲 110026		3×6×2.5 Bearing ×4 軸承 120024		M3×8 Screw ×4 帶墊片螺絲 110120		2×28 Shaft ×2 插銷 310103		Cylinder cap ×4 避震器上蓋 210057		Damper adjuster ×4 避震器拉桿 820079
	M3×12 Screw ×1 圓頭螺絲 110029		5×8 Bearing ×4 軸承 120017		M3×6 Screw ×2 有頭螺絲 (半牙) 110011		2.5×46 Arm shaft ×4 擺臂插銷 310048				
	M3×14 Screw ×8 圓頭螺絲 110061		4×8×3 Ball bearing ×2 培林 120013		Flange nut M4 ×4 凸緣螺帽 110015		Suspension mount spacer 0.5mm ×2 擺臂座墊片 0.5mm 820063		Rod guide cap ×4 避震器下蓋 210057		10.8×0.9 O-ring ×4 O環 130032
	M3×16 Screw ×1 圓頭螺絲 110086		5×8 Ball bearing ×6 培林 120003		Cross joint ×2 連接軸 820030		Wheel hub spacer 1.0 ×2 輪座墊片 1.0 820049		R-clip 5.0 ×4 R銷 5.0 820075BK		12×1 O-ring ×4 O環 130049
	M3×20 Screw ×2 圓頭螺絲 110088		4×10 Ball bearing ×2 培林 120018		M3×30 Screw ×1 有頭螺絲 (半牙) 110100		4×21 Steel center shaft ×2 鋼製心軸 310119		Damper retainer ×4 避震器彈簧座 820079		
	2.6×10 Screw ×1 自攻圓頭螺絲 110025		10×15 Ball bearing ×4 培林 120001		M3×40 Screw ×3 有頭螺絲 (半牙) 110091		Alum. Main shaft 20T ×1 鋁合金主齒軸 20T 310118		Oil seal ×4 避震器氣室 130004		E-clip ×10 E形扣 110013
	M3×4 screw ×4 沉頭螺絲 110099		5×10 Ball bearing ×2 培林 120002		2WD Axle ×2 二驅輪軸 820095		Wheel axle ×2 萬向接杆 310006		Rod guide ×4 避震器下蓋墊片 210235		Damper O-ring P3 ×4 避震器O環 130028
	M3×8 Screw ×27 沉頭螺絲 110005		5×11 Ball bearing ×2 培林 120011				Steel CVD universal shaft 48 ×2 鋼製CVD傳動軸 48 820136		M3×4 screw ×4 沉頭螺絲 110099		

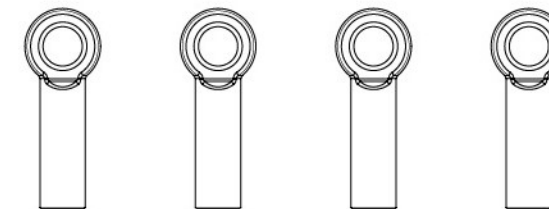
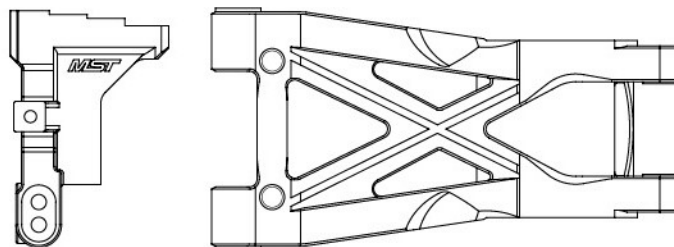
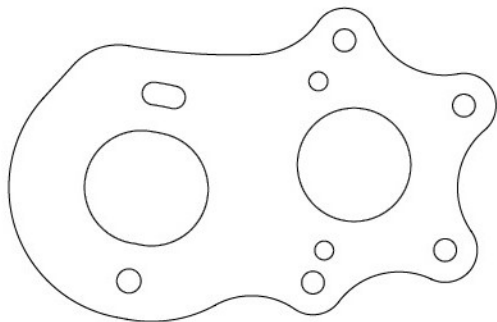
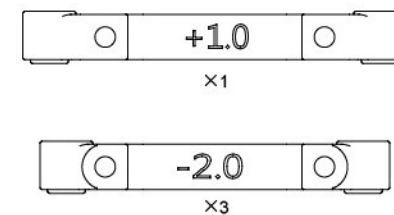
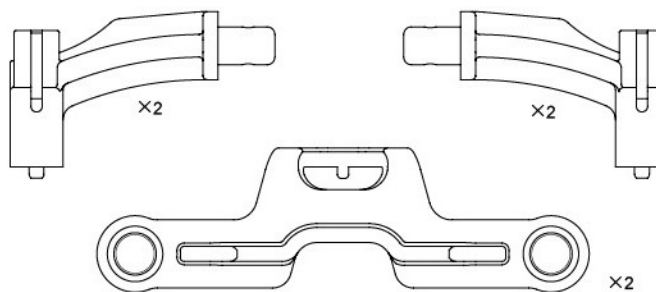
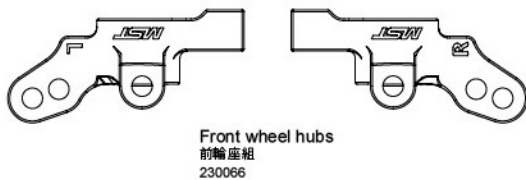
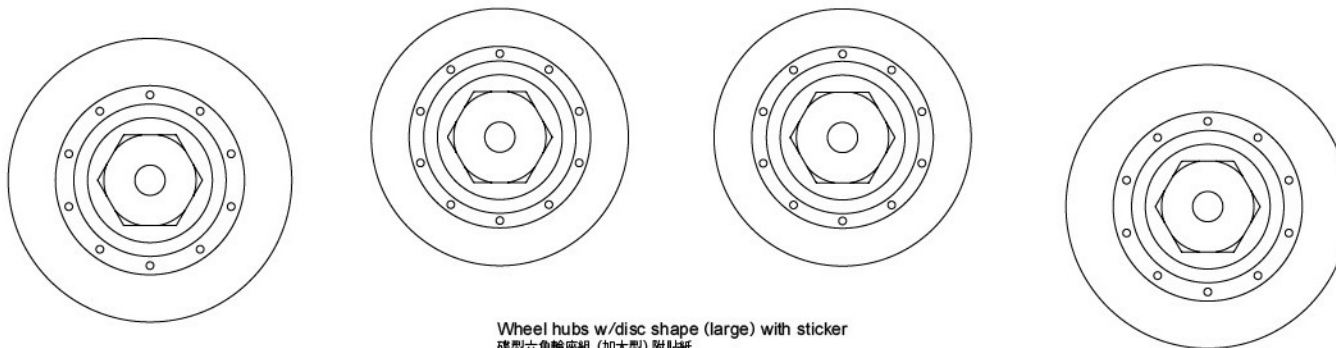
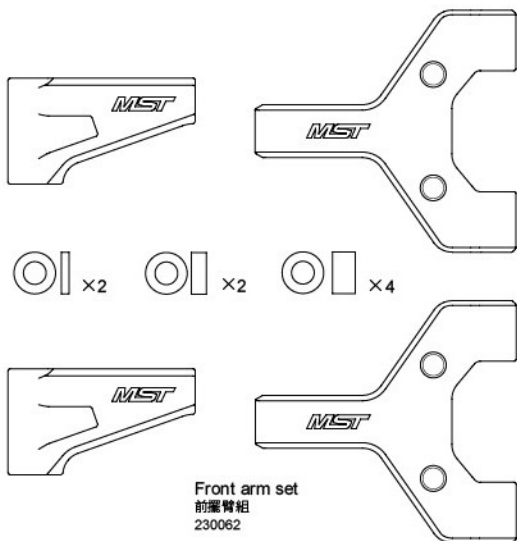

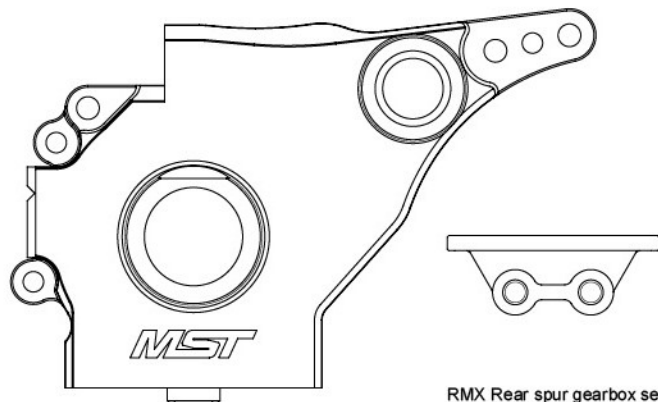

RMX Rear spur gearbox set
 RMX 直齒後齒箱組
 230139

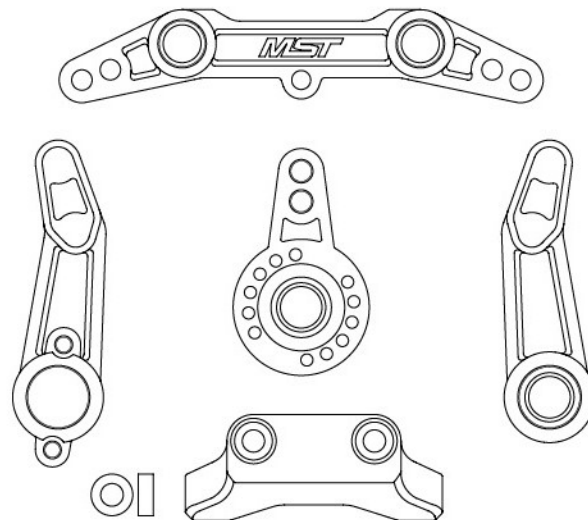
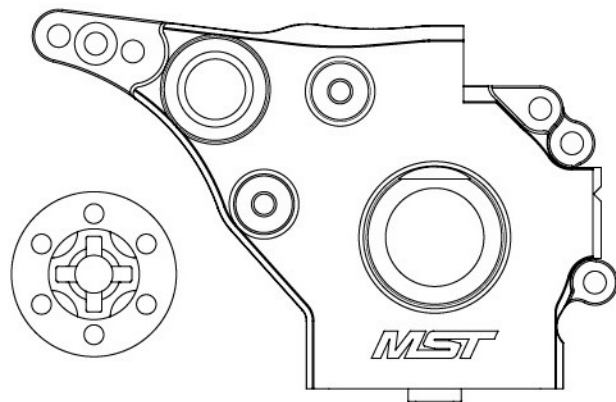

Steering arm set
 轉向搖臂組
 230058

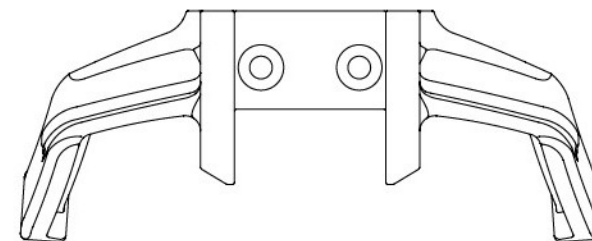

Front head set
 前擋支架組
 230065

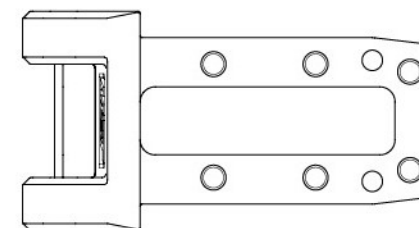
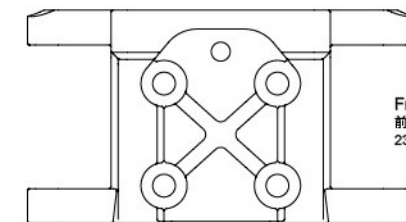

Front damper stay
 前避震架
 230063

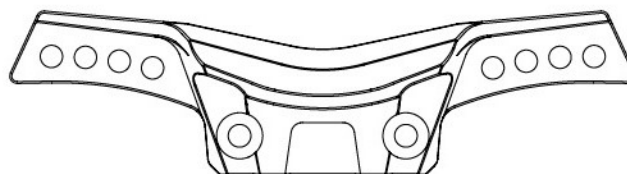

Rear damper stay
 後避震架
 230064



Shaft bush & spacer set
 機套墊片組
 230070BK

Spur gear 48P 80T
 大直齒
 230068

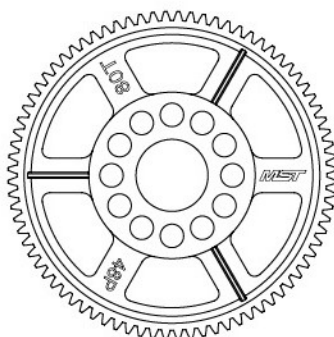

Pinion gear 48P-22T ×1
 馬達齒
 148022P

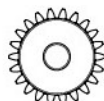

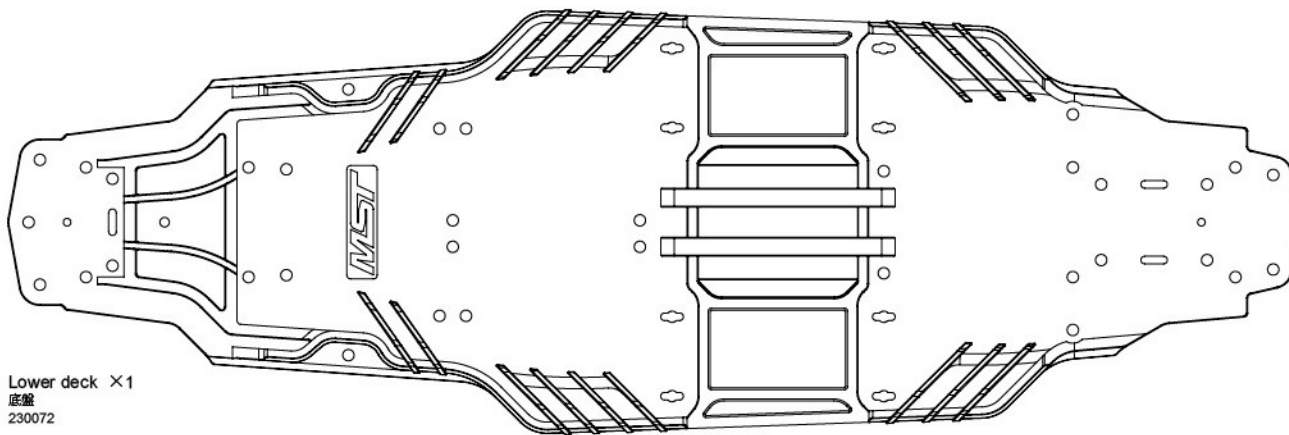

Lower deck ×1
底盤
230072

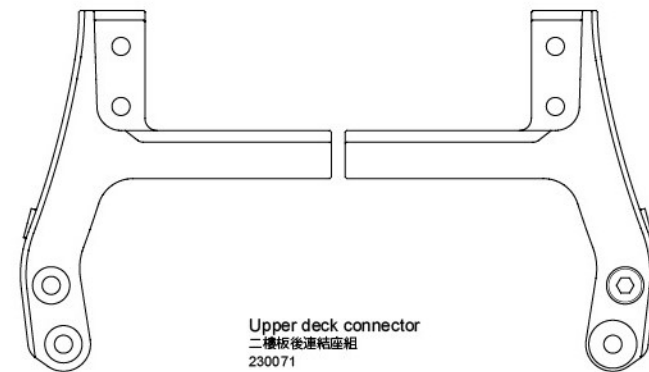

Upper deck connector
二樓板後連結座組
230071

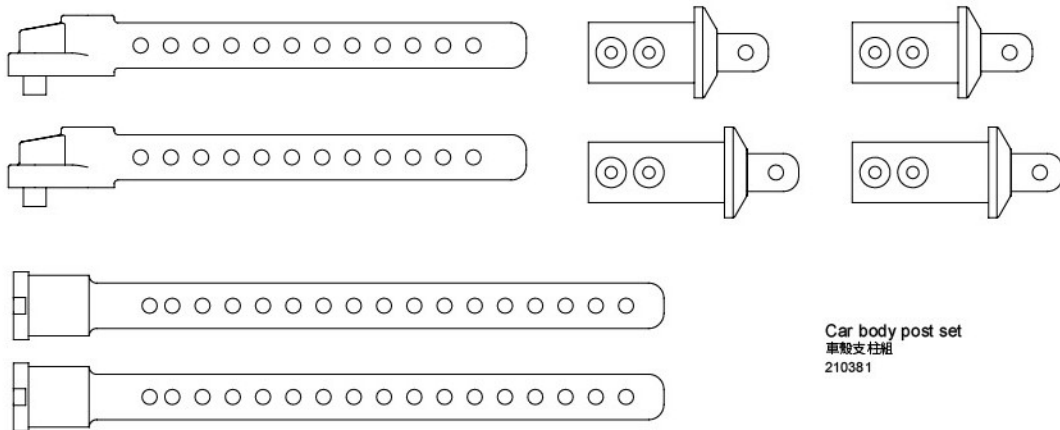

Car body post set
車殼支柱組
210381

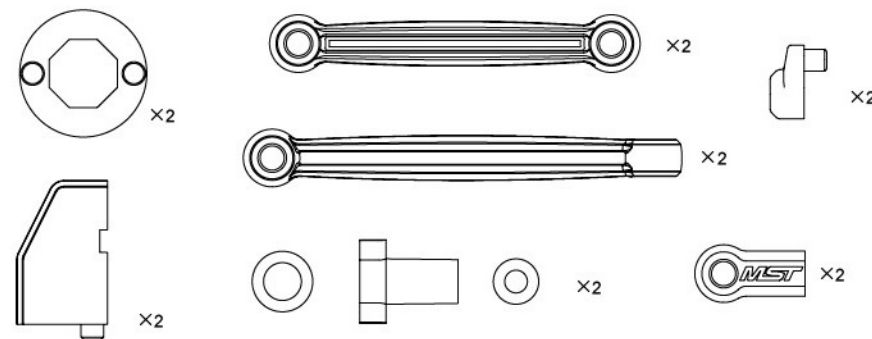

RMX 2.0 RTR fittings
RMX 2.0 RTR 配件組
230092

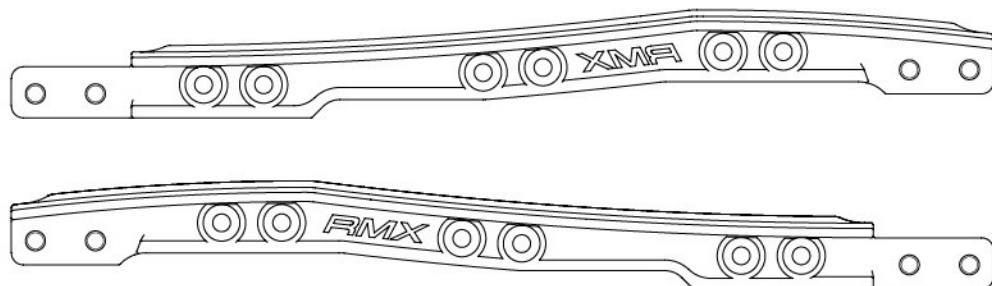

Upper deck set
二樓板組
230073

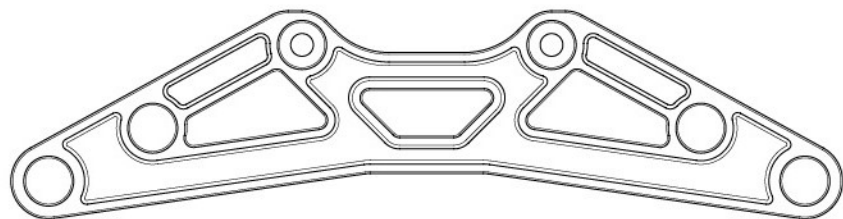

Wide balancing bumper sponge
防撞泡棉
130039

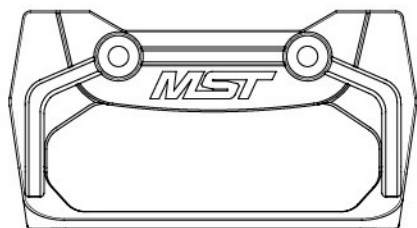
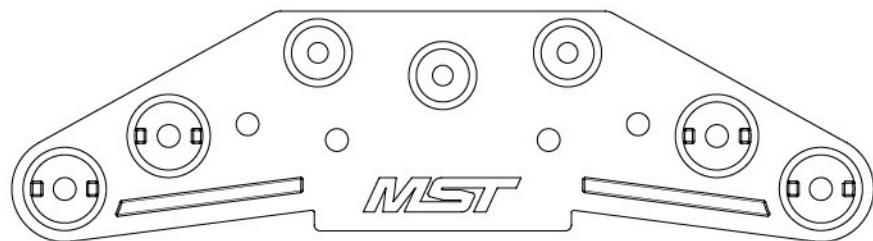

F & R Bumper set
前後防撞板組
230121

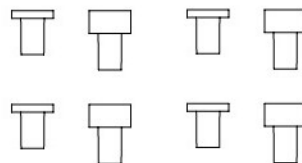

Shaft bush & spacer
set (white)
襯套墊片組 (白)
210063(W)

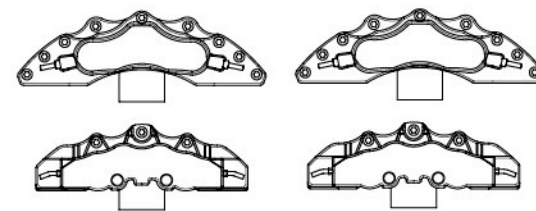

Enlarged brake calipers (red)
加大制車卡鉗 (紅)
210510CR

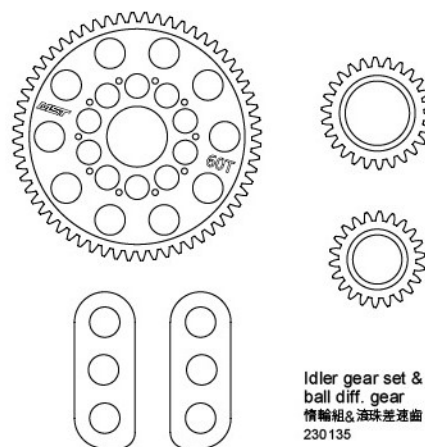

Idler gear set &
ball diff. gear
惰輪組 & 滾珠差速齒
230135

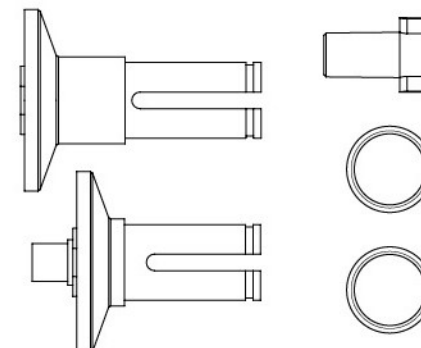

RMX Ball diff. joint
RMX 滾差接杆組
230141

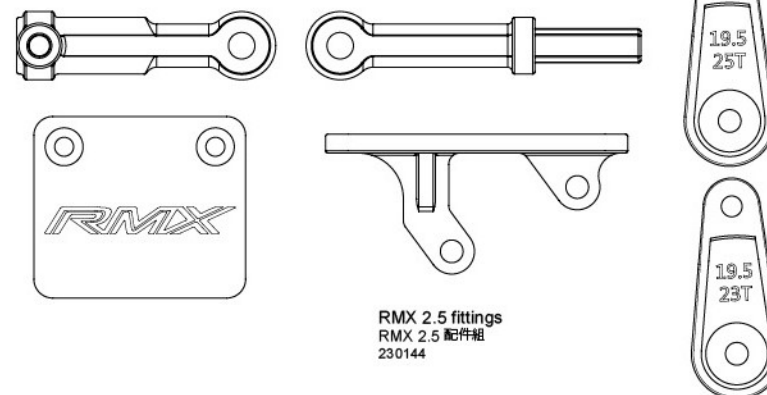
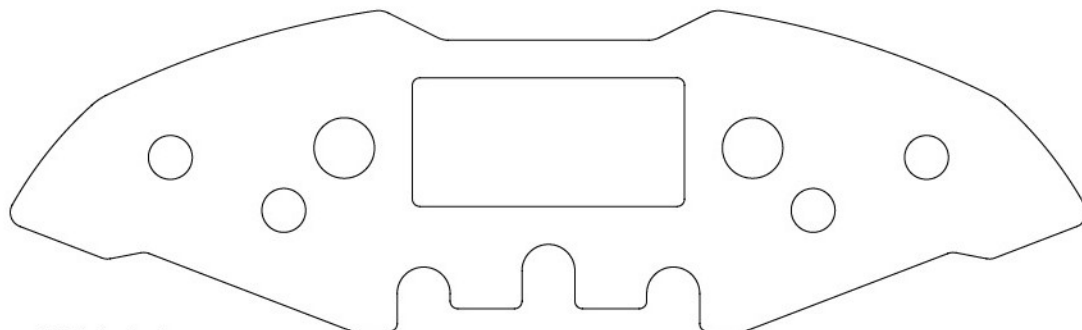

RMX 2.5 fittings
RMX 2.5 配件組
230144

Caster

6°
 8°
 10°
 12°

Front wheel hubs

0/1 mm

Centered

RMX Motor LCG Mode 1

Rear wheel hubs

0 mm

FRONT **REAR**

Tire: _____ Tire: _____

Wheel: _____ Wheel: _____

Offset: **+3/+5** Offset: **+3/+5**

Front damper stay

4 3 2 1

RMX Motor LCG Mode 2

Rear upright

Rear damper stay

5 4 3 2 1

Camber: 6°
Toe-in: -4°

Ride height: 6 mm

RMX Motor HCG Mode

Camber: 2.5°
Toe-in: -3°

Ride height: 5 mm

Front Suspension mount Rollcenter

-2.0 0.5 mm -2.0 0 mm

Steering

Front upright

0 mm 0 mm 0 mm

Rear Suspension mount Rollcenter

-2.0 0 mm +1.0 1 mm

Front lower arm

3 2 1

Rear lower arm

4 3 2 1

Front damper

Shock oil: #10 Spring color: gold
 Spring: 31 mm Ø11 Piston: Ø12 mm Piston hole: 3

Spur Gear ÷ Pinion Gear × Reduction Gear = Gear ratio

80 T ÷ 22 T × 3 = 10.91

Motor & ESC: _____ **Battery:** _____
Transceiver: _____ **Gyro:** _____ **Sensitivity:** _____

Rear damper

Shock oil: #10 Spring color: Purple-green
 Spring: 31 mm Ø11 Piston: Ø12 mm Piston hole: 3

PARTS CODE

110001	Round head screw M3×6 (10)	110100	Cap screw M3×30 (6)	210235	Piston spacer set	230144	RMX 2.5 fittings
110002	Round head screw M3×8 (10)	110101	Countersunk screw M3×20 (6)	210344	Ball connector nut L 4.8 (4)	310001	Ball connector 4.8×4.5 (5)
110004	Round head screw M2×4 (6)	110103	Set screw M3×30 (6)	210381	Car body post set	310006	Wheel axle (2)
110005	Countersunk screw M3×8 (10)	110120	Round head screw w/washer M3×8 (6)	210491	Ball connector L 5.8×4 (4)	310008	Piston rod (4)
110011	Cap screw M3×6 (6)	120001	Ball bearing 10×15 (4)	210510CR	Enlarged brake calipers (red) (4)	310047	Arm shaft 2.0×22 (2)
110013	E-clip 2.0 (10)	120002	Ball bearing 5×10 (4)	230041	Wheel hubs w/disc shape (large)	310048	Arm shaft 2.5×46 (4)
110015	Flange nut M4 (4)	120003	Ball bearing 5×8 (4)	230058	Steering arm set	310103	Arm shaft 2×28 (2)
110017	Shaft 2×9.8 (10)	120011	Ball bearing 5×11 (4)	230060	Battery mount	310106R	Spring retainer (red) (2)
110025	Tapping round head screw 2.6×10 (6)	120013	Ball bearing 4×8×3 (2)	230062	Front arm set	310118	Alum. main shaft 48P 20T
110026	Round head screw M3×10 (10)	120017	Bearing 5×8 (4)	230063	Front damper stay	310119	4X21 Steel center shaft (2)
110029	Round head screw M3×12 (6)	120018	Ball bearing 4×10×4 (2)	230064	Rear damper stay	310122R	RMX Alum. spur gearbox motor mount (red)
110035	Set screw M3×3 (6)	120024	Bearing 3×6×2.5 (4)	230065	Front head set	820017	Spacer 4×6×0.3 (8)
110043	Countersunk screw M3×12 (10)	130004	Oil seal (4)	230066	ATK Front wheel hubs	820018	Spacer 5×7×0.1 (8)
110045	Round head screw M2×8 (partial thread) (6)	130032	Damper cap O-ring (10)	230068	Spur gear 48P-80T	820020	Spacer 5×7×0.3 (8)
110047	Spacer 3×6×0.5 (8)	130039	Wide balancing bumper sponge	230069	Suspension mount set (+1.0/-2.0)	820030	Cross joint (2)
110048	Spacer 3×8×0.5 (8)	130049	O-ring 12×1 (4)	230070BK	Shaft bush & spacer set	820049	Wheel hub spacer 1.0 (4)
110052	Countersunk screw M3×10 (10)	130028	Damper O-ring P3 (blue) (10)	230071	Upper deck connector	820063	Suspension mount spacer 0.5mm (4)
110061	Round head screw M3×14 (6)	148022P	MST 48P Pinion 22T	230072	RMX Lower deck	820075BK	R-clip 5.0 (black) (10)
110063	Round head screw M2×8 (6)	210031	Reinforced adjuster set 5.8×26	230073	RMX Upper deck set	820079	Damper plastic maintenance set (2)
110083	Set screw M3×4 (6)	210057	Damper cap set	230092	RMX 2.0 RTR fittings	820095	AKM 2WD axle (2)
110086	Round head screw M3×16 (6)	210063W	Shaft bush & spacer set (white)	230121	F & R Bumper set	820103	31mm Hard coil spring set (8)
110088	Round head screw M3×20 (6)	210070-1	HT Rear lower arm (4 holes) & wheel hub	230135	Idler gear set & ball diff. gear	820104	31mm Soft coil spring set (8)
110091	Cap screw M3×40 (6)	210071	Damper cylinder (2)	230139	RMX Rear spur gearbox set	820136	Steel CVD universal shaft 48 (2)
110099	Countersunk screw M3×4 (10)	210161	Ball connector nut 4.8 (4)	230141	RMX ball diff. joint (spur)		

部品編號

110001	六角半圓頭螺絲 M3×6 (10)	110100	六角有頭螺絲 M3×30 (半牙) (6)	210235	避震器活塞墊片組	230144	RMX 2.5 配件組
110002	六角半圓頭螺絲 M3×8 (10)	110101	六角沉頭螺絲 M3×20 (6)	210344	球頭螺帽 L 4.8 (4)	310001	內六角球頭 4.8×4.5 (5)
110004	六角半圓頭螺絲 M2×4 (6)	110103	六角止付螺絲 M3×30 (6)	210381	車殼支柱組	310006	萬向接杯 (2)
110005	六角沉頭螺絲 M3×8 (10)	110120	六角半圓頭帶墊片螺絲 M3×8 (6)	210491	球頭螺絲 L 5.8×4 (4)	310008	避震軸心 (4)
110011	六角有頭螺絲 M3×6 (半牙) (6)	120001	培林 10×15 (4)	210510CR	加大煞車卡鉗 (紅) (4)	310047	擺臂插銷 2.0×22 (2)
110013	E扣 2.0 (10)	120002	培林 5×10 (4)	230041	碟型六角輪座組 (加大型)	310048	擺臂插銷 2.5×46 (4)
110015	凸緣螺帽 M4 (4)	120003	培林 5×8 (4)	230058	轉向搖臂組	310103	擺臂插銷 2×28 (2)
110017	插銷 2×9.8 (10)	120011	培林 5×11 (4)	230060	電池座組	310106R	避震調整環 (紅) (2)
110025	自攻六角半圓頭螺絲 2.6×10 (6)	120013	培林 4×8×3 (2)	230062	前擺臂組	310118	鋁合金主齒軸 48P 20T
110026	六角半圓頭螺絲 M3×10 (10)	120017	軸承 5×8 (4)	230063	前避震架	310119	4×21 鋼製心軸 (2)
110029	六角半圓頭螺絲 M3×12 (6)	120018	培林 4×10×4 (2)	230064	後避震架	310122R	RMX 鋁合金直齒箱馬達座 (紅)
110035	六角止付螺絲 M3×3 (6)	120024	軸承 3×6×2.5 (4)	230065	前擴支架組	820017	墊片 4×6×0.3 (8)
110043	六角沉頭螺絲 M3×12 (10)	130004	避震氣室 (4)	230066	ATK前輪座組	820018	墊片 5×7×0.1 (8)
110045	六角半圓頭螺絲 M2×8 (半牙) (6)	130032	避震上蓋O環 (10)	230068	大齒盤 48P-80T	820020	墊片 5×7×0.3 (8)
110047	墊片 3×6×0.5 (8)	130039	寬形配重防撞泡棉	230069	下擺臂座組 (+1.0/-2.0)	820030	連接軸 (2)
110048	墊片 3×8×0.5 (8)	130049	O環 12×1 (4)	230070BK	襯套墊片組	820049	輪座墊片 1.0 (4)
110052	六角沉頭螺絲 M3×10 (10)	130028	阻尼器O環 P3 (藍) (10)	230071	二樓板後連結座組	820063	擺臂座墊片 0.5mm (4)
110061	六角半圓頭螺絲 M3×14 (6)	148022P	MST 48P 馬達齒 22T	230072	RMX 底盤	820075BK	R銷 5.0 (黑) (10)
110063	六角半圓頭螺絲 M2×8 (6)	210031	強化拉桿頭組 5.8×26	230073	RMX 二樓板組	820079	避震膠件包 (2)
110083	六角止付螺絲 M3×4 (6)	210057	避震器上下蓋組	230092	RMX 2.0 RTR 配件組	820095	AKM 二驅輪軸 (2)
110086	六角半圓頭螺絲 M3×16 (6)	210063W	襯套墊片組 (白)	230121	前後防撞板組	820103	31mm 硬避震彈簧組 (8)
110088	六角半圓頭螺絲 M3×20 (6)	210070-1	HT 後下擺臂 (4孔) & 輪座	230135	惰輪組&滾珠差速齒	820104	31mm 軟避震彈簧組 (8)
110091	六角有頭螺絲 M3×40 (半牙) (6)	210071	避震器筒身 (2)	230139	RMX 直齒式後齒箱組	820136	鋼製CVD傳動軸 48 (2)
110099	六角沉頭螺絲 M3×4 (10)	210161	球頭螺帽 4.8 (4)	230141	RMX 滾差接杯組 (直齒用)		

026257