



NX10

10-Channel 2.4GHz
DSMX® Aircraft System



Bind-N-Fly. Ready to fly. redefined.



Instruction Manual
Bedienungsanleitung
Manuel d'utilisation
Manuale di Istruzioni



NOTICE

All instructions, warranties and other collateral documents are subject to change at the sole discretion of Horizon Hobby, LLC. For up-to-date product literature, visit horizonhobby.com or towerhobbies.com and click on the support or resources tab for this product.

Meaning of Special Language

The following terms are used throughout the product literature to indicate various levels of potential harm when operating this product:

WARNING: Procedures, which if not properly followed, create the probability of property damage, collateral damage and serious injury OR create a high probability of superficial injury.

CAUTION: Procedures, which if not properly followed, create the probability of physical property damage AND a possibility of serious injury.

NOTICE: Procedures, which if not properly followed, create a possibility of physical property damage AND little or no possibility of injury.



WARNING: Read the ENTIRE instruction manual to become familiar with the features of the product before operating.

Failure to operate the product correctly can result in damage to the product, personal property and cause serious injury.

This is a sophisticated hobby product. It must be operated with caution and common sense and requires some basic mechanical ability. Failure to operate this Product in a safe and responsible manner could result in injury or damage to the product or other property. This product is not intended for use by children without direct adult supervision. Do not attempt disassembly, use with incompatible components or augment product in any way without the approval of Horizon Hobby, LLC. This manual contains instructions for safety, operation and maintenance. It is essential to read and follow all the instructions and warnings in the manual, prior to assembly, setup or use, in order to operate correctly and avoid damage or serious injury.



WARNING AGAINST COUNTERFEIT PRODUCTS: Always purchase from a Horizon Hobby, LLC authorized dealer to ensure authentic high-quality Spektrum product. Horizon Hobby, LLC disclaims all support and warranty with regards, but not limited to, compatibility and performance of counterfeit products or products claiming compatibility with DSM or Spektrum technology.

NOTICE: This product is only intended for use with unmanned, hobby-grade, remote-controlled vehicles and aircraft. Horizon Hobby disclaims all liability outside of the intended purpose and will not provide warranty service related thereto.

Age Recommendation: Not for Children under 14 years. This is not a toy.

Warranty Registration

Visit www.spektrumrc.com today to register your product.

NOTICE: While DSMX technology allows you to use more than 40 transmitters simultaneously, when using DSM2 receivers, DSMX receivers in DSM2 mode or transmitters in DSM2 mode, do not use more than 40 transmitters simultaneously.

General Notes

- Models are hazardous when operated and maintained incorrectly.
- Always install and operate a radio control system correctly.
- Always pilot a model so the model is kept under control in all conditions.
- Please seek help from an experienced pilot or your local hobby store.
- Contact local or regional modeling organizations for guidance and instructions about flying in your area.
- When working with a model, always power on the transmitter first and power off the transmitter last.
- After a model is bound to a transmitter and the model is set up in the transmitter, always bind the model to the transmitter again to establish failsafe settings.

Pilot Safety

- Always make sure all batteries are fully charged before flying.
- Time flights so you can fly safely within the time allotted by your battery.
- Perform a range check of the transmitter and the model before flying the model.
- Make sure all control surfaces correctly respond to transmitter controls before flying.
- Do NOT fly a model near spectators, parking areas or any other area that could result in injury to people or damage to property.
- Do NOT fly during adverse weather conditions. Poor visibility, wind, moisture and ice can cause pilot disorientation and/or loss of control of a model.
- When a flying model does not respond correctly to controls, land the model and correct the cause of the problem.

CHARGING WARNINGS

WARNING: Failure to exercise caution while using this product and comply with the following warnings could result in product malfunction, electrical issues, excessive heat, FIRE, and ultimately injury and property damage.

- **NEVER LEAVE CHARGING BATTERIES UNATTENDED.**
- **NEVER CHARGE BATTERIES OVERNIGHT.**
- Never attempt to charge dead, damaged or wet battery packs.
- Never attempt to charge a battery pack containing different types of batteries.
- Never allow children under 14 years of age to charge battery packs.
- Never charge batteries in extremely hot or cold places or place in direct sunlight.
- Never charge a battery if the cable has been pinched or shorted.
- Never connect the charger if the power cable has been pinched or shorted.
- Never attempt to dismantle the charger or use a damaged charger.
- Always use only rechargeable batteries designed for use with this type of charger.
- Always inspect the battery before charging.
- Always keep the battery away from any material that could be affected by heat.
- Always monitor the charging area and have a fire extinguisher available at all times.

- Always end the charging process if the battery becomes hot to the touch or starts to change form (swell) during the charge process.
- Always connect the positive leads (+) and negative leads (-) correctly.
- Always disconnect the battery after charging, and let the charger cool between charges.
- Always charge in a well-ventilated area.
- Always terminate all processes and contact Horizon Hobby if the product malfunctions.
- Charge only rechargeable batteries. Charging non-rechargeable batteries may cause the batteries to burst, resulting in injury to persons and/or damage to property.
- The USB outlet shall be installed near the equipment and shall be easily accessible.

CAUTION: Always ensure the battery you are charging meets the specifications of this charger. Not doing so can result in excessive heat and other related product malfunctions, which can lead to user injury or property damage.

CAUTION: If at any time during the charging process the battery pack becomes hot or begins to puff, disconnect the battery immediately and discontinue the charge process as batteries can cause fire, collateral damage and injuries.

BEFORE USING YOUR TRANSMITTER



Before going any further, visit the Spektrum Community website at www.spektrumrc.com to register your transmitter and download the latest Spektrum AirWare™ firmware updates. A registration reminder screen occasionally appears until you register your transmitter. When you register your transmitter, the reminder screen does not appear again.

The transmitter comes with a thin, clear plastic film applied to some front panels for protection during shipping. Humidity and use may cause this film to come off. Carefully remove this film as desired.

BOX CONTENTS

- NX10 Transmitter (SPMR10100)
- Manual
- Magnetic USB charge cable
- Magnetic Micro USB charge adapter
- Decal set
- Neck strap

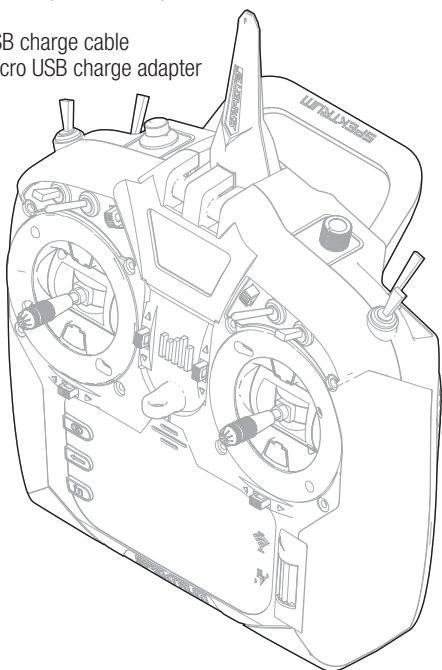

SPECIFICATIONS

Type	DSM2/DSMX 10 CH Telemetry Transmitter
Application	Airplanes, Helicopters, Sailplanes, Multirotors
Channels	10
Wireless Trainer	DSM2*/DSMX Compatible
Switches	2 - 2 Position, 6 - 3 Position, 1 Momentary Button, 2 - Trimmers, 2 - Sliders
Modulation	DSM2*/DSMX
Telemetry	Integrated
Bind Method	Bind Button or From Within Menu
Frame Rate	22ms Default, 11ms Selectable (Digital Servos Required)
Resolution	2048
Battery	3.7V 6,000 mAh Lilon
Band	2.4GHz
Feedback	Tone, Vibration, Voice

* EU versions of the NX10 are not compatible with DSM2® receivers.

For helpful videos on programming the NX10 and other Spektrum AirWare™ equipped transmitters, go to www.spektrumrc.com.

TABLE OF CONTENTS

Table of Contents	4	Exporting the Serial Number to the Memory card	28
Charging the Lithium Ion Battery Pack	5	Locating the Transmitter Spektrum AirWare Software Version	28
Updating with WiFi	5	Function List	29
Transmitter Functions	6	Servo Setup	29
Powering the NX10 On and Off	7	Travel Adjust	29
Main Screen	8	Sub-Trim	29
Navigation	8	Reverse	29
Auto Switch Select	8	Speed	30
Internal Memory	9	Absolute (Abs.) Travel	30
External Memory card	9	Balance	30
Memory card Functions	10	Dual Rates and Expo	30
Update Spektrum AirWare™ Software.....	10	Differential (Acro and Sail Types Only)	30
Model Type Programming Guide	11	Throttle Cut (Acro and Heli Types Only).....	31
System Setup	12	Throttle Curve (Acro and Heli Types Only).....	31
Model Select.....	12	Analog Switch Setup	31
Model Type	12	Digital Switch Setup.....	31
Model Name	13	Mixing	32
F-Mode Setup	13	Normal Mix	32
Flight Mode Setup.....	14	Curve Mix.....	33
Channel Assignment	14	Curve (Page) Advanced Configuration Options.....	33
Channel Input Configuration.....	14	Sequencer	33
Trim Setup	15	Range Test.....	34
Model Utilities	16	Timer.....	35
Create New Model	16	Telemetry	35
Delete Model	16	Forward Programming	35
Copy Model	17	Audio Events.....	36
Model Reset	17	VTX Setup.....	36
Sort Model List	17	Function Bar	36
Validate All Models	17	Bind.....	37
Delete All Models	17	Start Trainer.....	37
Warnings	17	System Setup	37
Telemetry	18	Monitor	37
Telemetry Settings.....	18	ACRO (Airplane)	39
Telemetry Auto-Configuration.....	18	Aircraft Type	39
Telemetry Alarms	18	Recommended Servo Connections.....	39
Preflight Setup	19	Aircraft Options.....	39
Frame Rate	19	Elevon Servo Control.....	40
Bind	19	Flap System.....	40
Serial Port Setup.....	19	ACRO Mixing.....	40
Trainer	20	Differential	41
Wired Trainer	20	V-Tail Differential	41
Wireless Trainer	20	Gyro Menus	41
Instructor Transmitter Configuration.....	21	HELI (Helicopter)	42
Binding Wireless Trainer	21	Swash Type	42
Head Tracking FPV Setup.....	21	Collective Type.....	42
Center Tone	22	Pitch Curve	42
Sound Utilities	22	Swashplate.....	43
Palette Utilities	22	Gyro.....	43
System Settings	22	Tail Curve	43
User Name	22	Mixing	43
Brightness	23	Sail (Sailplane)	44
Mode*	23	Sailplane Type	44
Battery Alarm.....	23	Sailplane Image	44
Selecting a Language.....	23	Camber Preset	44
Inactive Alarm	23	Camber System	44
Extra Settings	24	SAIL Mixing.....	45
System Sounds.....	24	V-Tail Differential	45
Vibrator Intensity Adjustment.....	24	Multi (Multirotor)	46
Trim Style	24	F-Mode Setup.....	46
Volume Controls.....	24	Trim Setup	46
Channel Monitor	24	D/R and Exponential.....	46
Set Date/Time	24	Motor Cut	47
Power Sounds	25	Motor Curve	47
Factory Reset.....	25	Physical Transmitter Adjustments	48
Calibrate.....	25	Adjust Stick Tension.....	48
WiFi Utilities	25	Control Stick Length Adjustment	48
USB Settings	25	Gimbal Travel Limit	48
Transfer Memory Card	26	Ratcheted Throttle – Smooth Throttle Adjustment.....	49
Model Import/Export	26	Antenna Position	49
Import All Models	26	Mode Conversion	49
Memory Location	26	Troubleshooting Guide	50
Export Model	26	1-Year Limited Warranty	51
Importing/Exporting Color Palettes.....	27	Warranty and Service Contact Information	52
Update AirWare	27	FCC Information	52
About / Regulatory	28	IC Information	52
Serial Number	28	Compliance Information for the European Union	53

CHARGING THE LITHIUM ION BATTERY PACK

For optimum charging results, the built-in charger requires a USB power supply capable of at least 2-3A output. Using a power supply with a lower output will result in very long charge times or the transmitter not charging if it is powered on while attempting to charge. The first time the transmitter is charged, the charge time may be 6-7 hours. Charge the transmitter when the low battery alarm sounds. See the System Settings section for information on setting the low battery alarm level.

Always charge the transmitter on a heat-resistant surface.

CAUTION: Never change the low voltage limit for Li-Ion batteries below 3.3V. Doing so could over-discharge the battery and damage both battery and transmitter.

CAUTION: Never leave a charging battery unattended.

CAUTION: Never charge the battery outside of the transmitter. Charging the battery outside of the transmitter may interfere with the battery monitoring system, which can give false low battery warnings.

1. Connect a 2-3A USB power supply (not included) to an AC outlet.
2. Connect the included magnetic USB charging cable to the power supply.
3. Insert the included magnetic micro USB adapter in the USB port on the back of the transmitter.
4. Connect the USB charging cable to the magnetic adapter.
5. The LED will flash blue while charging. A fast press of the power switch will bring the Charge Battery icon to the color touch screen display.
6. Charging is complete when the button is pressed and the battery capacity icon on the screen shows full. Disconnect the USB cable once charging is complete.
Disconnect the power supply from the power outlet.
The magnetic micro USB adapter can be left in the transmitter USB port for future use.

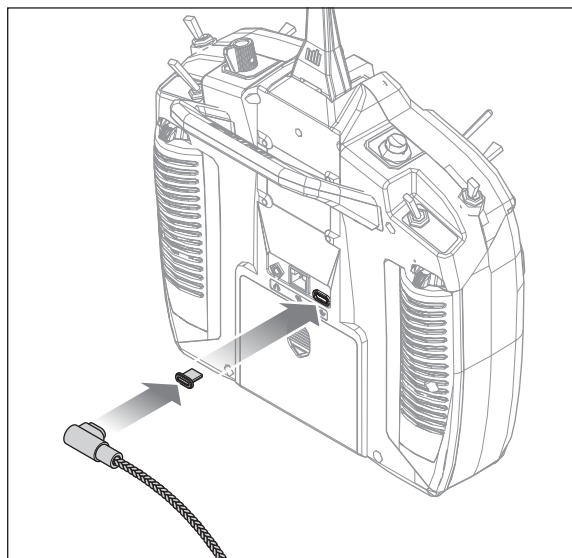

UPDATING WITH WIFI

The NX10 transmitter has a WiFi capabilities to enable you to download updates from the SpektrumRC.com website. You must start an account at SpektrumRC.com first on your PC, Mac, or mobile device before you can connect with your NX10

1. Power ON your NX10 and enter the Function menu, Scroll to the bottom to access the System menu.
2. Scroll down and select Check For Updates. The NX10 will search for WiFi networks in range and display the options for you to connect with.
3. Select your WiFi connection. Load the SSID and password for connection and select Connect.
4. Select Log In and fill in your account information.
5. Select Check For Updates to check for the newest updates on your NX10, and download them automatically.
6. If you wish to erase your registration information from your NX10 you may do so. Otherwise, select Log Out to resume normal operation.

WiFi Credentials LIST

SSID: TheShellFamily
Password:
Auto-Connect: Inh

CONNECT

Spektrum Menu LIST

Log in
Register
Deregister
Check for Updates
Log Out
Erase Credentials

Downloading... BACK

3.00.07
SPMTX.sax



19% Time: 0:28, Speed: 54 kB/s

TRANSMITTER FUNCTIONS

Function	
1	Elevator Trim (Mode 2, 4) Throttle Trim (Mode 1, 3)
2	R Trimmer
3	R Knob
4	Switch E
5	Switch H
6	Switch G
7	Switch F
8	Throttle Tension Adjustment Throttle Ratchet Adjustment (Mode 1, 3)
9	Gimbal Travel Limiter Access Panel
10	Mode Change Screw

Function	
11	Throttle/Aileron Stick (Mode 1) Elevator/Aileron Stick (Mode 2) Throttle/Rudder Stick (Mode 3) Elevator/Rudder Stick (Mode 4)
12	Left/Right Gimbal Stick Tension Adjustment
13	Up/Down Gimbal Stick Tension Adjustment
14	Gimbal Travel Limiter Access Panel
15	Aileron Trim (Mode 1, 2) Rudder Trim (Mode 3, 4)
16	Neck Strap Mount
17	WiFi Indicator
18	Scroll wheel
19	Charge Indicator
20	LCD

Function	
21	Function Button
22	Back Button
23	Clear Button
24	Speaker
25	Rudder Trim (Mode 1, 2) Aileron Trim (Mode 3, 4)
26	Throttle Tension Adjustment Throttle Ratchet Adjustment (Mode 2, 4)
27	Gimbal Travel Limiter Access Panel
28	Mode Change Screw
29	Elevator/Rudder Stick (Mode 1) Throttle/Rudder Stick (Mode 2) Elevator/Aileron Stick (Mode 3) Throttle/Aileron Stick (Mode 4)

Function	
30	Left/Right Gimbal Stick Tension Adjustment
31	Up/Down Gimbal Stick Tension Adjustment
32	Gimbal Travel Limiter Access Panel
33	Switch D
34	Switch B
35	Switch A
36	Switch C
37	L Trimmer
38	Elevator Trim (Mode 1, 3) Throttle Trim (Mode 2, 4)
39	On/Off Switch
40	Antenna

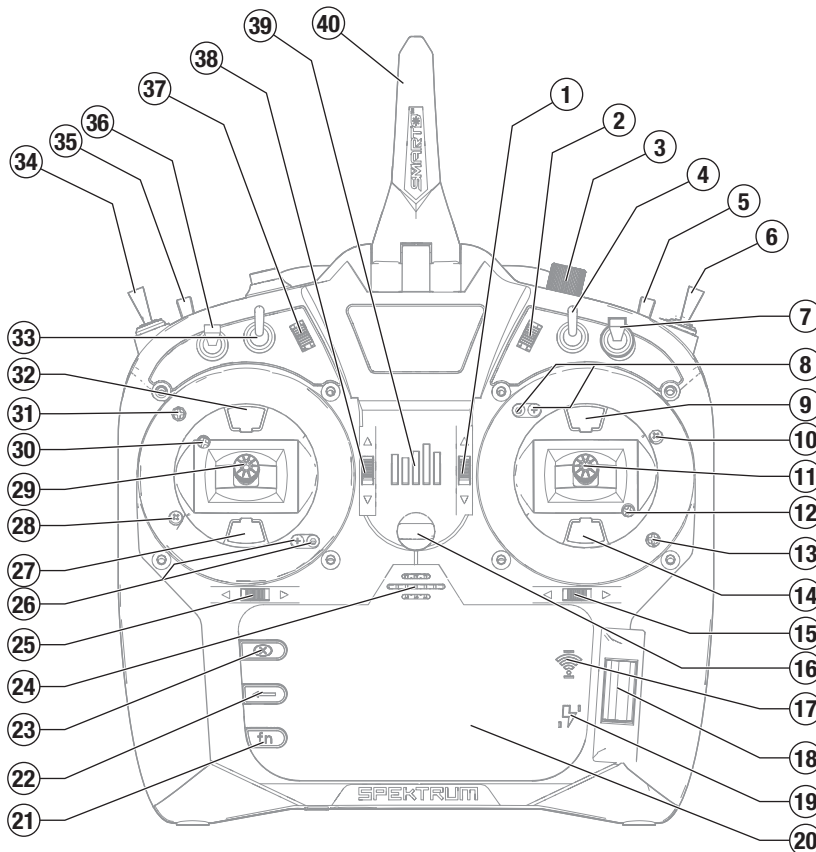

Function	
1	Switch I/ Bind
2	Switch A
3	Left Lever
4	Mounting for CSRF
5	Micro USB Connector
6	Memory Card Opening

Function	
7	Battery Cover
8	Data Port
9	Audio Port
10	Right Lever
11	Switch H
12	Antenna Rotation Tension

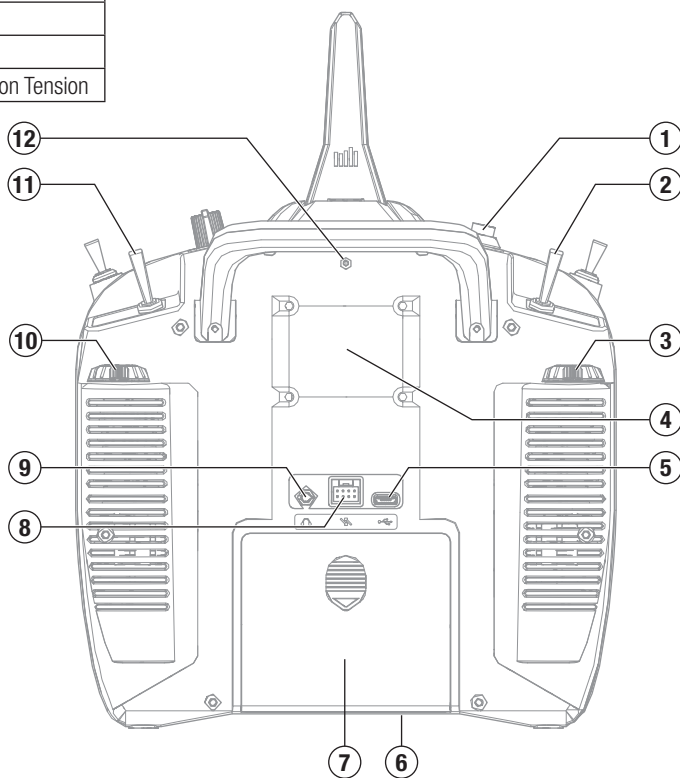

POWERING THE NX10 ON AND OFF

1. Press and hold the Spektrum Logo for several seconds to turn ON the NX10.
2. Press and hold the power button for about 4 seconds to power OFF the NX10.

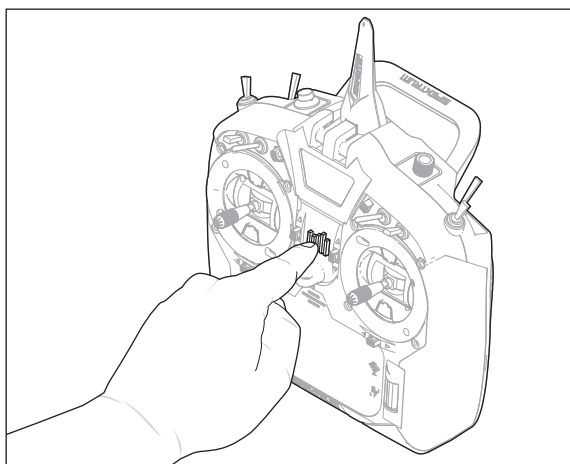

MAIN SCREEN

	Function
1	Model Name
2	DSMX/DSM2 If not shown, this indicates not bound
3	Displays throttle position
4	Digital Battery Voltage (an alarm sounds and the screen flashes when battery charge gets down to 3.2V for a Li Ion battery.)
5	Model Avatar
6	Elevator Trim (Mode 2, 4) Throttle Trim (Mode 1, 3)
7	Aileron Trim (Mode 1, 2) Rudder Trim (Mode 3, 4)
8	Model Memory Timer
9	Rudder Trim (Mode 1, 2) Aileron Trim (Mode 3, 4)

	Function
10	Throttle Trim (Mode 2, 4) Elevator Trim (Mode 1, 3)
11	Timer

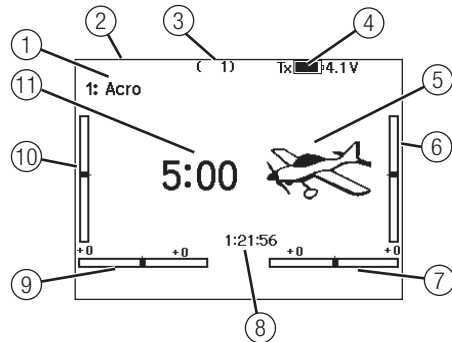

NAVIGATION

- Scroll the scroll wheel to move through the screen content or change programming values. Press the scroll wheel to make a selection.
- Use the Back button to go to the previous screen (for example, to go from the Mixing Screen to the Function List).
- Use the Clear button to return a selected value on a screen to the default setting.
- Direct Model Access enables you to access the Model Select screen without powering off the transmitter. Anytime the transmitter power is on, press the Clear and Back buttons to access the Model Select screen.
- Press and hold the scroll wheel while powering on the transmitter to show the System Setup list. No radio transmission occurs when a System Setup screen is displayed, preventing accidental damage to linkages and servos during changes to programming.
- At the main screen you can scroll to view the servo monitor.
- The Main Screen appears when you power on the transmitter. Press the scroll wheel once to display the Function List.
- When you want to change a value in a screen for a particular control position, move the control to the desired position to highlight the value you want to change, such as 0/1/2, up/down or left/right.

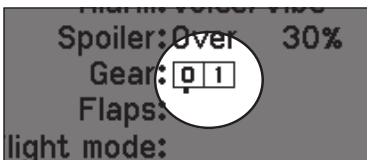

TIP: The tick mark below shows the current switch position. Rolling and clicking the scroll wheel turns the selected box black, indicating that the value or condition will act on that position.

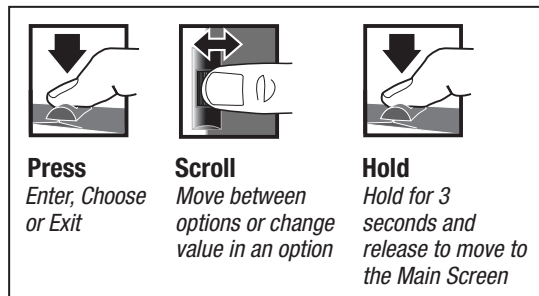

AUTO SWITCH SELECT

To easily select a switch in a function, such as a program mix, roll with the scroll wheel to highlight the switch selection box, and press the scroll wheel. The box around the switch should now flash. To select a switch, toggle the switch you wish to select. Verify the switch selection is now displayed as desired. When correct, press the scroll wheel to select this switch and complete the switch selection.

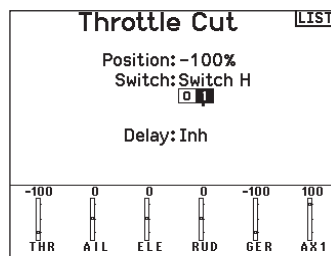

INTERNAL MEMORY

The internal memory may be accessed via the USB port on the transmitter to enable the following tasks:

- Update Spektrum AirWare software in the transmitter
- Install/Update sound files
- Back up models for safe keeping
- Import/Export Color Palettes

To connect to the internal memory:

1. Connect a Micro USB cable to your PC and the micro USB connector on the back of the transmitter.
2. Power ON the transmitter, enter the system menu -> USB storage, select Access Internal Storage, the NX10 will connect to your PC.
3. Complete your file transfer(s).
4. Press the Back button or the roller to exit.
5. Disconnect the USB cable from your transmitter.

EXTERNAL MEMORY CARD

Installing An External Memory Card

A micro memory card (not included) enables you to:

- Import (copy) models from any compatible* Spektrum AirWare™ transmitter
- Export (transfer) models to any Spektrum AirWare transmitter*
- Update Spektrum AirWare software in the transmitter
- Install/Update sound files
- Back up models for safe keeping

To install or remove a Memory card:

1. Power OFF the transmitter.
2. Press the Memory card into the card opening with the card label facing toward the back of the transmitter.

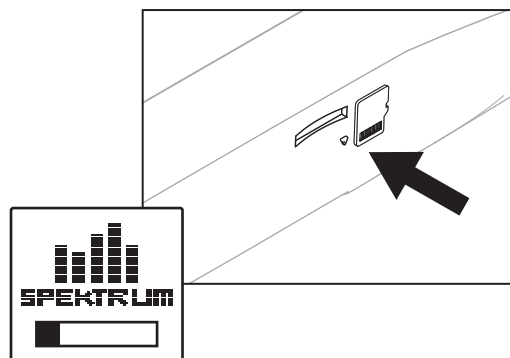

*iX12, iX20, DX20, DX18t, DX18SE, DX18G2, DX18G1, DX18QQ, DX9Black, DX9, DX10t, DX8G2, DX7G2, DX6G3, DX6e, NX8 and DX6G2

MEMORY CARD FUNCTIONS

Update Spektrum AirWare™ Software

NOTICE: The orange LED Spektrum bars flash and a status bar appears on the screen when Spektrum AirWare software updates are installing. Never power off the transmitter when updates are installing. Doing so may damage the system files.

NOTICE: Before installing any Spektrum AirWare files, always Export All Models to an Memory card separate from the Memory card containing the update. The update may erase all model files.

For more information on Spektrum AirWare software updates, visit www.spektrumrc.com.

Software updates may be completed with either the micro Memory card or using WiFi. See the section in this manual covering WiFi for more information about updating with WiFi.

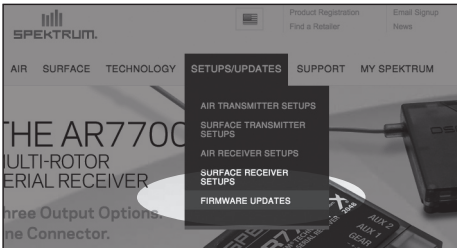

Automatically Installing Spektrum AirWare Software Updates

1. Go to www.spektrumrc.com. Under the Setups/Updates pull down tab, select the Firmware Updates link (shown).
2. Log into your Spektrum account.
3. Find your registered transmitter in the MY PRODUCTS list and click on Download Updates. Follow directions on the screen for downloading the update to an Memory card through your computer.

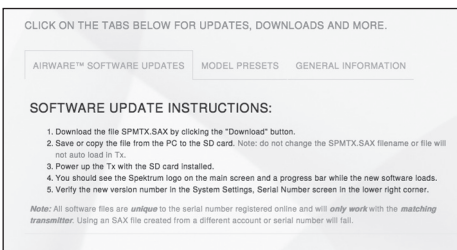
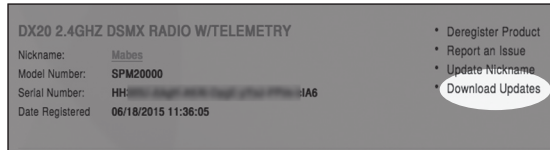

4. Eject the Memory card from the computer.
5. Make sure the transmitter is powered off and install the Memory card into the transmitter.
6. Power on the transmitter and the update automatically installs in the transmitter.

Manually Installing Spektrum AirWare Software Updates

1. Save the desired Spektrum AirWare version to an Memory card.
2. Install the Memory card into the transmitter.
3. Select Update Firmware in the Memory card Menu options. The Select File screen appears.
4. Select the desired Spektrum AirWare version from the File List. When updates are installing, the transmitter screen is dark. The orange LED Spektrum bars flash and the update status bar appears on the screen.

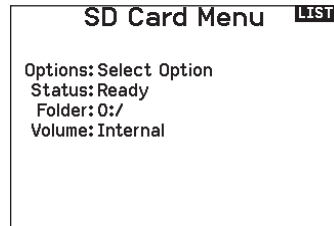

NOTICE: Do not power off the transmitter when updates are installing. Doing so will damage the transmitter.

Screen shots from www.spektrumrc.com are correct at time of printing but may change at a future date.

MODEL TYPE PROGRAMMING GUIDE

Menu options show up on model type selection. These menu options vary between Model Types (Airplane, Helicopter, Sailplane and Multirotor), but are identical for all models in that type. Subsequent aircraft type (Aircraft, Swashplate, Sailplane or Multirotor) selections make other menu options appear.



System Setup List:
Model Select
Model Type
Model Name
Aircraft Type
F-Mode Setup
Spoken Flight Mode
Channel Assign
Trim Setup
Model Utilities
Warnings
Telemetry
Preflight Setup
Frame Rate
Bind
Serial Port Setup
Trainer
Analog Switch Setup
Digital Switch Setup
Center Tone
Sound Utilities
System Settings
WiFi Utilities
USB Settings
Transfer SD Card
About/Regulatory

Function List:
Servo Setup
D/R and Expo
Differential
U-Tail Differential
Throttle Cut
Throttle Curve
3-Axis Gyro
Gyro (1,2,3)
Flap System
Mixing
Sequencer
Range Test
Timer
Telemetry
Forward Programming
Audio Events
VTX Setup
Function Bar
Start Timer
System Setup
Monitor



Model Select
Model Type
Model Name
Sailplane Type
F-Mode Setup
Spoken Flight Mode
Channel Assign
Trim Setup
Model Utilities
Warnings
Telemetry
Preflight Setup
Frame Rate
Bind
Serial Port Setup
Trainer
Analog Switch Setup
Digital Switch Setup
Center Tone
Sound Utilities
System Settings
WiFi Utilities
USB Settings
Transfer SD Card
About/Regulatory

Servo Setup
D/R and Expo
Differential
U-Tail Differential
Throttle Cut
Motor Curve
Camber Presets
Camber System
Mixing
Sequencer
Range Test
Timer
Telemetry
Forward Programming
Audio Events
VTX Setup
Function Bar
Start Timer
System Setup
Monitor



System Setup List:
Model Select
Model Type
Model Name
Swashplate Type
F-Mode Setup
Spoken Flight Mode
Channel Assign
Trim Setup
Model Utilities
Warnings
Telemetry
Preflight Setup
Frame Rate
Bind
Serial Port Setup
Trainer
Analog Switch Setup
Digital Switch Setup
Center Tone
Sound Utilities
System Settings
WiFi Utilities
USB Settings
Transfer SD Card
About/Regulatory

Function List:
Servo Setup
D/R and Expo
Throttle Cut
Throttle Curve
Pitch Curve
Swashplate
Gyro
Tail Curve
Mixing
Sequencer
Range Test
Timer
Telemetry
Forward Programming
Audio Events
VTX Setup
Function Bar
Start Timer
System Setup
Monitor



Model Select
Model Type
Model Name
Aircraft Type
F-Mode Setup
Spoken Flight Mode
Channel Assign
Trim Setup
Model Utilities
Warnings
Telemetry
Preflight Setup
Frame Rate
Bind
Serial Port Setup
Trainer
Analog Switch Setup
Digital Switch Setup
Center Tone
Sound Utilities
System Settings
WiFi Utilities
USB Settings
Transfer SD Card
About/Regulatory

Control Setup
D/R and Expo
Motor Cut
Motor Curve
Mixing
Sequencer
Range Test
Timer
Telemetry
Forward Programming
Audio Events
VTX Setup
Function Bar
Start Timer
System Setup
Monitor

SYSTEM SETUP

Enter the System Setup menu to define baseline settings for your model such as what type of aircraft, wing type, flight mode setup, etc. The options chosen in the system menu configures the function list for the chosen model number for your requirements. Some options, such as the flap menu, will not appear at all in the function list until they are selected within the System Setup menu.

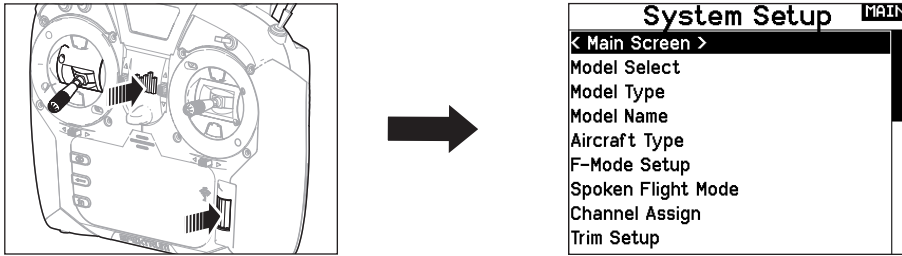

Press and hold the scroll wheel while powering on the transmitter to show the System Setup list. No radio transmission occurs when a System Setup screen is displayed, preventing accidental damage to linkages and servos during changes to programming.

You can also enter the System Setup from the Function list without turning the transmitter off. A caution screen will appear that warns that RF will be disabled (the transmitter will no longer transmit). Press YES if you are sure and want to access the System List. If you are not sure, press NO to exit to the main screen and continue operation.



WARNING: Do not press YES unless the model is turned off or the model is secured.

If you do not press YES or NO, the system will exit to the main screen and continue operation within approximately 10 seconds.

Model Select

Model Select enables you to access any of the 250 internal model memory locations in the Model Select list.

1. Scroll to the desired model memory in the Model Select list.
2. When the desired model memory is highlighted, press the scroll wheel once to select the model. The transmitter returns to the System Setup List.
3. Add a new model by rolling to the bottom of the list. You will then be prompted with the Create New Model screen, with the option to create a new model or cancel. If you select Cancel, the system will return to the Model Select function. If you select Create, the new model will be created and now be available in the model select list.

Direct Model Access

Press the Clear and Back buttons from the Main Screen or a telemetry screen to access Model Select.

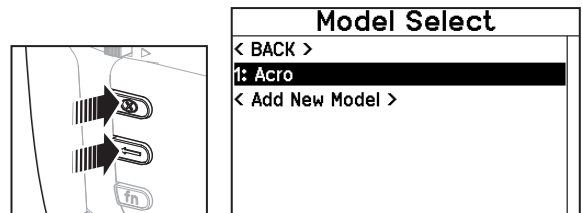

Model Type

Select from Airplane, Helicopter, Sailplane or Multicopter model types.

IMPORTANT: When you select a new model type, you will delete any programming data in the current model memory. Always confirm the desired model memory before changing model types. It will be necessary to re-bind after resetting the model type.

To change the model type:

1. Scroll to the desired model type and press the scroll wheel. The Confirm Model Type screen appears.
2. Select Yes and press the scroll wheel to confirm the model type. All data will be reset. Selecting No will exit the Confirm Model Type screen and return to the Model Type screen.

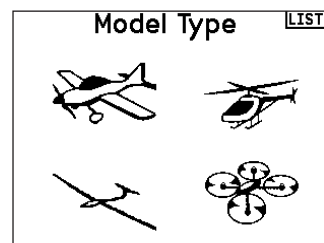

Model Name

Model Name enables you to assign a custom name to the current model memory. Model names can include up to 20 characters, including spaces.

To add letters to a Model Name:

1. Scroll to the desired letter position and press the scroll wheel once. A flashing box appears.
2. Scroll left or right until the desired character appears. Press the scroll wheel once to save the character.
3. Scroll to the next desired letter position. Repeat Steps 1 and 2 until the Model Name is complete. Insert a character by selecting <+> or delete a character by selecting <->.
4. Select BACK to return to the System Setup list.

To erase a character:

1. Press CLEAR while the character is selected.
2. Press CLEAR a second time to erase all characters to the right of the cursor.

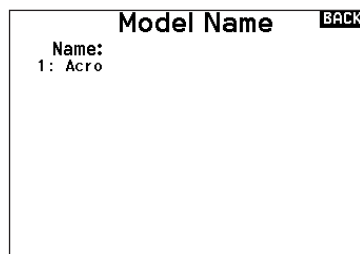

Aircraft Type

This menu is only available in Airplane Mode. See ACRO (Airplane) section for set up.

Sailplane Type

This menu is only available in Sailplane Mode. See SAIL (Sailplane) section for set up.

Swash Type

This menu is only available in Helicopter Mode. See HELI (Helicopter) section for set up.

Aircraft Options

This menu is only available in Multirotor Mode. See MULTI (Multirotor) section for set up.

F-Mode Setup

Use the Flight Mode Setup menu to assign switches to flight modes.

Flight Mode Setup

Mode	Number of Switches	Number of Flight Modes
ACRO	3	10
HELI	3 (including Throttle Hold)	5 (including Throttle Hold)
SAIL	3	10
MULTI	2	5

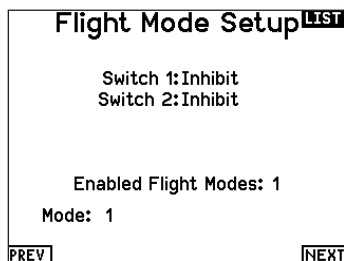

You can assign up to ten flight modes using any combination of up to three switches, maximum flight modes and switches available dependent on model type. You can also assign a priority switch. When the priority switch position is active, only the current flight mode is active, regardless of other switch positions.

Aircraft Flight Mode Table

You can assign the available flight modes to each of the switch positions (up to 3 switches can be used for Aircraft/Sailplane). Press NEXT from the Flight Mode Name page to access the flight mode table assignment page when Custom flight mode has been selected in the Flight Mode Setup page. The combination of switches can be used to access all of the flight modes available. Below is an example of 5 flight modes, you can configure up to 10 flight modes with the NX10:

Number of Flight Modes	2	3	3*	4	4	5
Switch 1 (number of positions)	2P	3P	2P	2P	3P	3P
Switch 2 (number of positions)			2P	3P	2P	3P
Flight Mode 1	Launch	Launch	Launch	Launch	Launch	Launch
2	Cruise	Cruise	Cruise	Cruise	Cruise	Cruise
3		Land			Land	Land
4			Thermal	Thermal	Thermal	Thermal
5				Speed		Speed

* Must be set up in a 4/5 flight mode.

Flight Mode Setup

Enables you to assign custom names to the Flight Mode positions. Flight Mode names can include up to 20 characters, including spaces.

To change the Flight Mode name:

1. Scroll to the Flight Mode name you wish to change and press the scroll wheel.
2. Scroll to the character position you wish to change and press the scroll wheel once. A flashing box appears.
3. Scroll left or right until the desired character appears. Press the scroll wheel once to save the character. Insert a character by selecting <+> or delete a character by selecting <->.
4. Repeat Steps 2 and 3 until the Model Name is complete.
5. Select BACK to return to the Flight Mode Names list.

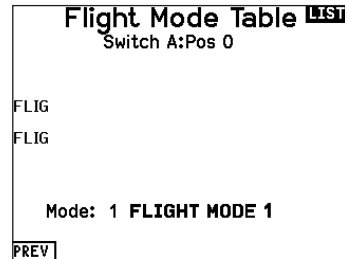

Channel Assignment

The Channel Assignment function allows you to reassign almost any receiver channel to a different transmitter channel. For example, the receiver gear channel could be re-assigned to the transmitter throttle channel.

1. Scroll to the receiver channel you wish to change.
2. Press the scroll wheel once and scroll left or right to change the receiver input selection.
3. Press the scroll wheel a second time to save the selection.

IMPORTANT: You cannot assign a mix to a channel that has been moved. Create the mix first, then move the channel.

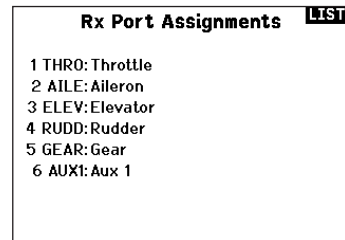

Channel Input Configuration

The Channel Input Configuration screen enables you to assign a transmitter channel to a different control stick or switch.

1. Select NEXT on the RX Port Assignments screen to access the Channel Input Configuration screen.
2. Scroll to the transmitter channel you wish to re-assign and press the scroll wheel. The box around the current input selection flashes.
3. Scroll left or right to select the desired control stick or switch.
4. Press the scroll wheel to save the selection.

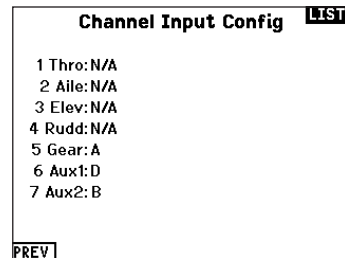

Trim Setup

Use the Trim Setup screen to change the size of the trim step and the trim type.

Trim Step

Adjusting the trim step value determines how many “clicks” of trim you input each time you press the trim button. Changing the trim step value to 0 disables the trim for the channel.

To change the trim step value:

1. Scroll to the trim step channel you wish to change.
2. Select the trim step value and scroll left or right to change the value.
3. Press the scroll wheel to save the selection.

Trim Type

The two Trim Type options are Common and F Mode.

Common trim type maintains the same trim values for all flight modes.

F Mode trim type enables you to save trim values for individual flight modes if you find, for example, the aircraft requires aileron trim in Flight Mode 1 but not in Flight Mode 2.

Trim Assignment

In a few instances, you can reassign a trim to a different location.

Aircraft Model Type

Throttle

- Throttle Digital trim button (default)

Left Lever

Right Lever

Throttle Trim Type

- Common
- Flight Mode

Trim Setup		LIST
		Trim Type
Spoiler:	5 Common	
Aileron:	5 Common	
Elevator:	5 F Mode	
Rudder:	5 Common	
Left Trimmer:	5 Common	Norm.
Right Trimmer:	5 Common	Norm.
Trims: Normal		

Trim Location

Normal and Cross trim types are available. Normal trims align with the control stick; for example, the throttle trim is next to the throttle stick.

Cross trims reverse the position of the trims; for example, the throttle trim is next to the elevator stick and vice versa.

To change the Trim Position from Normal to Crossed, select Normal at the bottom of the Trim Setup screen and press the scroll wheel.

IMPORTANT: Crossed trims will cross both sets of trims for both gimbals.

Model Utilities

In the Model Utilities function you can create a new model, delete a model, copy a model, reset a model to default settings and sort the model list.

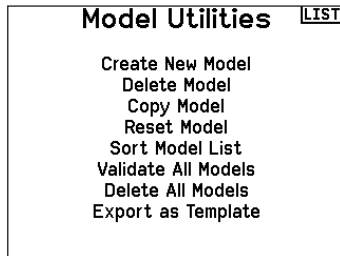

Create New Model

Use this selection to create a new model in the model select list.

1. Select Create New Model. Within this screen, you will have the option to create a new model or cancel.
2. Select the model type. Choose the aircraft image to define the model type for a blank model file, or select **Template** to load a template file. A SAFE template and a SAFE Select template come pre-loaded on your NX10.
 - Templates are saved in the templates folder on the internal memory (accessible with the USB connection, new .NSPM files may be added)
 - The SAFE template puts the 3 position flight mode switch (Channel 5) on switch B. The Panic button is on the I button (Channel 6). SAFE airplanes have a fixed configuration in the receiver and will match this setup after binding.
 - The SAFE Select template uses the D switch for flaps (Channel 5), the A switch for retracts (Channel 6), and the B button to turn SAFE select ON or OFF (Channel 7). Selecting this template alone will not enable SAFE Select, it must be done during the bind process. Also, the switch must be assigned in the receiver after binding, and the flap travel values need to be applied. See your airplane manual for more information.
3. If you select Cancel, the system will return to the Model Select function.
4. If you select Create, the new model will be created and now be available in the model select list.

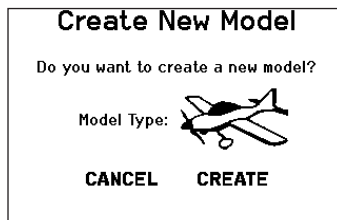

WARNING: Complete a preflight check before attempting to fly any model with a new model file or template. If you have the controls set up incorrectly for your aircraft, it may result in loss of control and a crash.

Select the BNF model type setting to access a list of pre-configured model files for Horizon Hobby BNF aircraft.

Delete Model

Use this selection to permanently delete a model from the model select list. If you do not wish to delete a model, select Cancel to exit the page.

1. To delete a model, highlight the model listed. Press to select, then roll to the model name. Press the scroll wheel to select.
2. Select DELETE to delete the model.

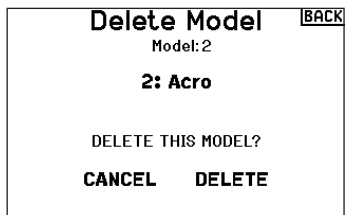

Copy Model

The Model Copy menu enables you to duplicate model programming from one Model List location to another.

Use Model Copy to:

- Save a default model copy before experimenting with programming values
- Expedite programming for a model using a similar programming setup

IMPORTANT: Copying a model program from one model memory to another will erase any programming in the “To” model memory.

To copy model programming:

1. Make sure the model program you wish to copy is active. If the desired model program is not active, select Cancel and change the active model in the Model Select menu.
2. Select the model memory next to “To” and scroll to the desired model memory. Press the scroll wheel once to save the selection.

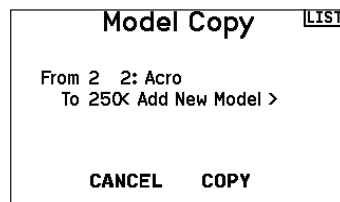

3. Select Copy and the Confirm Copy screen appears.
4. Select Copy to confirm. Selecting Cancel will return to the System Setup screen.
5. Select the “To” model as the current model, then bind the transmitter and receiver. Copying a model does not copy the bind from the original model.

You cannot use the Model Copy screen to copy model programming to a memory card. To copy model programming to a memory card, see “Transfer Memory Card”.

Model Reset

Use the Model Reset menu to delete all model programming in the active model memory. Reset returns all model settings to the default settings and erases all programming in the selected model. After a model reset, it is necessary to re-bind.

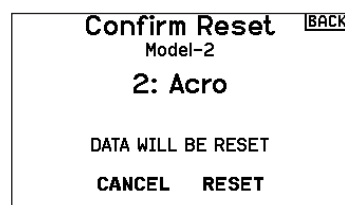

Sort Model List

With this function you can sort the model order in the model select function. This is helpful to group similar models together to make them easy to find. To move a model, highlight the model that you wish to move with the scroll wheel, then press the scroll wheel to select it. Scroll the scroll wheel to move the selected model to the position desired. Press the scroll wheel when you have the model in the position desired.

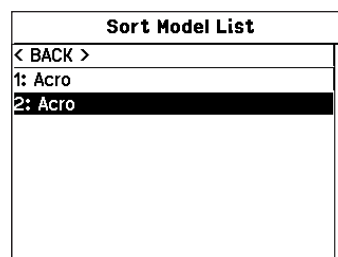

Validate All Models

Run this option to verify your model files are valid. If there are any corrupted model files this process can detect them.

Delete All Models

This option will delete all model files. Only run this option if you want to remove all models files, they cannot be recovered once this option has been executed.

Warnings

The Warnings menu enables you to program a voice, tone or vibration alert during power on of the transmitter for any selected switch or channel position.

The alarm activates and an alert message appears on the screen if a specific switch or control stick is in an unsafe position when you power the transmitter on.

Return the switch or control stick to the safe position to silence the alarm.

For safety reasons, the default throttle alarm activates if the throttle position is above 10%.

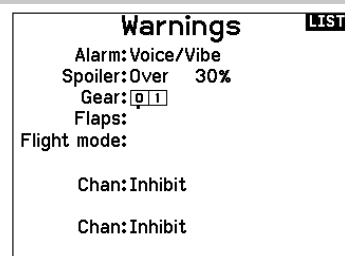

Telemetry

Installing the optional telemetry module and sensors enables the display of aircraft performance data on the transmitter screen.

You can also enable Data Logging to save a telemetry file on the Memory card and view the data in the Spektrum STI™ mobile application or other TLM file viewers.

Telemetry Settings

Display

Telemetry display options include:

Tele: When you press the scroll wheel, the Telemetry screens appear and the Main Screen is disabled.

Main: Telemetry alerts appear on the Main screen, but all Telemetry screens are disabled.

Roller (Default): Allows you to toggle between the Telemetry screens and the main screen by pressing the scroll wheel.

Auto: The Telemetry screen automatically appears as soon as the transmitter receives data from the telemetry module.

Units

Scroll to Units and press the scroll wheel to change between US and Metric.

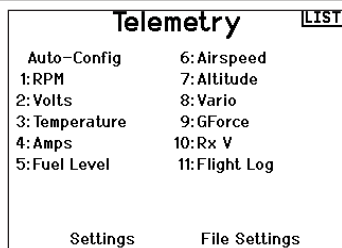

Telemetry Auto-Configuration

IMPORTANT: The Auto-Config option is not available from the System Setup>Telemetry menu. RF signal must be transmitting when you use the Auto-Config option. When the System Setup menu is active, RF signal is off.

The NX10 transmitter features telemetry Auto-Configuration, allowing the transmitter to detect new telemetry sensors.

To use Telemetry Auto-Config:

1. Make sure all telemetry components are bound to the transmitter and receiver.
2. Power on the transmitter, then power on the receiver.
3. Select Telemetry from the Function List, then select Auto Config. "Configuring" flashes for 5 seconds and any new sensors appear in the list.
4. Adjust the sensor alert values as necessary.

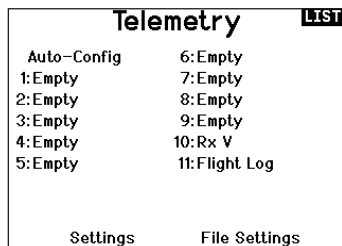

Status Reports:

Status Reports determines how often the transmitter refreshes the data on the screen. Each telemetry sensor can be adjusted independently. For example, the RPM status report can refresh every 10 seconds while the altimeter sensor refreshes every 15 seconds.

Warning Reports:

Warning Reports determines how often a telemetry alert occurs, if an alert is active.

Telemetry Alarms

Select Inh under Alarm to select the type of alarm desired.

Options include **Inh** and **Tone**.

File Settings

This is used to select the data logging settings.

File Name

1. Select File Name to assign a custom file name.
2. The File Name screen appears, allowing you to name the file as you would for a Model Name or Flight Mode Name. The file name can include a maximum of 8 characters.
3. Press BACK to save the name.

Start

1. Select Start to assign a specific switch position or stick position that activates Data Logging.
2. Press the scroll wheel once to save the selection.

Enabled

When Enabled is set to NO, Data Logging is turned off. Select YES to save Telemetry data to the Memory card. The Memory card must be installed in the transmitter to select YES.



CAUTION: If you access the Telemetry menu from the Function List, you may see a Frame Loss appear when you exit the menu. The Frame Loss is not an error, but there will be a momentary loss of radio signal when exiting the Telemetry screen. **DO NOT** access the Telemetry menu during flight.

Preflight Setup

The Preflight Setup menu option enables you to program a pre-flight checklist that appears each time you power on the transmitter or when you select a new model memory. Each item on the list must be confirmed before you can access the Main Screen.

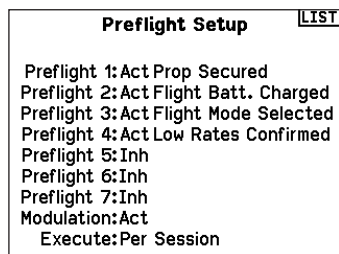

Frame Rate

The Frame Rate menu enables you to change the frame rate and modulation mode. Select the option you wish to change and press the scroll wheel.

You must use digital servos if you select 11ms frame rate. Analog and digital servos can be used with a 22ms frame rate.

Modulation Mode

We recommend using DSMX® (default) modulation mode. When DSMX is active, the transmitter operates in DSMX with DSMX receivers and DSM2 with DSM2® receivers. The transmitter automatically detects DSM2 or DSMX during binding and changes the mode accordingly to match the receiver type you are using.

If you select DSM2, the transmitter operates in DSM2 regardless of whether it is bound to a DSM2 or DSMX receiver.

*DSM2 is not available in the EU.

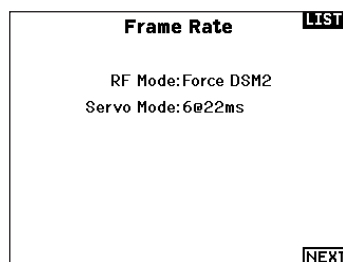

NOTICE: While DSMX allows you to use more than 40 transmitters simultaneously, do not use more than 40 transmitters simultaneously when using a DSM2 receiver or a transmitter in DSM2 mode.

NOTICE: For EU versions, DSM2 operation is not available.

Bind

The Bind menu enables you to bind a transmitter and receiver without powering off the transmitter. This menu is helpful if you are programming a model and need to bind the receiver for failsafe positions.

See "Programming Failsafe Positions" for more information.

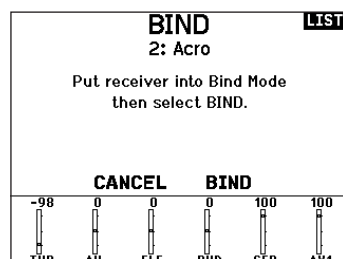

Serial Port Setup

Serial Output

The Serial Output menu manages serial port usage on the back of the transmitter. This port is designed to communicate with external RF devices using digital communication protocols. The NX10 includes the SRXL2 as well as the CRFS protocols for compatibility with the TBS Cross Fire and Cross Fire 2. In addition, the NX10 is engineered to deliver a 9.5V power supply for external devices. Any changes made in this menu will not be applied until the RF is re-enabled.

Serial Port Protocol

Scroll to the **Protocol**. Select **Inhibit**, **SRXL2**, **Cross Fire 1** or **Cross Fire 2**. Selecting the Cross Fire 1 or Cross Fire 2 options will enable the CRFS data stream. Connecting the Cross Fire system requires the Cross Fire serial port adaptor (SPMA3090, not included). Consult the manufacturer's manual for use of any external RF device. Horizon Hobby does not provide support for external RF devices connected to the NX10 transmitter.

Spektrum RF

Select Active to transmit Spektrum RF along with the data stream coming from the data port when other protocols are selected. The switch defaults to Active when the **Protocol** is set to **Inhibit**.

External Power (9.5v)

Select On when using an external power source for the external device. Select Off to use the internal power of the NX10 to power the device.

IMPORTANT: Battery use will be affected and the expected use time will decrease when using this option to power external devices.

Trainer

All options related to programming and using the trainer functions are controlled with the Trainer menu.

Three options are available in the trainer menu:

- **Wired Trainer**
- **Wireless Trainer**
- **Trainer Alerts**

Wired Trainer and Wireless Trainer have similar options when connecting two transmitters for the purpose of training a student pilot. In addition, an advanced menu for FPV pilots in both the Wired and Wireless Trainer menus provides specialized functions needed specifically for FPV head tracking applications.



Wired Trainer

Wired Trainer enables a student and instructor to work together by physically connecting two transmitters together with a cable. The optional Spektrum wired trainer adaptor (SPMA3091, not included) and trainer cable (SPM6805, not included) are required for wired trainer operation. The wired trainer adaptor connects to the serial port on the back of the transmitter. The trainer cable plugs into the adaptor.

Wired trainer supports up to 8 input channels with PPM based trainer systems connected. If the NX10 is used with a wired connection, the correct wired trainer option must be selected in the trainer menu and the student mode started or the wired trainer connection will not work.

When Wired Trainer mode is selected, a menu will appear. Select from the following trainer options:

Standard Instructor

This training mode designates the NX10 as the instructor, and requires the student transmitter to be fully configured, including reversing, travel, mixes, etc. This mode is helpful when the student has the full model configuration complete.

Wireless Trainer

Wireless Trainer enables instructors and students to work together without any cables connecting the transmitters. Wireless Trainer supports up to 10 channels of input depending on the number of channels available from the student transmitter or wireless headtracker. It is only necessary to put the instructor transmitter into the special wireless trainer bind mode. The student transmitter uses the normal binding process. Wireless Trainer modes are compatible with any Spektrum DSMX or DSM2 transmitter, Spektrum Focal® Headsets, and the small MLP4 and MLP6 transmitters from Horizon Hobby RTF models which include Spektrum technology.

Pilot Link Instructor

This training mode designates the NX10 as the instructor, and requires the student transmitter to have no settings applied, all of the reverse settings to normal and all travel settings at 100%. This option is intended to make it as simple as possible to connect any student transmitter to any airplane.

FPV

This mode is available for connecting a head tracking system to the NX10 for FPV use. See the Headtracking FPV Setup section for more information.

P-Link Student

This training mode designates the NX10 as the student transmitter. Use this option if the instructor transmitter is set up with Wired Pilot Link Instructor. A Start Student Mode button appears, which activates and deactivates wired trainer student capabilities. In this mode, the NX10 should be left on a default ACRO model with no changes.

Normal Student

This training mode designates the NX10 as the student transmitter. Use this option if the instructor transmitter is set up with Wired Programmable Instructor. A Start Student Mode button appears, which activates and deactivates wired trainer student capabilities. In this selection the NX10 must be fully configured to operate the aircraft.

When wireless trainer mode is selected, a drop down menu will appear with the following options:

Programmable Instructor

This training mode designates the NX10 as the instructor and requires the student transmitter to be fully configured, including reversing, travel, mixes, etc. This mode is helpful when the student has the full model configuration complete.

Pilot Link Instructor

This training mode designates the NX10 as the instructor and requires the student transmitter to have no settings applied, all of the reverse settings to normal and all travel settings at 100%. This option is intended to make it as simple as possible to connect any student transmitter to any airplane.

FPV

This mode is available for connecting a head tracking system to the NX10 for FPV use. This option is covered further in the Headtracking FPV Setup section.

Instructor Transmitter Configuration

1. Select the type of trainer mode for the application (Wired or Wireless, Programmable Instructor or Pilot Link Instructor).
2. Choose whether or not to enable Instructor Over-Ride. This setting defines how the instructor can resume control from the student. When enabled, the instructor must not move the sticks when the student is given control. Moving the sticks or moving the selected trainer switch will return control to the instructor.

With Instructor Over-Ride disabled, the switch position determines who is in control.

3. If Wireless Trainer mode was selected in step 1, Bind the student transmitter to the instructor transmitter. See the Binding Wireless Trainer section.
4. Determine which channels to assign to the student when given control by moving the on-screen switch for each channel. Students can be given control of a single channel or all channels, as the instructor sees fit.

Binding Wireless Trainer

Binding the NX10 wireless trainer feature as an instructor transmitter is not the same as binding the NX10 to an aircraft. The NX10 has a built-in receiver dedicated to the wireless trainer. The wireless trainer menu screens include a Bind button within the menu.

1. Touch the Bind button in the Wireless Trainer screen to enter trainer bind mode.

2. Long press on BIND.
3. Place the student transmitter in normal bind mode.
4. When the transmitters have completed the binding process, check the settings by opening the monitor screen on the instructor transmitter, giving control to the student transmitter and checking the monitor for correct control outputs.

Head Tracking FPV Setup

Wired FPV Mode: Enables the use of a headset with head tracking or another transmitter to control an onboard camera gimbal by physically connecting to the NX10 with a cable. The optional Spektrum wired trainer adaptor (SPMA3091, not included) and a trainer cable (SPM6805, not included) are required for wired FPV operation. The wired trainer adaptor connects to the serial port on the back of the transmitter. The trainer cable plugs into the adaptor. The wired trainer is compatible with PPM based trainer links.

Wireless FPV Mode: Enables the use of a Spektrum Focal headset with head tracking or another DSMX or DSM2 transmitter to control an airborne camera gimbal without connecting the NX10 to a cable. Wireless FPV modes are compatible with any Spektrum DSMX or DSM2 transmitter and Spektrum Focal headsets.

Each individual output channel can be mapped to any input channel from the trainer signal, leaving all other controls on the instructor transmitter. Primary flight control channels default to instructor control. Leave all channels connected to flight controls set up as instructor when using a headtracker.

To configure headtracking FPV:

1. Select either Wired or Wireless Trainer from the Trainer menu.
2. Select the FPV trainer mode.
3. Select the switch to enable/disable the head tracker.
4. Select the first **Output Channel** to be controlled. For example, if the pan servo is plugged into channel 5, select channel 5 as the output. Each axis of the gimbal will go to a separate output channel.
5. Change the mode to **STUDENT**. This selection only applies to the selected output channel.
6. Select the **Input Channel** from the trainer that controls the selected output channel when trainer is activated.
7. Input channels can be reversed or scaled in this menu to configure the student controls for correct response on the output channels. Normal servo setup menus for the output channel will be ignored when the trainer signal is commanding a given channel.
8. Repeat steps 4–7 to configure all the required output channels; select the **Output Channel** first, change the mode to **Student**, select the **Input Channel** and scale and reverse the travel as necessary.
9. For wireless connections, touch the **Bind** button to put the NX10 into trainer bind mode before powering on the wireless head tracker (student transmitter). See the Binding Wireless Trainer section for more information.

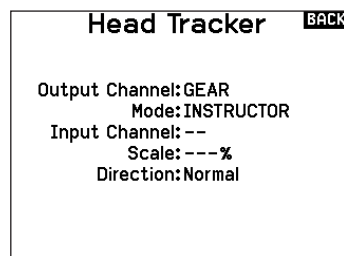
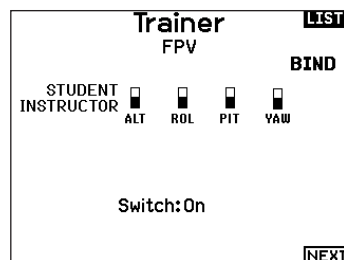

Center Tone

The Center Tone menu allows you to select or change the sound the NX10 makes when the selected control is at neutral.

1. Select a switch from the list.
2. Select the desired alarm. The choices are Inh, Tone, Vibe, Tone/Vibe, Voice, Voice/Vibe.
3. If either of the Voice alarms are chosen, select from the available spoken sound list.

Sound Utilities

Sound Utilities menu allows you to create, organize or remove your list of most commonly used voices, sounds and words into a category, allowing you to select those things most commonly used for sound events easily.

Choose Select/Add Category to enable Add Sound, Remove Sounds and Sort Sounds.

Palette Utilities

The colors on the NX10 may be customized as you wish. Select from the pre-defined color options listed under Global Customized, or select Personalize to create your own RGB color scheme.



System Settings

The System Settings menu consists of four screens:

- System Settings
- Extra Settings
- Serial Number
- Calibrate

Select NEXT or PREV to move between screens.

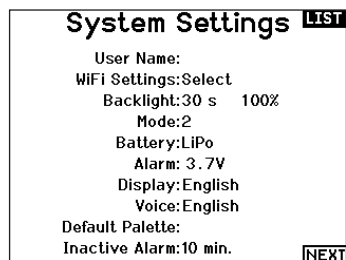

User Name

The User Name field displays your name in the lower right corner of the main screen.

To Program a User Name:

1. Scroll to User Name and press the scroll wheel. The User Name screen appears.
2. Scroll to the desired character position and press the scroll wheel. Scroll left or right to change the character and press the scroll wheel to save the selection. The User Name can contain a maximum of 20 characters, including spaces.
3. Press the Back button to save the User Name and return to the System Settings screen.

Brightness

The Brightness field adjusts the backlight appearance time and brightness. The brightness time options are:

On: The backlight is always on.

Set Time: The backlight is on for 3, 10, 20, 30, 45 or 60 seconds before automatically dimming. Press the scroll wheel once to turn the backlight on.

The backlight percentage adjusts the backlight intensity and it is adjustable in 10% increments from 10% (darker) to 100% (brighter).

Mode*

To change the gimbal stick mode:

1. Scroll to Mode and press the scroll wheel.
2. Scroll left or right to change the gimbal stick mode. Press the scroll wheel to save the selection.
3. Select NEXT in the lower left corner until the Calibration screen appears.

4. Move all transmitter controls to the center position and complete the calibration process before exiting the System Settings menu. See "Calibrating Your Transmitter" for more information.

* For more information, see Physical Transmitter Adjustments in the back of the manual.

Battery Alarm

The Battery Alarm is set to Lilon battery type for the NX10 and cannot be changed. The alarm activates when the battery reaches the low voltage limit.

To change the battery voltage trigger point for the alarm:

1. Scroll to the battery voltage and press the scroll wheel.
2. Turn the scroll wheel left or right to change the voltage level.
3. Press the scroll wheel again to save the selection.

Selecting a Language

In the Systems Settings screen, scroll to highlight language, then press the scroll wheel to select the language function. Scroll to select the desired Language. When the desired Language is selected, press the scroll wheel to accept that Language. Names you input will not be affected by language change. After changing the language for the text, you may also want to change the language for the spoken alerts.

Inactive Alarm

An alarm activates if the transmitter sees a period of inactivity for a certain amount of time. The alarm is helpful in reminding you to power off the transmitter and avoiding a situation where the transmitter battery completely discharges.

The Inactive Alarm options are:

- Inh (No alarm sounds)
- 5 min
- 10 min (Default)
- 30 min
- 60 min

To change the Inactive alarm time:

1. Scroll to the current alarm time and press the scroll wheel.
2. Scroll left or right to change the alarm time. Press the scroll wheel to save the selection.

Extra Settings

The Extra Settings screen enables you to:

- Turn sounds off or on
- Change the appearance of the trim indicators

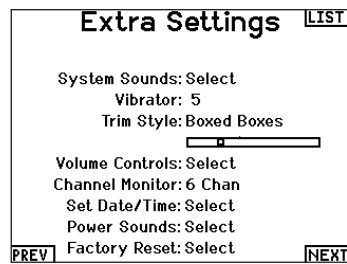

System Sounds

Scrolling to System Sounds and pressing the scroll wheel turns sounds on (Active) or off (Inhibit).

You may disable all sounds by changing the volume to 0.

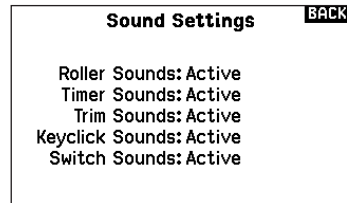

Vibrator Intensity Adjustment

Adjust this value to change the intensity of the built-in vibrator.

Trim Style

Trim style changes the shape of the trim indicators on the Main Screen. Display options include:

- Boxed Boxes (Default)— The indicators appear as an outlined box when you adjust the trim.
- Boxed Arrows— The indicators appear as outlined arrows when you adjust the trim.
- Arrows on Lines— The indicators appear as arrows on lines when you adjust the trim.

Inhibit removes all trim bars and indicators from the Main Screen.

To change the Trim style:

1. Scroll to Trim style and press the scroll wheel once.
2. Scroll left or right to change the Trim style option.
3. Press the scroll wheel to save the selection.

Volume Controls

When you select this option another screen is opened and each sub-system has a volume setting that can be adjusted from 0–100.

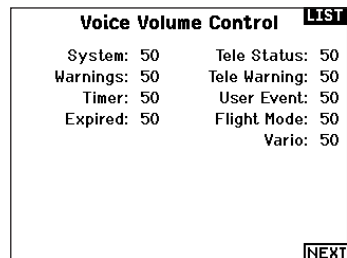

Channel Monitor

Select how many channels you want to display on the channel monitor (select from Default, 4, 6, 7, 8, 9, or 10 channels)

Set Date/Time

When you select this option another screen is opened. Set the time and choose the options to suit your needs.

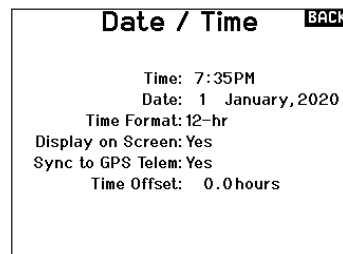

Power Sounds

Select from a variety of sound options the system will play at power up and power down.

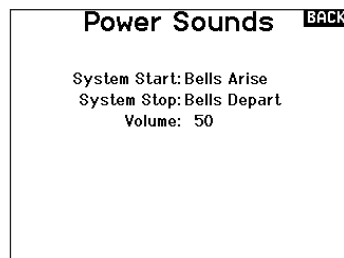

Factory Reset

Select this option to reset the NX10 back to factory settings. Choosing this option will wipe out any settings and all models that have been set in the NX10 programming.



Calibrate

The Calibration screen stores the potentiometer endpoints for all proportional controls. It is mandatory to complete the calibration after changing the stick mode selection.

To Calibrate the Transmitter:

- Carefully move the gimbal sticks in a + shape moving from left to right, then up and down. Press gently on the gimbals at the stops to achieve an accurate calibration. Return both gimbal sticks to the center position.
- Select SAVE to store the calibration.

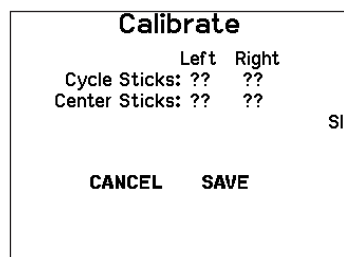

WiFi Utilities

First start an account at SpektrumRC.com first on your PC, Mac, or mobile device.

- Select WiFi Utilities. The NX10 will search for WiFi networks in range and display the options for you to connect with.
- Select your WiFi connection. Load the SSID and password for connection and select Connect.
- Select Log In and fill in your account information.
- Select Check For Updates to check for the newest updates on your NX10, and download them automatically.
- If you wish to erase your registration information from your NX10 you may do so. Otherwise, select Log Out to resume normal operation.

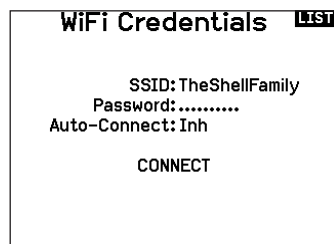

USB Settings

The USB Settings menu allows for setting the transmitter to Game Controller mode and for easy access to the internal memory storage. Setting the NX10 to Game Controller mode puts the system into USB HID mode, allowing for connection to compatible simulators directly as a game controller. The system uses the active model and disables the RF signal. Set the Mode to Inhibit to return to normal RF function.

Select Access Internal Storage to access the internal memory through the USB cable without transmitting an RF signal. Click the Back button or the roller to exit and enable the RF signal.

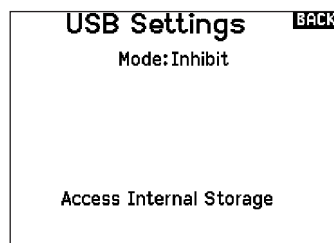

Transfer Memory Card

This menu enables you to:

- Import (copy) models from another NX10 transmitter
- Export (transfer) models to another NX10 transmitter
- Update Spektrum AirWare™ software in the transmitter
- Install/Update sound files
- Take screen shots
- Import or export color palettes
- Select from internal or external memory locations

Model Import/Export

Ensure the models currently stored in the internal transmitter memory are saved to a micro memory card separate from the transmitter before performing this function.

To import an individual model file from the Memory card:

1. Save the model file to the Memory card.
2. Select the Model List location where you wish to import the new model file.
3. In the Memory card menu, scroll to Select Option and press the scroll wheel once.
4. Scroll to Import Model and press the scroll button again to save the selection. The Select File screen appears.

IMPORTANT: When you select Import, the transmitter leaves the System Setup List.

5. Select the model file you wish to import. The Overwrite screen appears.
6. Select the model that you would like to import the model to.
7. Select Import to confirm overwriting the current model file. The transmitter activates the new model file and the Main Screen appears.

A Preflight Checklist may appear prior to the Main Screen if the checklist was active during the model file export. Select MAIN to exit the Preflight Checklist.

See “Preflight Setup” for more information.

Export Model

You can use the Export Model option to export a single model file to the memory card.

1. Make sure the active model file is the one you wish to Export.
2. In the Transfer memory card menu, scroll to Options and press the scroll wheel once.
3. Scroll to Export Model and press the scroll wheel again to save the selection. The Export to SD screen appears. The first two characters of the file name correspond to the Model List number (01, for example).
4. (Optional) If you wish to rename the model file before exporting it to the Memory card:
 - a. Scroll to “Save to:” and press the scroll wheel. The File Name screen appears.
 - b. Assign a new file name. The file name can contain up to 25 characters including the .SPM file extension.
 - c. When you are done assigning the new file name, press the Back button to return to the Export to SD screen.
5. Select Export to save the file to the memory card. When the export is complete, the transmitter returns to the memory card menu screen.

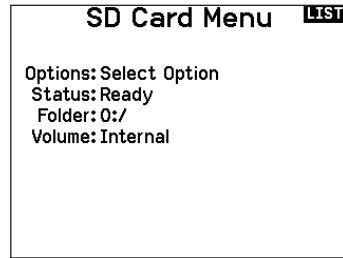

Import All Models

To import all models from the Memory card:

1. Select Import All Models.
2. Confirm by selecting IMPORT.

IMPORTANT: After importing a model, you must rebind the transmitter and receiver. The Main Screen must show DSM2 or DSMX in the upper left corner.

You can import a model to any location you want. If you prefer to use Import All, you can use your PC to rename the SPM file. The first two digits (01 to 50) are the destination model number. Your Memory card can only contain 50 models. Save files to folders on the card then remove from the card all unused models. Files are selected by their position in the directory table.

Memory Location

In the **Volume** selection you can choose from the **Internal** or **External** memory locations.

Select the internal memory location to save to the memory bank built into the NX10. Select the external memory location to save to the micro Memory card slot.

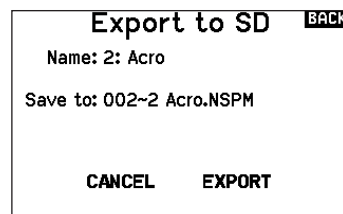

Export All Models

To export all models to the Memory card:

1. Select export all models in the Transfer Memory card menu options. The Export All Models screen appears.

IMPORTANT: Export All Models will overwrite any model files that:

- are already saved to the Memory card
 - have the same name. Always save model files to a different memory card if you are not sure.
2. Select Export to overwrite files on the memory card or Cancel to return to the memory card menu.

Importing/Exporting Color Palettes

Import Palette

You can use the Import Palette option to load a Palette from your memory card.

1. Load your color palette onto a memory card or the internal memory.
2. In the Transfer Memory Card menu, scroll to Options and press the scroll wheel once.
3. Select the memory card location (Internal or external) where your Palette has been loaded.
4. Scroll to Palette Import/Export and select Import Color Palette.
5. Select the Palette you want to load from your memory card.

Export Palette

You can use the Export Palette option to export a color configuration to the memory card.

1. Make sure the active palette is the one you wish to Export.
2. In the Transfer Memory Card menu, scroll to Options and press the scroll wheel once.
3. Scroll to Palette Import/Export and select Export Color Palette.
4. (Optional) If you wish to rename the Palette before exporting it to the memory card:
 - a. Scroll to "Options" and select Export Color Palette
 - b. Scroll to "Save to:" and press the scroll wheel. The File Name screen appears.
 - c. Assign a new file name. The file name can contain up to 25 characters including the .SPM file extension.
 - d. When you are done assigning the new file name, press the Back button to return to the Export to SD screen.
5. Use the Folder selection if you want to save to a sub-folder on the card
6. The Volume enables you to choose from the internal or external memory card locations.
7. Status informs you if the card is ready to use.
8. Select Export to save the file to the memory card. When the export is complete, the transmitter returns to the memory card menu screen.

Update AirWare

NOTICE: The orange LED Spektrum bars flash and a status bar appears on the screen when AirWare updates are installing. Never power off the transmitter when updates are installing. Doing so may damage the system files.

Before installing any AirWare files, always export all models to a memory card separate from the memory card containing the update. The update may erase all model files. For more information on AirWare updates, visit www.spektrumrc.com.

Installing AirWare Updates through WiFi

To install the most recent update:

1. Download the update from spektrumrc.com and save it to the Memory card.
2. The system allows you to install the update directly after downloading.

Automatically Installing Airware Updates With Memory Card

To install the most recent update:

1. Download the update from spektrumrc.com and save it to the memory card.
2. Power off the transmitter and install the memory card in the transmitter.
3. Power on the transmitter and the update automatically installs in the transmitter.

Manually Installing Airware Updates With Memory Card

1. Save the desired AirWare version to the memory card.
2. Select Update Firmware in the memory card menu options. The Select File screen appears.
3. Select the desired AirWare version from the file list. When updates are installing, the transmitter screen is dark. The orange LED Spektrum bars flash and the update status bar appears on the screen.

NOTICE: Do not power off the transmitter when updates are installing. Doing so will damage the transmitter.

About / Regulatory

Serial Number

The Serial Number screen displays the transmitter serial number and Spektrum AirWare software version. Reference the Serial Number screen any time you need to register your transmitter or update the Spektrum AirWare software from the Spektrum Community website.

Exporting the Serial Number to the Memory card

You may find it helpful to export the transmitter serial number to a text file for your personal records or when you are registering the transmitter on the Spektrum Community.

To export the transmitter serial number:

1. Insert an Memory card in the card slot on the transmitter.
2. Scroll to EXPORT and press the scroll wheel. The SD Status screen appears and should display MY_NX10.xml in the middle of the screen.
3. Press the scroll wheel again to return to the Serial Number screen.
4. Power off the transmitter and remove the Memory card from the transmitter.
5. Install the Memory card in a card reader connected to your computer.
6. Open the MY_NX10.xml file from the Memory card location. You can then copy and paste the serial number into your personal records or to the Spektrum Community website.

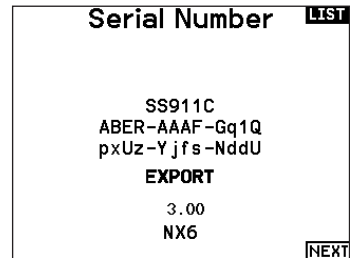

Locating the Transmitter Spektrum AirWare Software Version

The transmitter Spektrum AirWare software version appears between PREV and NEXT at the bottom of the Serial Number screen. Register your NX10 to get Spektrum AirWare software updates and other news at spektrumrc.com

IMPORTANT: Spektrum AirWare files are specific to the transmitter serial number and you cannot transfer Spektrum AirWare files between transmitters, ie., downloading an Spektrum AirWare software update once and attempting to install it on multiple transmitters.

FUNCTION LIST

Once you have selected the model number you want to use and have defined the aircraft type, wing and tail type and other details in the System Setup menu, use the Function list to define the details specific to your model's setup such as servo travel, reversing, mixing, etc. The Main Screen appears when you power on the transmitter. Press the scroll wheel once to display the Function List.

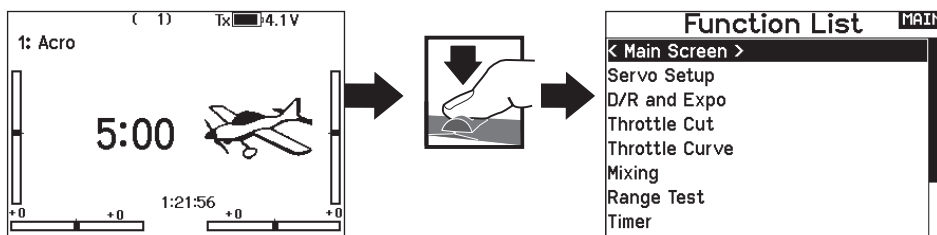

Servo Setup

The Servo Setup menu contains the following functions:

- Travel Adjust
- Sub-Trim
- Reverse
- Speed
- Absolute Travel
- Balance

Travel Adjust

Travel Adjust sets the overall travel or endpoints of the servo arm movement.

To adjust travel values:

1. Scroll to the channel you wish to adjust and press the scroll wheel. When adjusting travel values assigned to a control stick:
 - a. Center the control stick to adjust both directions at the same time.
 - b. To adjust travel in one direction only, move the control stick in the direction you wish to adjust. Continue holding the control stick in the desired direction while you are adjusting the travel value.
2. Scroll left or right to adjust the travel value. Press the scroll wheel to save the selection.

IMPORTANT: ALT, ROL, PIT and YAW replaces THR, AIL, ELE and RUD channels in multirotor to more closely reflect the flight axis in the multirotor aircraft. This change is throughout the multirotor menu options.

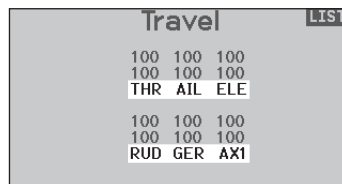
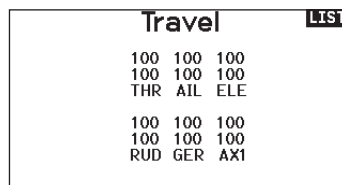

Sub-Trim

Sub-Trim adjusts the servo travel center point.

NOTICE: Use only small sub-trim values or you may cause damage to the servo.

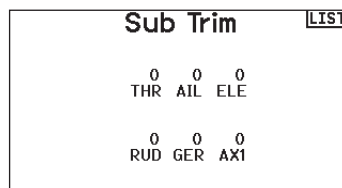

Reverse

Use the Reverse menu to reverse the channel direction. For example, if the elevator servo moves up and it should move down.

To reverse a channel direction:

1. Scroll to Travel and press the scroll wheel. Scroll left until Reverse appears and press the scroll wheel again to save the selection.
2. Scroll to the channel you wish to reverse and press the scroll wheel.

If you reverse the Throttle channel, a confirmation screen appears. Select YES to reverse the channel. A second screen appears, reminding you to bind your transmitter and receiver.

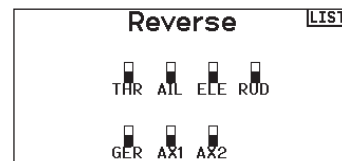

CAUTION: Always rebind the transmitter and receiver after reversing the Throttle channel. Failure to do so will result in the throttle moving to full throttle if failsafe activates.

Always perform a control test after making adjustments to confirm the model responds properly.

CAUTION: After adjusting servos, always rebind the transmitter and receiver to set the failsafe position.

Speed

The Speed menu enables you to slow the response time on any individual channel (such as retracts).

The Speed is adjustable in the following ranges:

- Nor (No Delay) – 0.9s in 0.1 second increments
- 1s – 2s in 0.2-second increments
- 2s – 8s in 1-second increments

To adjust the Speed:

1. Scroll to the channel you wish to adjust and press the scroll wheel.
2. Scroll left or right to adjust the speed and press the scroll wheel to save the selection.

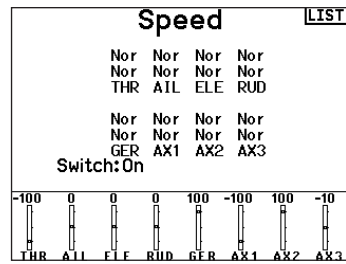

Absolute (Abs.) Travel

The Abs. Travel function limits the amount of travel on a channel. Adjust the Abs. Travel value to prevent a servo from binding when a mix is applied.

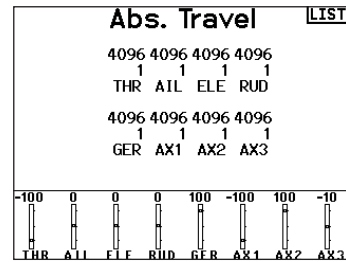

Balance

Balance is available on all channels to fine-tune the servo position at up to 7 points. This is a precision curve mix that is normally used to prevent binding when multiple servos are used on a single control surface.

You can also use the Balance menu option to match throttle response on twin engine aircraft or level the swashplate on a helicopter.

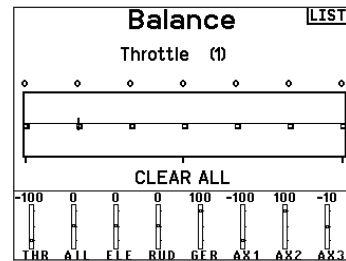

Dual Rates and Expo

Dual Rates and Exponential are available on the aileron, elevator and rudder channels.

To adjust the Dual Rate and Exponential:

1. Scroll to the channel and press the scroll wheel once. Scroll left or right to select the channel you wish to change and press the scroll wheel again to save the selection.
2. Scroll to Switch and select the switch to activate D/R and Expo for that channel.
3. Scroll to dual rate and press the scroll wheel. Scroll left or right to change the value and press the scroll wheel again to save the selection.

Exponential affects control response sensitivity around center but has no affect on overall travel. Positive exponential decreases the sensitivity around the center of gimbal movement.

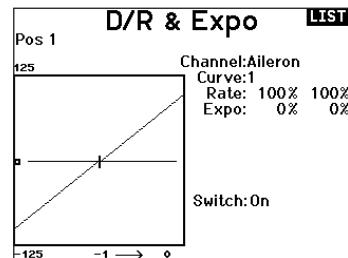

Differential (Acro and Sail Types Only)

The Differential screen enables you to increase or decrease the amount of differential between aileron control surface throws. Positive Differential values decrease the amount of “down” travel without affecting the “up” travel on the opposite control surface. Negative Differential values decrease the amount of “up” travel without affecting the amount of “down” travel on the opposite control surface.

The Differential menu option only appears when a multi-servo aileron wing type is active in Aircraft Type.

To adjust the Differential:

1. Scroll to Switch and press the scroll wheel. Scroll right to select On (Differential is always on) or assign the differential to a switch position.
2. Press the scroll wheel a second time to save the selection.

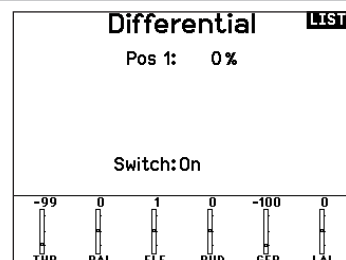

3. Scroll to the percentage selection and press the scroll wheel once to change the value.
4. Press the scroll wheel again to save the selection.

Throttle Cut (Acro and Heli Types Only)

The Throttle Cut menu option enables you to assign a switch position to stop an engine or motor. Throttle Cut activates regardless of Flight Mode.

When you activate Throttle Cut, the throttle channel moves to the pre-programmed position (normally Off).

You may need to use a negative value to move the Throttle channel to the off position.

CAUTION: Always test the model after making adjustments to make sure the model responds to controls as desired.

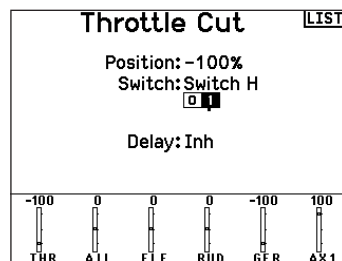

Throttle Curve (Acro and Heli Types Only)

You can use the Throttle Curve menu option to optimize the throttle response. A maximum of 7 points are available on the throttle curve.

To add points to a Throttle Curve:

1. Move the throttle stick to the position where you wish to add the new point.
2. Scroll to Add Pt. and press the scroll wheel to add the point.

To remove points from a Throttle Curve:

1. Move the Throttle stick until the cursor is near the point you wish to remove.
2. Scroll to Remove Pt. and press the scroll wheel once to remove the point.

If you program multiple throttle curves and you wish to edit one of the curves, that curve must be active in the Throttle Curve screen before you can make any changes.

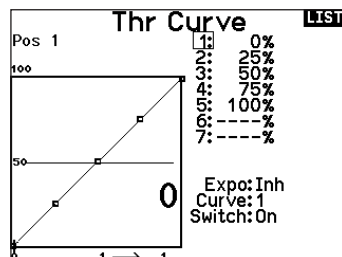

Analog Switch Setup

Allows all sticks and pots to be used as a kick point to turn on functions like mixes.

To add a kick point:

1. Move the control stick, lever or knob to the desired kick point position.
2. Scroll to the desired kick point and press the scroll wheel once to save the selection.

To delete a kick point, scroll to the desired kick point and press the Clear button.

Digital Switch Setup

Digital Switch Setup allows you to define the position values of each digital switch and flight mode switch. The switch can be assigned to a channel in the Channel Input Config function, and the output of the channel set in the Digital Input Setup screen. Additionally, the Flight Mode switch can have position values defined for each flight mode, and may be used as a mix input or channel input source, with the values defined in Digital Input Setup.

To use the Digital Switch Setup function:

1. Enter the Digital Input Setup screen, and press the roller with Inhibit selected.
2. Roll to select the switch or Flight Mode switch and press to select.
3. Roll to the desired position to adjust, and press the roller to select.
4. Roll to select the desired value, then press to select.
5. Repeat step 4 and 5 for all positions that you wish to adjust.
6. If you want to select a switch to control a channel, roll to select Channel: Inhibit on the bottom of the screen and press the roller. This will take you to the Channel Input Config screen to assign a channel to a switch.
7. Repeat 2 through 6 for all switches desired.

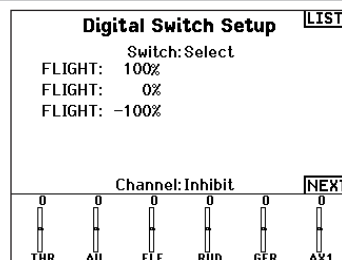

IMPORTANT: After you exit the Digital Input Setup screen, the return screen will show Inhibit at the top of the screen. If you wish to adjust a previously set value, select the switch and the previously set values can then be viewed and re-adjusted as desired.

Mixing

Mixing allows control input for a channel to affect more than one channel at a time. Mixing functions support:

- Mixing a channel to another channel.
- Mixing a channel to itself.
- Assigning offset to a channel.
- Linking primary to secondary trim.

These mixes are available for each model memory:

- 14 programmable mixes
- Rudder to Aileron/Elevator (ACRO)
- Cyclic to Throttle (HELI)
- Aileron>Rudder (SAIL)
- Swashplate (HELI)
- Aileron>Flap (SAIL)
- Elevator to Flap (ACRO)
- Elevator>Flap (SAIL)
- Aileron to Rudder (ACRO)
- Flap>Elevator (SAIL)

When you choose a new programmable mix you can select from either a normal mix or a curve mix. Specialized mixes will populate the mixing menu, and change based on aircraft type and wing type selections. Each specialized mix has specific features for its intended function.

Normal Mix

On the second line select a channel for master control on the left and slave on the right. Inputs for the master channel control both the master and slave channels. For example, Throttle > Rudder makes Throttle the master channel and Rudder the slave channel. A channel monitor at the bottom of the screen shows how channels respond to input during setup. To view a mix on the monitor, the mix switch must be in the active position or the switch set to ON.

Rate

Change the rate value to control the travel and direction (positive or negative value to reverse) of the slave channel.

Offset

Change the Offset value to move the effective center position of the slave channel. Positive or negative value determines the direction of the offset. Offset is not available for curve mixes.

Trim

If the master channel trim should also adjust the slave channel, set Trim to Act.

Curve (Page)

The Curve value corresponds to each page of values assigned to a switch position. Leave the Curve value matching the highlighted box below the switch position for a basic configuration.

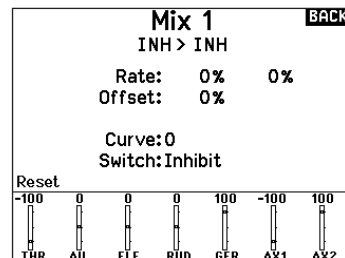
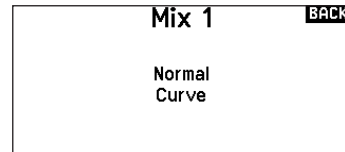
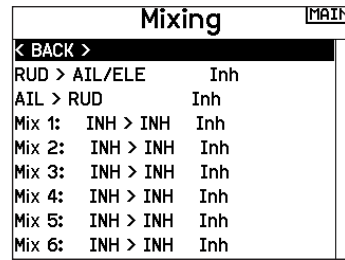

Switch

Select the switch you wish to use to activate the mix. The black box indicates the switch position where the currently displayed curve page is active, and the tick below the boxes indicates the current switch position.

Select ON if you wish to activate the mix full time and do not want to use a switch.

TIP: Use Auto Switch Select to select the switch.



CAUTION: Always do a Control Test of your model after changing mixes.

Curve Mix

If you want to be able to assign the output channel to respond on a curve or act as a switch, the Curve mix option will enable you to move the output channel to any value at up to 7 points along the travel of the input channel. Below the curve values, select a channel for master control on the left and slave on the right. For example, Throttle > Rudder makes Throttle the master channel and Rudder the slave channel.

A channel monitor at the bottom of the screen shows how channels respond to input during setup. To view a mix on the monitor, the mix switch must be in the active position or the switch set to ON.

Trim

If the master channel trim should also adjust the slave channel, set Trim to Act.

Curve

The Curve value corresponds to each page of values assigned to a switch position. Leave the Curve value matching the highlighted box below the switch position for a basic configuration.

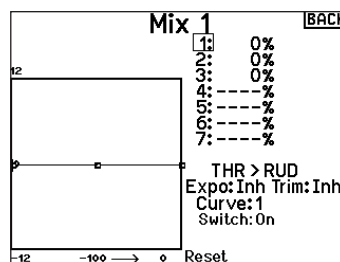

Switch

Select the switch you wish to use to activate the mix. The black box indicates the switch position where the currently displayed curve page is active, and the tick below the boxes indicates the current switch position.

Select ON if you wish to activate the mix full time and do not want to use a switch.

TIP: Use Auto Switch Select to select the switch.



CAUTION: Always do a Control Test of your model after changing mixes.

Curve (Page) Advanced Configuration Options

The Curve selection in either Normal or Curve mixes can enable you to set up to 9 different settings pages. Curve settings within one mix do not carry over to other mixes. This can be useful if you want to test mixes and not have delete current configurations, or can come into play when using numerous flight modes, with this option there can be a separate mix page for each flight mode.

To select the page you want to adjust:

1. Assign the switch and begin with your first switch position.
2. Scroll to the Curve option and change the value to the number you want for that Curve (page).
3. Scroll to the box above the active switch position and press the scroll wheel to assign the Curve (page) to that switch position.
4. Move the switch(es) to the next position you want to configure, select the Curve (page) you want to use, and repeat the process.

Sequencer

The Sequencer menu option provides this-then-that mixing with a time delay. Four sequences are available to control two functions each (A and B), in 2 timing directions (forward or reverse). Sequences appear throughout function screens as assignable switches.

Sequencer			LIST
#	Sw	Names	
1	Inh	Door Cycle / Wheels	
2	Inh	Door Basic / Wheels	
3	Inh	S3A / S3B	
4	Inh	S4A / S4B	



CAUTION: Always review the action of a sequence on the Monitor screen BEFORE operating the model to ensure controls act as desired. Failure to do so could cause a crash, resulting in property damage and/or injury.

You can program multiple functions to sequentially activate in response to an assigned switch. For example, an assigned Gear switch can open gear doors, lower the gear, then close the doors. In reverse, gear doors open, the gear retracts and the gear doors close. You can assign each Sequencer function to a switch in most Function screens such as Flight Mode, Dual Rate, Mixing, Throttle Curve, Pitch Curve, etc.

You can assign several functions to a sequence to decrease the number of controls you need to touch during complex flight transitions—for example, applying your assigned dual rates and exponential when the landing gear deploys and the flight mode changes.

If you select an S-Number-A sequence (e.g. S3A), the sequence operates as a timed 5-position switch. An S-Number-B sequence operates as a timed 3-position switch. The 5 positions correspond to the sequencer values shown on the time delay graph in the second Sequencer screen. In a function screen, highlight each point (0–4) and select the switch position desired for a function to be active.

When S1B (or another sequence-number-B) is selected as a switch in a function, the sequence will operate as a timed 3-position switch. The 3 positions act as 'kick points' of the movement at fixed percentages (equal thirds) of the sequencer output. In a function screen, highlight each point (0–2) and select the switch position desired for a function to be active.

Sequencer		LIST
Switch:	Switch A	Speed
Forward:	0 1	10
Reverse:	0 1	10
Name A:	Door Cycle	(DOR)
Name B:	Wheels	(WHL)
Chan A:	Inh	Type A: Step
Chan B:	Inh	Type B: Step

Sequencer Set Up

1. In the first Sequencer screen, select 1 of the 5 available sequences.
2. In the second Sequencer screen, assign a switch to the sequence. We recommend using a 2-position switch.

TIP: If you need to use a 3-position switch, you must assign one direction to two adjacent switch positions—e.g., 0 and 1. Assign the opposite direction to the third switch position.

3. Assign the timing for the Forward and Reverse directions as desired. There is no delay when you use the Nor option. You may also select a delay time between 0 and 30 seconds.
4. Assign names for each sequencer function as desired.
5. Select either **Step (S)** or **Proportional (P)** for the Sequencer output.

Step: The sequence only changes at kick points. Otherwise, there is a delay in the sequence until it reaches the next kick point.

Proportional: The sequence movement is proportional between kick points. The sequence maintains rate and direction until it reaches the next kick point.

6. Adjust the Sequencer motion percentages in the third screen.

For example, you may move points 1, 2 and 3 closer to the beginning of the sequence so the motion occurs earlier. This results in a delay between point 3 and point 4 at the end of the sequence.

Testing the Sequence

The Sequencer function determines the response for channels included in the sequence.

Refer to the Monitor screen to see how respective channels interact in the Sequencer.

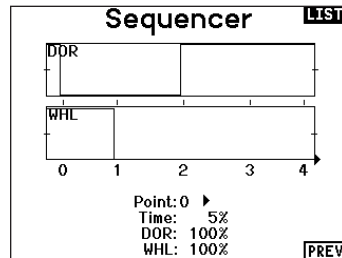

Range Test

The Range Test function reduces the power output. This allows for a range test to confirm the RF link is operating correctly. Perform a range check at the beginning of each flying session to confirm system operation.

To Access the Range Test screen:

1. With the transmitter on and the main or telemetry screen displayed, press the scroll wheel. The Function list displays.
2. Scroll to highlight Range Test, then press the scroll wheel to access the Range Test function.
3. With the Range Test screen displayed, push and hold the trainer button. The screen displays Reduced Power. In this mode the RF output is reduced allowing for an operational range test of your system.
4. If you let go of the trainer button, the transmitter will go back to Full Power.

IMPORTANT: Telemetry alarms are disabled during the Range Test.

Range Testing the NX10

1. With the model restrained on the ground, stand 30 paces (approx. 90 feet/28 meters) away from the model.
2. Face the model with the transmitter in your normal flying position and place the transmitter into Range Test mode (see above). Then push the trainer button; the power output will be reduced.
3. Operate the controls. You should have total control of your model with the transmitter in Range Test mode.
4. If control issues occur, contact the appropriate Horizon Product Support office for assistance.
5. If performing a range test while a telemetry module is active, the display will show flight log data.

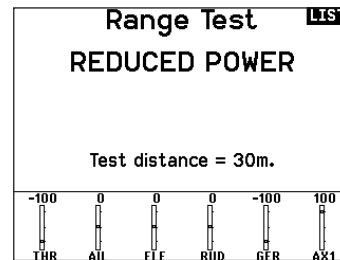

Timer

The NX10 Timer function allows you to program a countdown timer or stop watch (count up timer) to display on the main screen. An alarm sounds when the programmed time is reached. You can program the timer to start using the assigned switch position or automatically when throttle is raised above a programmed position. Two internal timers are available that show run time for a specific model displays on the Main Screen. A total system timer is also available.

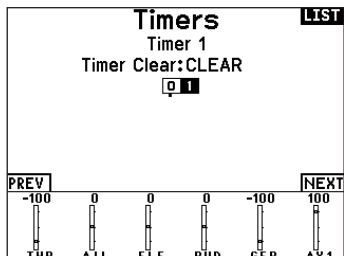

Press NEXT to select the Timer Event Alerts settings. These include options for the alerts at every minute for down timers, 1 minute remaining alert, 30 seconds remaining alert, 10 second to 1 second remaining alerts, expiration alert, and every minute up alert. Press NEXT again to select the Timer Control Alerts settings. Available options include Timer Start alert, Timer Stop alert, and Timer Reset alert.

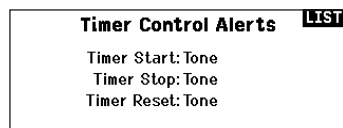
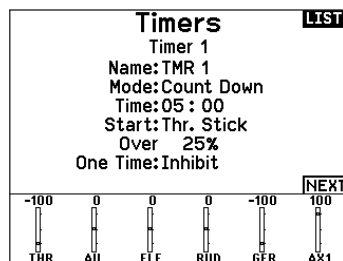

Telemetry

Telemetry is in both the system setup and the function list so you can access the telemetry functions from either list.

You must power off the receiver and transmitter, then power them both on to reset the telemetry data. You can reset min/max values by pressing the CLEAR button.

NEVER change Telemetry settings when the aircraft is powered on. There is a brief interruption in RF output when exiting the Telemetry screen, and may cause a "Hold" condition.

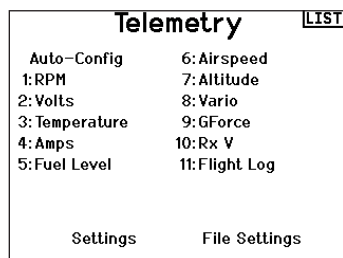

Forward Programming

If you Bind a Forward Programming capable receiver to your NX10, a Forward Programming menu will appear in the Function List automatically. Think of the Forward Programming menu as a programming interface for your connected receiver. The menu structure, options and any changes made are done directly on the receiver, the transmitter is only an interface. Each device may have different menu structure and operate in a different manner than the next Forward Programming device. The receiver must be powered on and connected to be able to enter the forward programming menu.



Audio Events

For compatible video transmitters, this menu can select the options directly from your NX10. Set the Power level and frequency of your video transmitter, and select Send to make the change.

Switch Changes

Use the switch change report to call out what your switch positions are. With this menu you can assign audio reports for events such as changing modes or rates, retract position, flap position, etc.

Stepping Reports

Stepping reports let you select from a list of reports to announce at each flip of a switch. Stepping reports move to the next report at every flip of the switch.

Generic Reports

Select Report At Power-Up and check off your desired switches to get a switch position report of those switches when you power ON the transmitter.

Center Tone

This menu gives you the ability to add a tone at the center of each stick travel.

Flight Modes

Choose your audio reports to go with each flight mode in this menu.

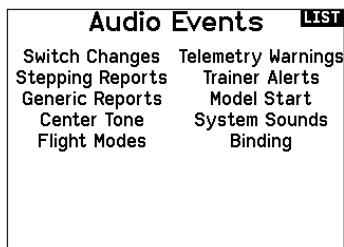

Telemetry Warnings

Shortcut to the Telemetry Warnings screen.

Trainer Alerts

This menu gives the user the setup the type of audio alerts with trainer.

Model Start

This menu gives you options for tones and voice for when your model starts operation, based on throttle or a switch of your choice.

System Sounds

Gives you control over the inactivity alarm and the low voltage alarm

Binding

Gives you control over the audio events during the bind process.

VTX Setup

For compatible video transmitters, this menu can select the options directly from your NX10. Set the power level and frequency of your video transmitter, and select SEND to make the change.

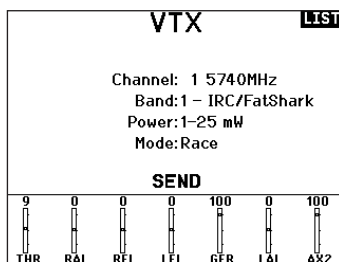

Function Bar

The Function Bar on the NX10 offers 2 features, a Ticker Tape to show telemetry values and My List which allows quick access to menu items chosen that are frequently used.

When the NX10 transmitter is showing the normal display (home screen), the system shows the telemetry scrolling across the bottom of the screen.

Select Function Bar on the Function List to access the setup screen. Select the Ticker Tape Setup or the My List Setup for configuration.

Ticker Tape Setup

The screen can display up to 10 features on the bar.

Each slot can be configured to hold:

- A telemetry sensor report
- The position of an input switch

Sensor Configuration

Pick the sensors you want to display from the list of sensors in the active telemetry list. After selecting a sensor, configure the data to display to suit your needs.

Field

Select the input you want to have displayed, and the amount of time it should be shown.

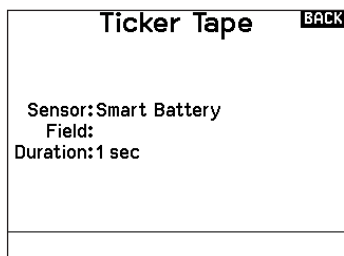

My List Setup

My List gives you quick access to a short list of commonly used menu items you create.

- Press the Function button to open My List
- Scroll to select the menu you want, and click to choose that option
- CLEAR will take you to the first entry on the list
- BACK or FUNC will exit to original screen

IMPORTANT: If a menu option is not available on the Function List such as due to a Wing/Tail type change, it will not be selectable from the My List.

IMPORTANT: You can pick entries from the Function List, however you cannot pick sub-options for the My List setup.

Bind

The Bind menu allows access to the bind screen from the Function List. After selecting Bind, a caution screen appears warning the transmitter RF will be disabled. Press YES to continue to the bind screen or NO to return to the Function List.

The Bind menu enables you to bind a transmitter and receiver without powering off the transmitter. This menu is helpful if you are programming a model and need to bind the receiver for failsafe positions.

See "Programming Failsafe Positions" for more information.

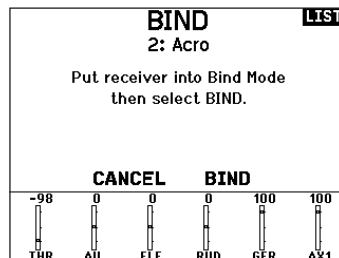

Start Trainer

The Start Trainer menu allows you to put the transmitter in either instructor or student mode, from the Function List.

System Setup

Use System Setup to enter the System List from the Function list without turning the transmitter off. A caution screen will appear that warns that RF will be disabled (the transmitter will no longer transmit). Press YES if you are sure and want to access the System List. If you are not sure, press NO to exit to the main screen and continue operation.

If you do not press YES or NO, the system will exit to the main screen and continue operation within approximately 10 seconds.

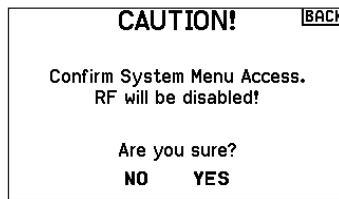

WARNING: Do not press YES unless the model is turned off or the model is secured.

Monitor

The Monitor screen displays the servo positions for each channel graphically and numerically. This is useful to verify programming functions, trim settings, mix directions, etc. The numeric value is directly relative to the travel adjust and mix values (e.g. 100% travel adjust equals 100% value in the Monitor).

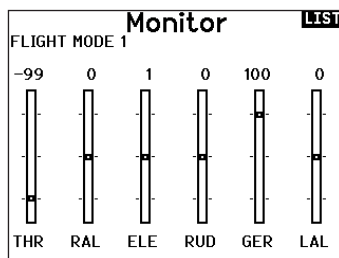

The following menu options are only available when they are enabled from the Model Type screen.

V-Tail Differential

Only available in Sailplane Type when V-Tail A or V-Tail B is active. See SAIL (Sailplane) section for set up.

Camber Preset

Only available in Sailplane Type when a 2+ aileron wing type is selected. See SAIL (Sailplane) section for set up.

Camber System

Only available in Sailplane Type when a 2+ aileron wing type is selected. See SAIL (Sailplane) section for set up.

Flap System

Only available in Airplane Type when a flap-enabled wing type is selected. See ACRO (Airplane) section for set up.

Pitch Curve

Only available in Helicopter Type. See HELI (Helicopter) section for set up.

Swashplate

Only available in Helicopter Type. See HELI (Helicopter) section for set up.

Gyro

Only available in Helicopter Type. See HELI (Helicopter) section for set up.

Tail Curve

Only available in Helicopter Type. See HELI (Helicopter) section for set up.

Motor Cut

Only available in Multicopter Type. See MULTI (Multicopter) section for set up.

Motor Curve

Only available in Multicopter Type. See MULTI (Multicopter) section for set up.

ACRO (AIRPLANE)



CAUTION: Always do a Control Test of your model with the transmitter after programming to make sure your model responds as desired.

NOTICE: Refer to your airplane manual for recommended control throws.

Aircraft Type

Use the Aircraft Type Screen to select wing and tail types to match your airplane model. Diagrams and setup names show on the transmitter screen to show the available setups.

Select wing and tail types before doing any other programming.

Refer to spektrumrc.com for more information about new NX10 AirWare software updates to support these options.

Wing

- Normal
- Flaperon*
- Dual Aileron*
- 1 Aileron 1 Flap*
- 1 Aileron 2 Flap*
- 2 Ailerons 1 Flap*
- 2 Ailerons 2 Flap*
- Elevon A*
- Elevon B*
- 4 Aileron

Tail

- Normal
- V-Tail A**
- V-Tail B**
- Dual Elevator
- Dual Rudder
- Dual Rudder/Elevator
- Taileron
- Taileron B
- Taileron + 2 Rudders
- Taileron B + 2 Rudders

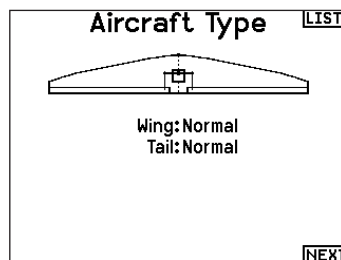

*Selection of multiple ailerons activates the Differential menu option.
 **“V-Tail A” and “V-Tail B” function as internal servo reversing. If V-Tail A does not work correctly with your aircraft, try V-Tail B.

Recommended Servo Connections

Dual Aileron Wing Type Connection



Elevon Wing Type Connection

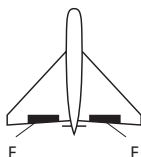

V-Tail Type Connection

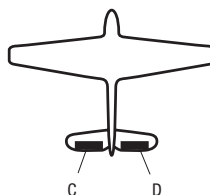

- A** AUX1 servo port (left aileron)
- B** AILE servo port (right aileron)
- C** ELEV servo port (left V-tail)
- D** RUDD servo port (right V-tail)
- E** AILE servo port (left aileron)
- F** ELEV servo port (right aileron)

Aircraft Options

To change the Aircraft Icon:

1. In the Aircraft Type Screen, select NEXT at the bottom right of the screen. This will access the Aircraft Options screen.
2. Scroll to the image and click once. Roll the scroll wheel left or right for optional images.
3. Click on the image you wish to select.

To use the gyro menus:

Chose **3-Axis Gyro** if you want to use a single gain value to manage your 3-axis gyro. If you want change gyro gain to match your flight modes, select **Gyro 1, 2** or **3**.

To use the Pitch Curve:

If you want a pitch curve on an airplane, activate this function.

You can only use two of these options due to the channel count limit of your NX10. Once these options are chosen, the related menus appear in the Function List.

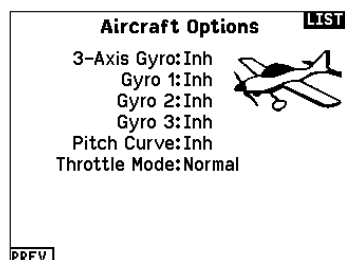

Elevon Servo Control

The possible servo reversing options for a delta wing model are:

Aileron	Elevator
Normal	Reverse
Normal	Normal
Reverse	Reverse
Reverse	Normal

TIP: If you test all servo reversing options and the control surfaces do not move in the correct direction, change the Elevon wing type in the System Setup list from Elevon A to Elevon B.

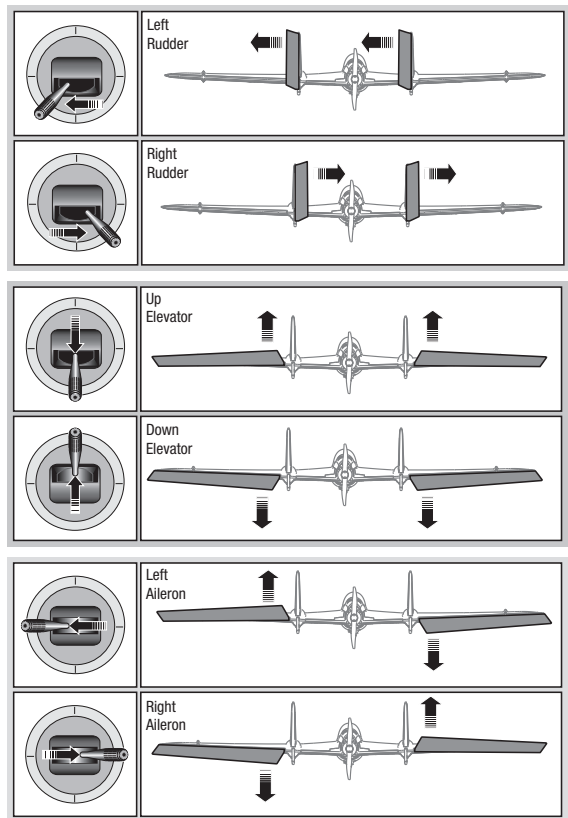

Flap System

The Flap System menu option enables flap programming as well as elevator mixing. You must select a flap-enabled wing type in Aircraft Type or the Flap System menu does not appear.

To activate the Flap System:

1. Access the System Setup list and select Aircraft Type.
2. Select a flap-enabled wing type and exit the System Setup list.
3. Access the Function List from the Main Screen and select Flap System.
4. Select Inhibit and scroll to the switch or lever you wish to use to control the flap channel.

5. Assign the Flap travel values and any desired Elevator mixing.
6. Select a Flap speed, if desired. Norm (default) does not have a delay. Flap speed options range from 0.1s to 30 seconds.

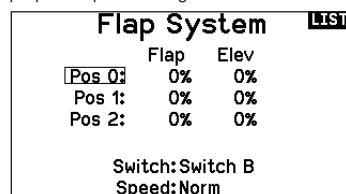

ACRO Mixing

Rudder to Aileron/Elevator

Rudder to Aileron/Elevator mixing corrects coupling in knife edge flight.

- Add Elevator mixing if the aircraft pitches toward the landing gear or canopy
- Add Aileron mixing if the aircraft rolls in knife edge flight

Aileron to Rudder

Use Aileron to Rudder mixing to overcome adverse yaw characteristics with certain types of aircraft (such as high-wing aircraft).

Elevator to Flap

Elevator to Flap mixing enables Flap movement when the Elevator stick moves. Use Elevator to Flap mixing to add the spoileron function to 3D aerobatic aircraft. This mix is available when a flap or dual aileron wing type is selected.

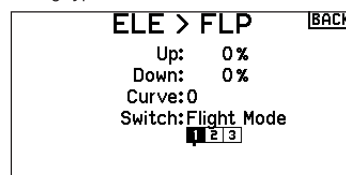

Differential

If you enable a wing type with two aileron servos, the function menu will have a Differential menu added. This feature is intended for you to be able to set the ailerons for equal travel, or to be able to set them for more up travel than down travel, depending on your aircraft and intentions.

To use the Differential System:

1. Select the switch you want to use. If you want to use one setting full-time, set the Switch to ON.
2. Set your values to achieve your desired results. Positive and negative values will have an opposite effect.

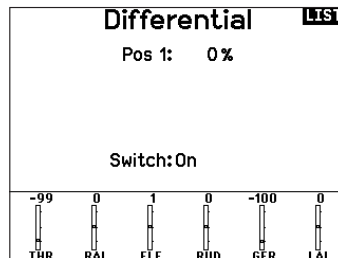

V-Tail Differential

If you enable a V-Tail tail type, the function menu will have a V-Tail Differential menu added. This feature is intended for you to be able to set the control surfaces for equal travel, or to be able to set them for more up travel than down travel, depending on your aircraft and intentions.

To use the V-Tail Differential System:

1. Select the switch you want to use. If you want to use one setting full-time, set the Switch to ON.
2. Set your values to achieve your desired results. Positive and negative values will have an opposite effect.

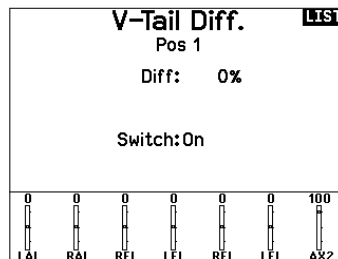

Gyro Menus

Gyro menus can be used to control a gain value. Enable the menu you wish to use in the Aircraft Type -> Aircraft Options selection in the System Menu.

3-Axis Gyro

Select the Channel and switch you want to use and fill in your gain values in the switch positions.

Gyro (1,2,3)

This menu selection can give you more finite control over gain values along specific points of input. Select your input channel and your gain channel, and fill in the values you want to use. move the input channel and press Ad Pt. to add a point along the curve. select a different Curve (page) to store multiple sets of values for testing.

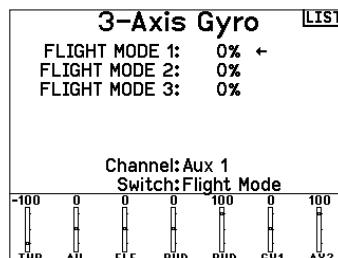

HELI (HELICOPTER)

CAUTION: Always do a Control Test of your model with the transmitter after programming changes to make sure your model responds as desired.

NOTICE: Refer to your helicopter, gyro and governor manuals for programming recommendations.

To change the Helicopter Icon:

From the Collective Type Screen, select NEXT at the bottom right of the screen. This will access the Heli image screen. Scroll to the icon and click once. Roll the scroll wheel left or right for optional icons.



Swash Type

The Swash Type menu option assigns the swash type for your particular helicopter model.

Select the Swash Type before completing any programming in the Function List. The Swash Type will affect menu options in the Function List.

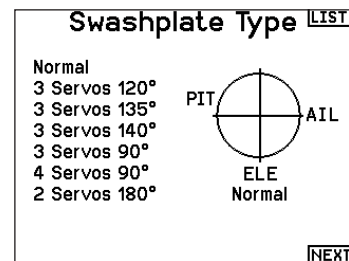

Collective Type

The collective type is used to turn on "Pull" collective for reversed collective. Available settings are Normal and Reverse. Press NEXT from the Swashplate Type screen to access the Collective Type screen. The Collective Type allows the throttle/pitch stick to operate in reverse and ensures trims, curves and all other functions that are to work in reverse function properly.

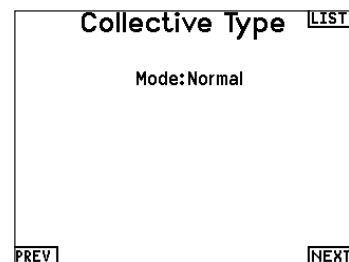

Pitch Curve

This function supports adjustment of collective pitch in 5 flight modes.

To adjust the Pitch Curve:

1. Select the Pitch Curve you wish to edit (N, 1 or 2).
2. Scroll right to select the points on the curve and edit the respective values.
3. Press the **BACK** button to save the Pitch Curves and return to the Function List.

Swashplate

The Swashplate menu option enables you to adjust the following:

- Swashplate Mix
- Exponential
- E-Ring
- Elevator Compensation

Use positive or negative Swashplate mix values as needed for correct direction response of the helicopter.

Before making adjustments to the Swashplate mix, make sure the throttle/collective pitch input moves the entire swashplate up or down. If the servos are not moving in the same direction, reverse them as necessary in the Servo Setup menu option.

When the entire swashplate moves up or down:

1. Adjust the mix value for the Aileron and Elevator channels. If the servos do not move in the correct direction, change the direction of the mix—for example, a positive value instead of a negative value.
2. Adjust the mix value for the Pitch. If the swashplate does not move in the correct direction, change the direction of the value (negative instead of positive).

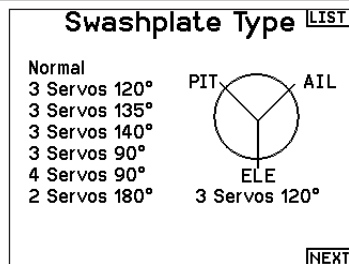

Always enable Expo when using a standard rotating-arm servo. The Expo delivers linear movement of the swashplate from a standard rotary servo. When Expo is inhibited, the arm on a rotary servo moves on a curved path with decreased swashplate movement at the extremes of the servo arm travel.

NOTICE: Do not enable Expo when using a linear servo.

Electronic E-Ring

This feature prevents over driving servos by limiting servo travel if the sum of your cyclic and pitch inputs exceeds servo limits.

Gyro

The Gyro menu option enables you to assign a gyro gain value to an independent switch or a Flight Mode. Assign the receiver channel connected to the gyro, then assign the switch for gyro options. You can also assign values to available switch positions (from 1 to 4 rates are available, depending on the switch assigned). Make sure the gyro operates correctly and compensates in the correct direction.

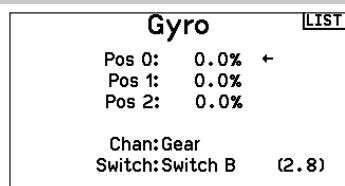

Tail Curve

The Tail Curve function mixes tail rotor input with the throttle/collective function to counter torque from the main rotor blades when using a non-heading hold (tail lock) gyro or when using rate mode on a gyro. See Pitch Curve for more information on programming curves.

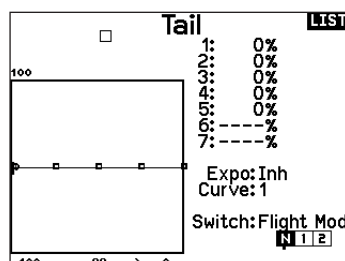

Mixing

Cyclic to Throttle

Cyclic to Throttle mix prevents rpm loss when aileron, elevator or rudder inputs are given. This mix advances the throttle position with cyclic or rudder control to maintain rpm. At full throttle, Cyclic to Throttle mixing prevents the throttle from over driving the servo.

IMPORTANT: Do not use Cyclic to Throttle mix when using a governor.

To verify that the Cyclic to Throttle mix is working properly and in the correct direction, move the flight mode switch to one of the active positions. Move the programmed cyclic or rudder channel, noting the throttle position. The throttle position should increase. If the throttle decreases, then the opposite value (positive vs. negative) is needed.

Swashplate

The Swashplate Mix typically corrects swashplate timing issues by mixing Aileron to Elevator and Elevator to Aileron. When adjusted correctly, the Swashplate causes the helicopter to roll and pitch accurately with minimal interaction.

SAIL (SAILPLANE)

CAUTION: Always do a Control Test of your model with the transmitter after programming to make sure your model responds as desired.

NOTICE: Refer to your sailplane manual for recommended control throws.

Sailplane Type

Use the Sailplane Type Screen to select wing and tail types to match your sailplane model. Diagrams and setup names show on the transmitter screen to show the available setups.

Refer to spektrumrc.com for more information about new NX10 Spektrum AirWare updates to support these options.

Wing	Tail	Motor
• 1 Servo	• Normal	• Inhibit
• 2 Aileron*	• V-Tail A**	• Assign to a
• 2 Aileron 1 Flap*	• V-Tail B**	Switch (optional)
• 2 Aileron 2 Flap*		
• 4 Aileron 2 Flap*		

*Selection of multiple ailerons activates the Differential menu option.

**“V-Tail A” and “V-Tail B” function as internal servo reversing. If V-Tail A does not work correctly with your aircraft, try V-Tail B.

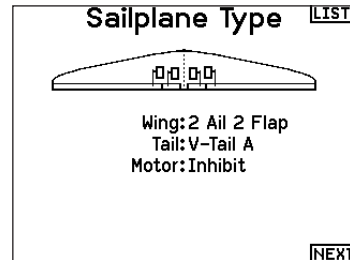

Sailplane Image

In the Sailplane Type screen, select NEXT at the bottom right of the screen. This will access the Sailplane Image screen. Click once on the image and roll the scroll wheel left or right to for optional images.



Camber Preset

Camber Preset is only available when a 2 aileron servo wing type is selected in Sailplane Type. The Camber Preset function enables you to program the ailerons, flaps, wing tips and elevator for a specific position in each Flight Mode.

If flight modes are not active, only one preset position is available and it is always active.

The Camber Preset Speed enables the control surfaces to transition over a period of time, up to 30 seconds, when you change flight modes.

Move the flight mode switch to the desired position to change the Camber Preset values.

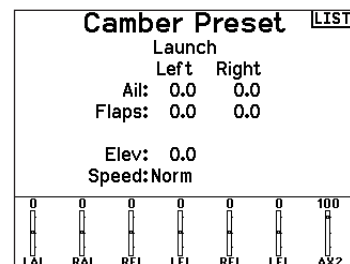

Camber System

Camber System is only available when 2 aileron wing type is selected in Sailplane Type. The Camber System allows in-flight camber adjustment and is also used as the braking system, often referred to as Crow or Butterfly. The Camber System enables you to assign the Camber System to a different switch in each flight mode.

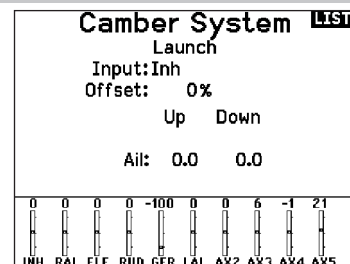

SAIL Mixing

For each of these mixes, you can program each flight mode with different mix values or at 0% if no mix is desired for that specific flight mode. Programming values include independent control of the direction and amount a slave surface moves in relationship to the master surface.

Aileron to Rudder

The Aileron to Rudder mix is commonly used for coordinated turns. When active, as aileron is applied the rudder moves in the same direction as the turn (right aileron input results in right rudder output). If you assign the flight mode to a switch, a Sub Switch option allows you to assign an additional switch to activate up to 3 Aileron to Rudder mixes for that flight mode.

Aileron to Flap

The Aileron to Flap mix allows the entire trailing edge of the wing (aileron and flap) to operate as ailerons. When active, as aileron is applied the flaps also move. Always program the flaps to move in the same direction as the turn (so that right aileron is equivalent to flaps moving as right ailerons).

Elevator to Flap

Elevator to Flap mix creates additional lift, allowing a tighter turn. The entire trailing edge of the wing (aileron and flap) operates as flaps (camber increase) when you apply elevator. An offset is provided, which is typically used for Snap Flaps. With Snap Flap, no Elevator to Flap mix occurs until the offset value is reached. Typically, this offset is at 70% up elevator so that beyond 70% the down flap mix comes in, providing additional lift for more aggressive turning (for tight thermals or racing turns).

Flap to Elevator

Flap to Elevator mix prevents pitch up tendency that occurs when you apply Crow or Butterfly. This mix is typically used only with the Camber System. The Flap to Elevator mix operates as a curve so that the elevator moves down the most during the first 20% of flap deployment, decreases over the next 40%, then remains the same from 60 to 100% of flap travel.

For sailplanes with ailerons/tips/flaps, make sure an appropriate Sailplane Type is selected so that tips appear in the transmitter as RAIL and LAIL. Decrease or increase travel on the tip ailerons by creating an AIL > RAIL mix.

V-Tail Differential

The V-Tail Differential screen enables you to increase or decrease the amount of differential between control surface throws.

Positive Differential values decrease the amount of “down” travel without affecting the “up” travel on the opposite control surface. Negative Differential values decrease the amount of “up” travel without affecting the amount of “down” travel on the opposite control surface.

The V-Tail Differential menu option only appears when V-Tail A or V-Tail B is active in Aircraft Type.

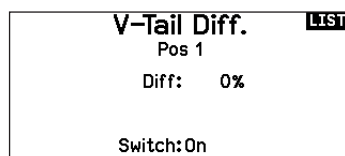
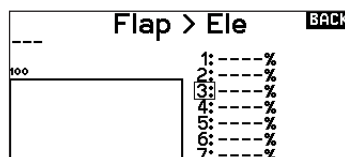
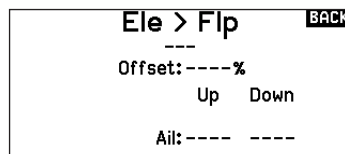
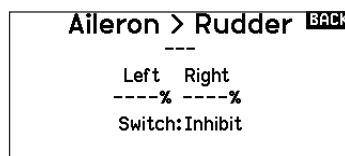
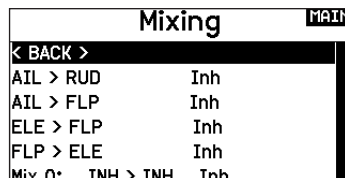

To adjust the V-Tail Differential:

1. Scroll to Switch and press the scroll wheel. Scroll right to select On (Differential is always on) or assign the differential to a switch position.
2. Press the scroll wheel a second time to save the selection.
3. Scroll to Diff: and press the scroll wheel once to change the value.
4. Press the scroll wheel again to save the selection.

MULTI (MULTIROTOR)

CAUTION: Always do a Control Test of your model with the transmitter after programming to make sure your model responds as desired.

NOTICE: Refer to your multirotor manual for programming recommendations.

The Aircraft Options menu allows you to select a camera gimbal axis. Select None, 1–Axis, 2–Axis or 3–Axis from the Camera Options box.

The model icon can be changed by selecting the icon and scrolling left or right to select.

Multicopter Image

In the Aircraft Options screen, roll to the image. Click once on the image and roll the roller left or right for optional images.

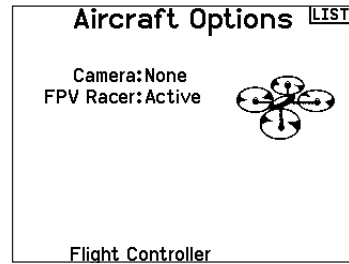

F-Mode Setup

By default switch B is assigned 3 Flight Modes. You can assign up to five flight modes using any combination of up to two switches.

Channel Assign

Scroll and Select Channel to assign channel inputs and outputs for each Flight Mode. Each channel can be assigned any switch on the transmitter including but not limited to trim switches, gimbals and the Clear/Back buttons.

EXAMPLE: Assign Flight Mode 1 to be your primary flight mode where your gimbals control primary flight axis. Switching to Flight Mode 2, you can have the gimbals control the camera axis and the trim buttons control primary flight axis.

TIP: You can also access the Channel Assign from the Channel Assign Menu in System Setup.

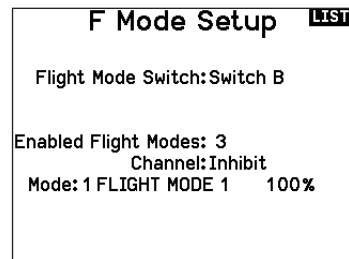

Trim Setup

By default Trims are setup for **F Mode**, and the trim steps are defaulted to zero for multirotors. If you want to utilize trim in multirotor mode, increase the trim step values above zero.

F Mode trim type enables you to save trim values for individual flight modes if you find, for example, the aircraft requires Roll trim in Flight Mode 1 but not in Flight Mode 2.

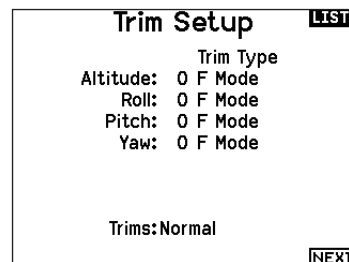

D/R and Exponential

Dual Rates and Exponential are available on the PIT, ROL and YAW channels.

To adjust the Dual Rate and Exponential:

1. Scroll to the channel and press the scroll wheel once. Scroll left or right to select the channel you wish to change and press the scroll wheel again to save the selection.
2. Scroll to Switch and press the scroll wheel to select. Move the switch you want to assign to D/R.
3. Scroll to dual rate and press the scroll wheel. Scroll left or right to change the value and press the scroll wheel again to save the selection.

Exponential affects control response sensitivity around center but has no effect on overall travel. Positive exponential decreases the sensitivity around the center of gimbal movement.

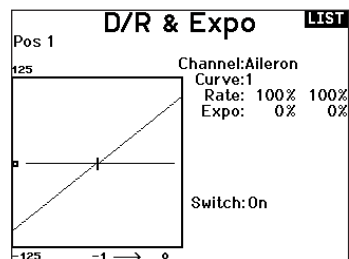

Motor Cut

The Motor Cut menu option enables you to assign a switch position to stop the motor. Motor Cut activates regardless of Flight Mode.

When you activate Motor Cut, the ALT channel moves to the pre-programmed position (normally Off).

You may need to use a negative value to move the ALT channel to the off position.



CAUTION: Always test the model after making adjustments to make sure the model responds to controls as desired.

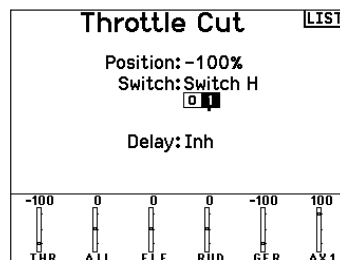

Motor Curve

You can use the Motor Curve menu option to optimize the throttle response. A maximum of 7 points are available on the throttle curve.

To add points to a Motor Curve:

1. Move the throttle stick to the position where you wish to add the new point.
2. Scroll to Add Pt. and press the scroll wheel to add the point.

To remove points from a Motor Curve:

1. Move the motor stick until the cursor is near the point you wish to remove.
2. Scroll to Remove Pt. and press the scroll wheel once to remove the point.

If you program multiple throttle curves and you wish to edit one of the curves, that curve must be active in the Motor Curve screen before you can make any changes.

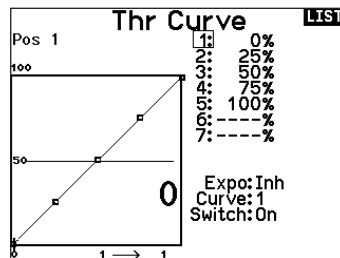

PHYSICAL TRANSMITTER ADJUSTMENTS

The NX10 has all the physical transmitter adjustments located around the gimbal face of each gimbal. This arrangement allows for quick and easy adjustments without taking the back cover off or removing any plugs to access adjustment screws.

Available adjustments:

- Change the Throttle Ratchet
- Change the Throttle Tension
- Adjust Stick Tension

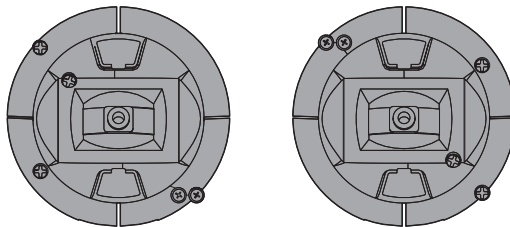

Adjust Stick Tension

Turn the screws clockwise a small amount using a small Phillips screwdriver to tighten the stick tension and counter clockwise to loosen.

NOTICE: Always do a test of stick tension while turning these screws to ensure stick tension is not too loose or too tight. Tightening a screw too much can damage a spring. Loosening a screw too much can let a spring fall off and cause short-circuit in the transmitter.

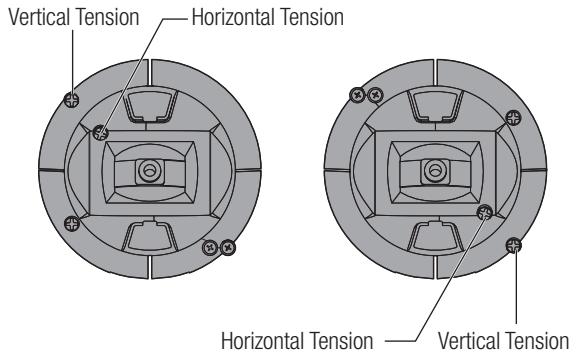

Control Stick Length Adjustment

1. Using a 2mm Allen wrench, turn the setscrew in the stick counterclockwise to loosen it.
2. Make the stick shorter by turning it clockwise or longer by turning it counterclockwise.
3. After adjustment of stick length, tighten the setscrew.

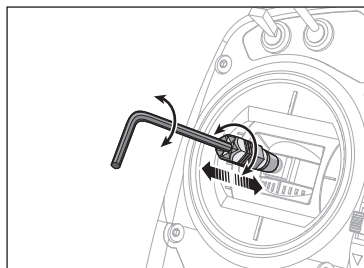

Gimbal Travel Limit

Each gimbal has a switch at the top and bottom that can limit the travel on that stick's vertical movement.

Adjusting the gimbal travel limits

1. Remove the covers
2. Move the switches toward the center of the transmitter to use the full travel available.
Move the switch to the outside of the case to reduce travel.

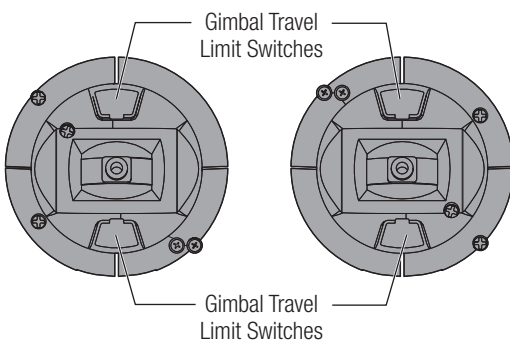

Ratcheted Throttle – Smooth Throttle Adjustment

Ratchet

1. Locate the throttle strap adjustment screws on both gimbals.
The ratchet set screw engages a serrated section on the gimbal for a ratcheted throttle, while the tension set screw engages a strap for smooth tension on the gimbal.
2. To engage the throttle ratchet turn the ratchet set screw clockwise until the ratchet engages.
3. To disengage the throttle ratchet turn the screw counter clockwise until the gimbal moves freely.

Smooth Tension

1. To engage the throttle tension, turn the tension set screw clockwise until the Tension engages.
2. To disengage the throttle Tension turn the screw counter clockwise until the gimbal moves freely.

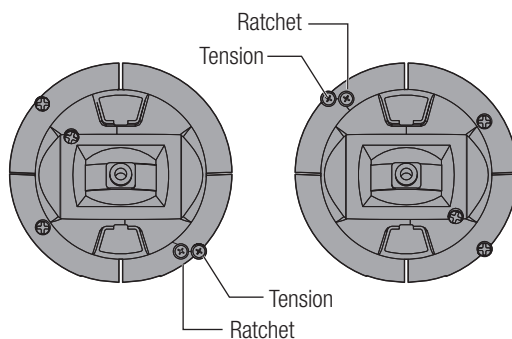

Antenna Position

We recommend setting up your antenna to be positioned vertical when you are in your most comfortable position for flying. The antenna may also be folded for storage.

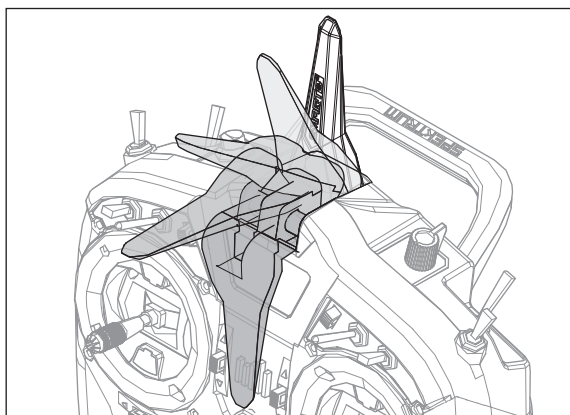

Mode Conversion

You can select transmitter modes 1, 2, 3 or 4 for the NX10. Converting the mode requires both a programming and a mechanical change.

Programming Conversion

1. Change the mode within the System Setup -> System Settings.
2. Calibrate the sticks within the System Settings menu.

Mechanical Conversion

Mechanical conversion is required to change between Modes 1 and 2 or between Modes 3 and 4. The mechanical conversion consists of the following steps:

1. Change the throttle ratchet/throttle tension; remove the tension on the side that was throttle, and apply the tension on the side that will be throttle.
2. Adjust the elevator centering screw. When changing between modes 1 and 2, or between modes 3 and 4, you must adjust the elevator centering screw.
 - a. Hold the elevator or throttle stick in the full up or full down position when you are adjusting the elevator centering screw. Holding the gimbal stick reduces the load on the elevator centering mechanism and makes it easier to adjust the centering screw.
 - b. Use a Phillips screwdriver to adjust the elevator centering screw. Tightening the screw will disengage the centering spring. Loosening the screw will engage the spring.

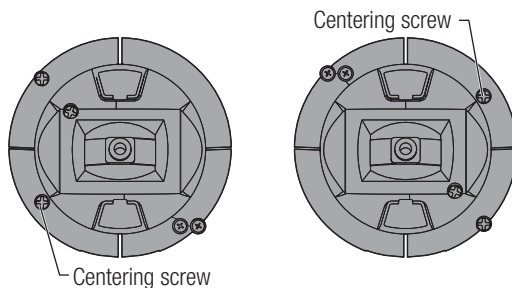

IMPORTANT: Do not remove the mode change screws too far or you will have to open the case to put it back together.

TROUBLESHOOTING GUIDE

Problem	Possible Cause	Solution
Aircraft will not bind (during binding) to transmitter	Transmitter too near aircraft during binding process	Move powered transmitter a few feet from aircraft, disconnect and reconnect flight battery to aircraft
	Aircraft or transmitter is too close to large metal object	Move the aircraft or transmitter away from the large metal object
	The bind plug is not installed correctly in the bind port	Install bind plug in bind port and bind the aircraft to the transmitter
	Flight battery/Transmitter battery charge is too low	Replace/recharge batteries
	Transmitter is a NX10 EU version and receiver is DSM2	The NX10 EU version is not compatible with DSM2 receivers
Aircraft will not link (after binding) to transmitter	Transmitter too near aircraft during linking process	Move powered transmitter a few feet from aircraft, disconnect and reconnect flight battery to aircraft
	Aircraft or transmitter is too close to large metal object	Move the aircraft or transmitter away from the large metal object
	Bind plug left installed in bind port	Rebind transmitter to the aircraft and remove the bind plug before cycling power
	Aircraft bound to different model memory (ModelMatch™ radios only)	Select correct model memory on transmitter
	Flight battery/transmitter battery charge is too low	Replace/recharge batteries
	Transmitter may have been bound using different DSM protocol	Bind aircraft to transmitter
	Damaged remote receiver or receiver extension.	Required remote receiver is not connected
The receiver goes into failsafe mode a short distance away from the transmitter	Check the receiver antenna to be sure it is not cut or damaged	Replace or contact Horizon Product Support
	Main and remote receivers too near each other	Install main and remote receivers at least 2 inches (51mm) apart
Receiver quits responding during operation	Low battery voltage	Completely recharge flight battery
	Loose or damaged wires or connectors between battery and receiver	Do a check of the wires and connection between battery and receiver. Repair or replace wires and/or connectors
Receiver loses its bind	Bind button pressed before transmitter powered on	Rebind by performing binding instructions
Receiver slowly blinking at landing (DSM2 Only)	Loss of power to the receiver during flight	Check battery voltage
	System powered on and connected, then receiver powered off without powering off transmitter	Power off transmitter when receiver is powered off
Flight log registers undesirable number of fades, losses or holds or aircraft responds irregularly to controls	Poor signal reception	Reposition remote receivers for improved RF signal path diversity
	Electronic feedback	Check for and stop feedback from servos or motor systems to the ESC or receiver
	Low power	Check aircraft power draw and increase battery power or decrease power demand by installed systems. Ensure all aircraft batteries are fully charged. Ensure the installed BEC for an electric aircraft is adequate for the power demand

1-YEAR LIMITED WARRANTY

What this Warranty Covers

Horizon Hobby, LLC, (Horizon) warrants to the original purchaser that the product purchased (the "Product") will be free from defects in materials and workmanship for a period of 1 year from the date of purchase.

What is Not Covered

This warranty is not transferable and does not cover (i) cosmetic damage, (ii) damage due to acts of God, accident, misuse, abuse, negligence, commercial use, or due to improper use, installation, operation or maintenance, (iii) modification of or to any part of the Product, (iv) attempted service by anyone other than a Horizon Hobby authorized service center, (v) Product not purchased from an authorized Horizon dealer, (vi) Product not compliant with applicable technical regulations or (vii) use that violates any applicable laws, rules, or regulations.

OTHER THAN THE EXPRESS WARRANTY ABOVE, HORIZON MAKES NO OTHER WARRANTY OR REPRESENTATION, AND HEREBY DISCLAIMS ANY AND ALL IMPLIED WARRANTIES, INCLUDING, WITHOUT LIMITATION, THE IMPLIED WARRANTIES OF NON-INFRINGEMENT, MERCHANTABILITY AND FITNESS FOR A PARTICULAR PURPOSE. THE PURCHASER ACKNOWLEDGES THAT THEY ALONE HAVE DETERMINED THAT THE PRODUCT WILL SUITABLY MEET THE REQUIREMENTS OF THE PURCHASER'S INTENDED USE.

Purchaser's Remedy

Horizon's sole obligation and purchaser's sole and exclusive remedy shall be that Horizon will, at its option, either (i) service, or (ii) replace, any Product determined by Horizon to be defective. Horizon reserves the right to inspect any and all Product(s) involved in a warranty claim. Service or replacement decisions are at the sole discretion of Horizon. Proof of purchase is required for all warranty claims. SERVICE OR REPLACEMENT AS PROVIDED UNDER THIS WARRANTY IS THE PURCHASER'S SOLE AND EXCLUSIVE REMEDY.

Limitation of Liability

HORIZON SHALL NOT BE LIABLE FOR SPECIAL, INDIRECT, INCIDENTAL OR CONSEQUENTIAL DAMAGES, LOSS OF PROFITS OR PRODUCTION OR COMMERCIAL LOSS IN ANY WAY, REGARDLESS OF WHETHER SUCH CLAIM IS BASED IN CONTRACT, WARRANTY, TORT, NEGLIGENCE, STRICT LIABILITY OR ANY OTHER THEORY OF LIABILITY, EVEN IF HORIZON HAS BEEN ADVISED OF THE POSSIBILITY OF SUCH DAMAGES. Further, in no event shall the liability of Horizon exceed the individual price of the Product on which liability is asserted. As Horizon has no control over use, setup, final assembly, modification or misuse, no liability shall be assumed nor accepted for any resulting damage or injury. By the act of use, setup or assembly, the user accepts all resulting liability. If you as the purchaser or user are not prepared to accept the liability associated with the use of the Product, purchaser is advised to return the Product immediately in new and unused condition to the place of purchase.

Law

These terms are governed by Illinois law (without regard to conflict of law principals). This warranty gives you specific legal rights, and you may also have other rights which vary from state to state. Horizon reserves the right to change or modify this warranty at any time without notice.

WARRANTY SERVICES

Questions, Assistance, and Services

Your local hobby store and/or place of purchase cannot provide warranty support or service. Once assembly, setup or use of the Product has been started, you must contact your local distributor or Horizon directly. This will enable Horizon to better answer your

questions and service you in the event that you may need any assistance. For questions or assistance, please visit our website at www.horizonhobby.com, submit a Product Support Inquiry, or call the toll free telephone number referenced in the Warranty and Service Contact Information section to speak with a Product Support representative.

Inspection or Services

If this Product needs to be inspected or serviced and is compliant in the country you live and use the Product in, please use the Horizon Online Service Request submission process found on our website or call Horizon to obtain a Return Merchandise Authorization (RMA) number. Pack the Product securely using a shipping carton. Please note that original boxes may be included, but are not designed to withstand the rigors of shipping without additional protection. Ship via a carrier that provides tracking and insurance for lost or damaged parcels, as Horizon is not responsible for merchandise until it arrives and is accepted at our facility. An Online Service Request is available at http://www.horizonhobby.com/content/service-center_render-service-center. If you do not have internet access, please contact Horizon Product Support to obtain a RMA number along with instructions for submitting your product for service. When calling Horizon, you will be asked to provide your complete name, street address, email address and phone number where you can be reached during business hours. When sending product into Horizon, please include your RMA number, a list of the included items, and a brief summary of the problem. A copy of your original sales receipt must be included for warranty consideration. Be sure your name, address, and RMA number are clearly written on the outside of the shipping carton.

NOTICE: Do not ship LiPo batteries to Horizon. If you have any issue with a LiPo battery, please contact the appropriate Horizon Product Support office.

Warranty Requirements

For Warranty consideration, you must include your original sales receipt verifying the proof-of-purchase date. Provided warranty conditions have been met, your Product will be serviced or replaced free of charge. Service or replacement decisions are at the sole discretion of Horizon.

Non-Warranty Service

Should your service not be covered by warranty, service will be completed and payment will be required without notification or estimate of the expense unless the expense exceeds 50% of the retail purchase cost. By submitting the item for service you are agreeing to payment of the service without notification. Service estimates are available upon request. You must include this request with your item submitted for service. Non-warranty service estimates will be billed a minimum of ½ hour of labor. In addition you will be billed for return freight. Horizon accepts money orders and cashier's checks, as well as Visa, MasterCard, American Express, and Discover cards. By submitting any item to Horizon for service, you are agreeing to Horizon's Terms and Conditions found on our website http://www.horizonhobby.com/content/service-center_render-service-center.

ATTENTION: Horizon service is limited to Product compliant in the country of use and ownership. If received, a non-compliant Product will not be serviced. Further, the sender will be responsible for arranging return shipment of the un-serviced Product, through a carrier of the sender's choice and at the sender's expense. Horizon will hold non-compliant Product for a period of 60 days from notification, after which it will be discarded.

WARRANTY AND SERVICE CONTACT INFORMATION

Country of Purchase	Horizon Hobby	Contact Information	Address
United States of America	Horizon Service Center (Repairs and Repair Requests)	servicecenter.horizonhobby.com/RequestForm/	
	Horizon Product Support (Product Technical Assistance)	productsupport@horizonhobby.com	2904 Research Rd Champaign, Illinois, 61822 USA
		877-504-0233	
Sales	websales@horizonhobby.com		
EU	Horizon Technischer Service	service@horizonhobby.de	Hanskampring 9 D 22885 Barsbüttel, Germany
	Sales: Horizon Hobby GmbH	+49 (0) 4121 2655 100	

FCC INFORMATION

Contains FCC ID: BRWPLAN01T

Contains FCC ID: BRWWAC01T

Contains FCC ID: 2AC7Z-ESPWROOM02

This equipment complies with FCC and IC radiation exposure limits set forth for an uncontrolled environment. This equipment should be installed and operated with minimum distance 20cm between the radiator and/or antenna and your body (excluding fingers, hands, wrists, ankles and feet). This transmitter must not be co-located or operating in conjunction with any other antenna or transmitter.

Supplier's Declaration of Conformity

FCC Spektrum NX10 Transmitter Only (SPMR10100): This device complies with part 15 of the FCC Rules. Operation is subject to the following two conditions: (1) This device may not cause harmful interference, and (2) this device must accept any interference received, including interference that may cause undesired operation.



CAUTION: changes or modifications not expressly approved by the party responsible for compliance could void the user's authority to operate the equipment.

NOTE: This equipment has been tested and found to comply with the limits for a Class B digital device, pursuant to part 15 of the FCC Rules. These limits are designed to provide

reasonable protection against harmful interference in a residential installation. This equipment generates, uses and can radiate radio frequency energy and, if not installed and used in accordance with the instructions, may cause harmful interference to radio communications. However, there is no guarantee that interference will not occur in a particular installation. If this equipment does cause harmful interference to radio or television reception, which can be determined by turning the equipment off and on, the user is encouraged to try to correct the interference by one or more of the following measures:

- Reorient or relocate the receiving antenna.
- Increase the separation between the equipment and receiver.
- Connect the equipment into an outlet on a circuit different from that to which the receiver is connected.
- Consult the dealer or an experienced radio/TV technician for help.

Horizon Hobby, LLC
2904 Research Rd.,
Champaign, IL 61822
Email: compliance@horizonhobby.com
Web: HorizonHobby.com

IC INFORMATION

CAN ICES-3 (B)/NMB-3(B)

Contains IC: 6157A-PLAN01T

Contains IC: 6157A-WAC01T

Contains IC: 21098-ESPWROOM02

This device complies with ISED licence-exempt RSS standard(s). Operation is subject to the following two conditions:

(1) this device may not cause interference, and (2) this device must accept any interference, including interference that may cause undesired operation of the device.

COMPLIANCE INFORMATION FOR THE EUROPEAN UNION



EU Compliance Statement:

Spektrum NX10 Transmitter Only (SPMR10100);

Hereby, Horizon Hobby, LLC declares that the device is in compliance with the following: EU Radio Equipment Directive 2014/53/EU; RoHS 2 Directive 2011/65/EU; RoHS 3 Directive - Amending 2011/65/EU Annex II 2015/863. The full text of the EU declaration of conformity is available at the following internet address: <https://www.horizonhobby.com/content/support-render-compliance>.

NOTE: This product contains batteries that are covered under the 2006/66/EC European Directive, which cannot be disposed of with normal household waste. Please follow local regulations.

Wireless Frequency Range and Wireless Output Power:

Control and Trainer: 2402-2478 MHz / WiFi: 2412-2462 MHz
Control: 18.7 dBm / Trainer: 1.43 dBm / WiFi: 18.5dBm

EU Manufacturer of Record:

Horizon Hobby, LLC
2904 Research Road
Champaign, IL 61822 USA

EU Importer of Record:

Horizon Hobby, GmbH
Hanskampring 9
22885 Barsbüttel Germany

WEEE NOTICE:



This appliance is labeled in accordance with European Directive 2012/19/EU concerning waste of electrical and electronic equipment (WEEE). This label indicates that this product should not be disposed of with household waste. It should be deposited at an appropriate facility to enable recovery and recycling.



E328

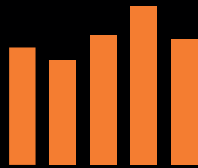

SPEKTRUM®

© 2021 Horizon Hobby, LLC

DSM, DSM2, DSMX, the DSMX logo, Bind-N-Fly, BNF, the BNF logo, Spektrum AirWare, STI, ModelMatch, AS3X, SmartSafe, and the Horizon Hobby logo are trademarks or registered trademarks of Horizon Hobby, LLC.

The Spektrum trademark is used with permission of Bachmann Industries, Inc.

US 7,391,320. US 9,930,567. US 10,419,970. US 10,849,013. Other patents pending.

www.spektrumrc.com

Updated 11/2021

59745.3

SPMR10100