

SLAYER PRO 4X4 Engine Assembly

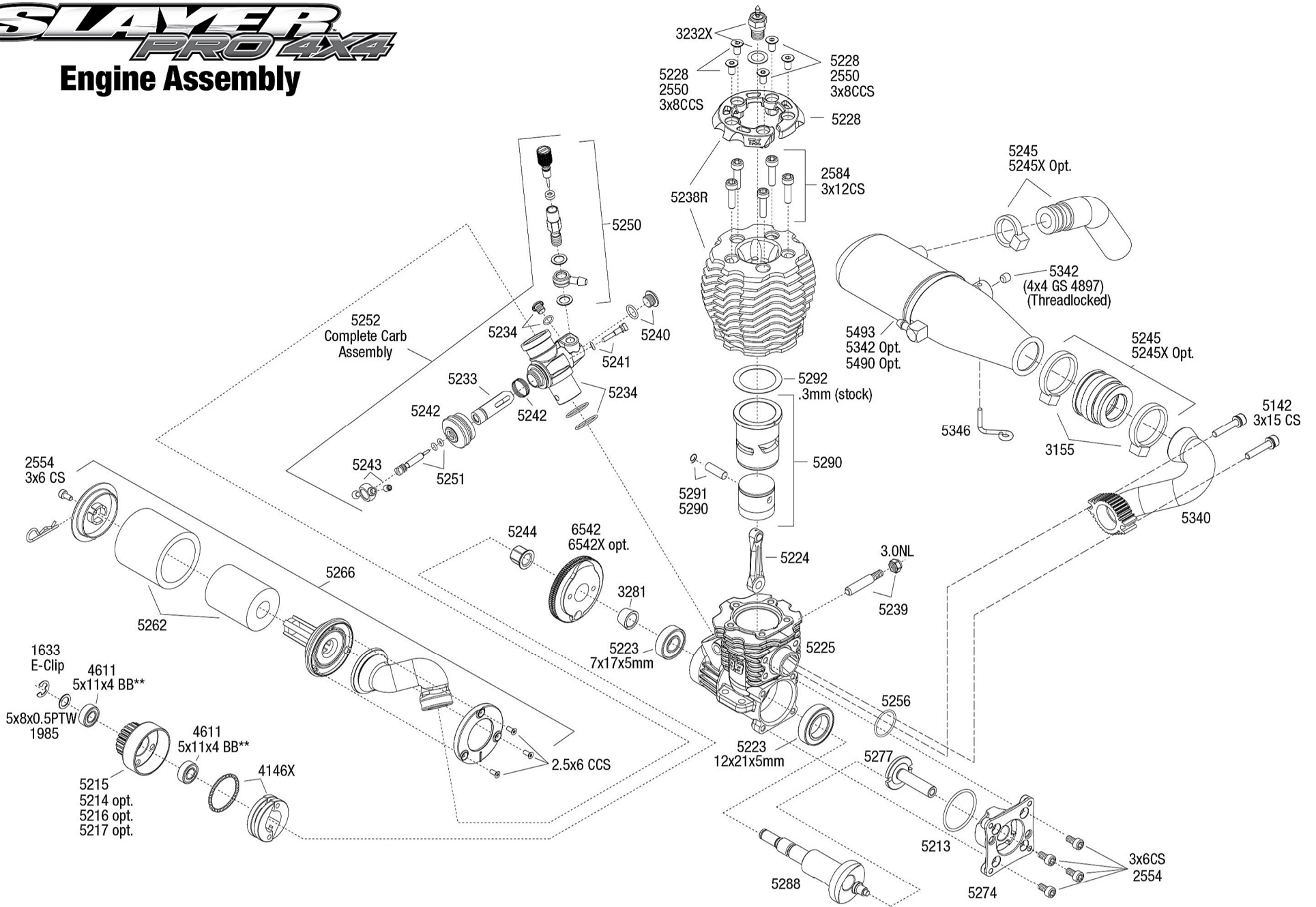

Specifications on this page are subject to change without notice. Every attempt has been made to ensure the accuracy of this drawing, however Traxxas cannot be held responsible for typographical or other errors. See Parts List for a complete listing of optional accessories.

REV 180216-R03

SLAYER PRO 4X4

Front Assembly

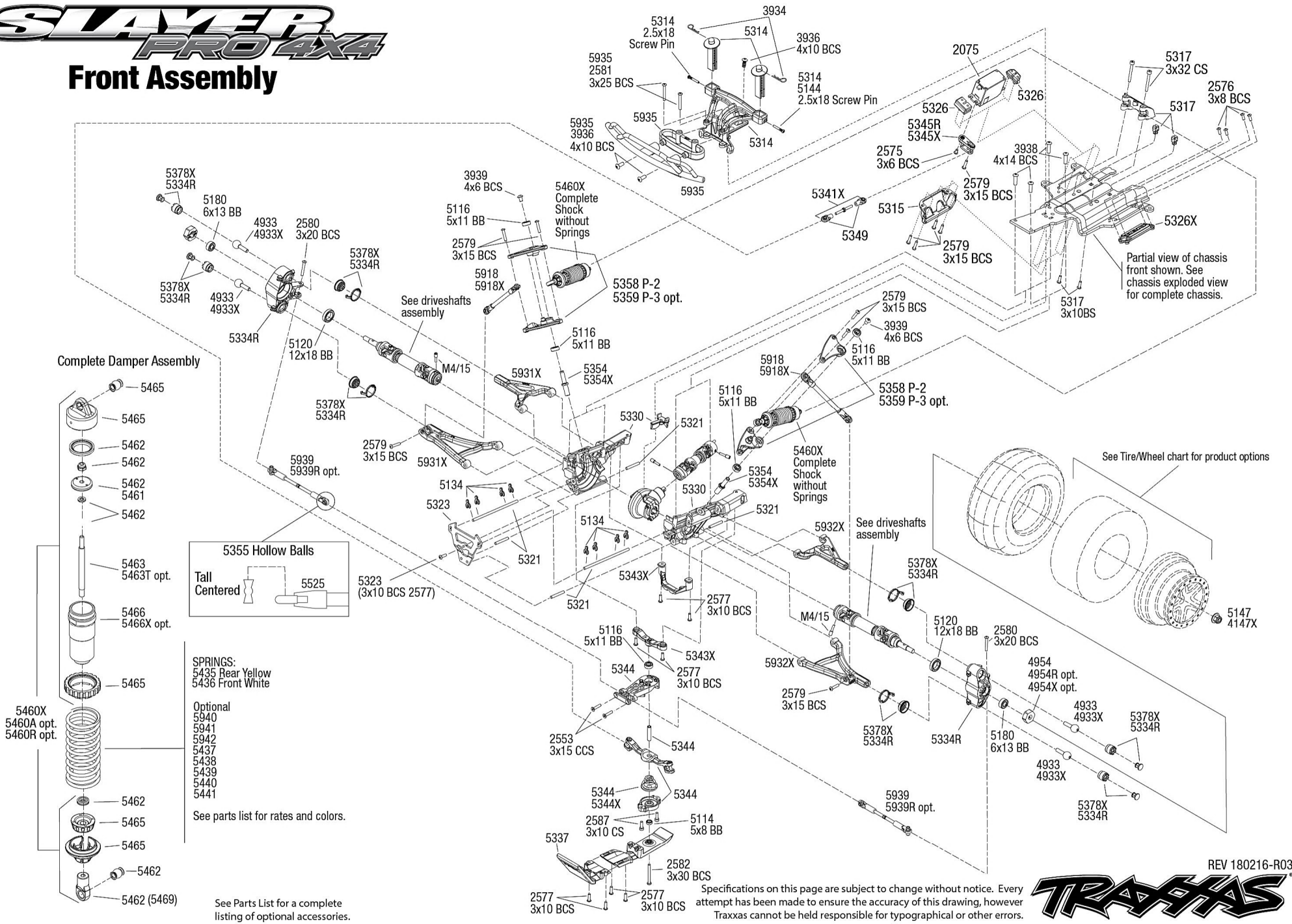

REV 180216-R03



SLAYER PRO 4X4

Rear Assembly

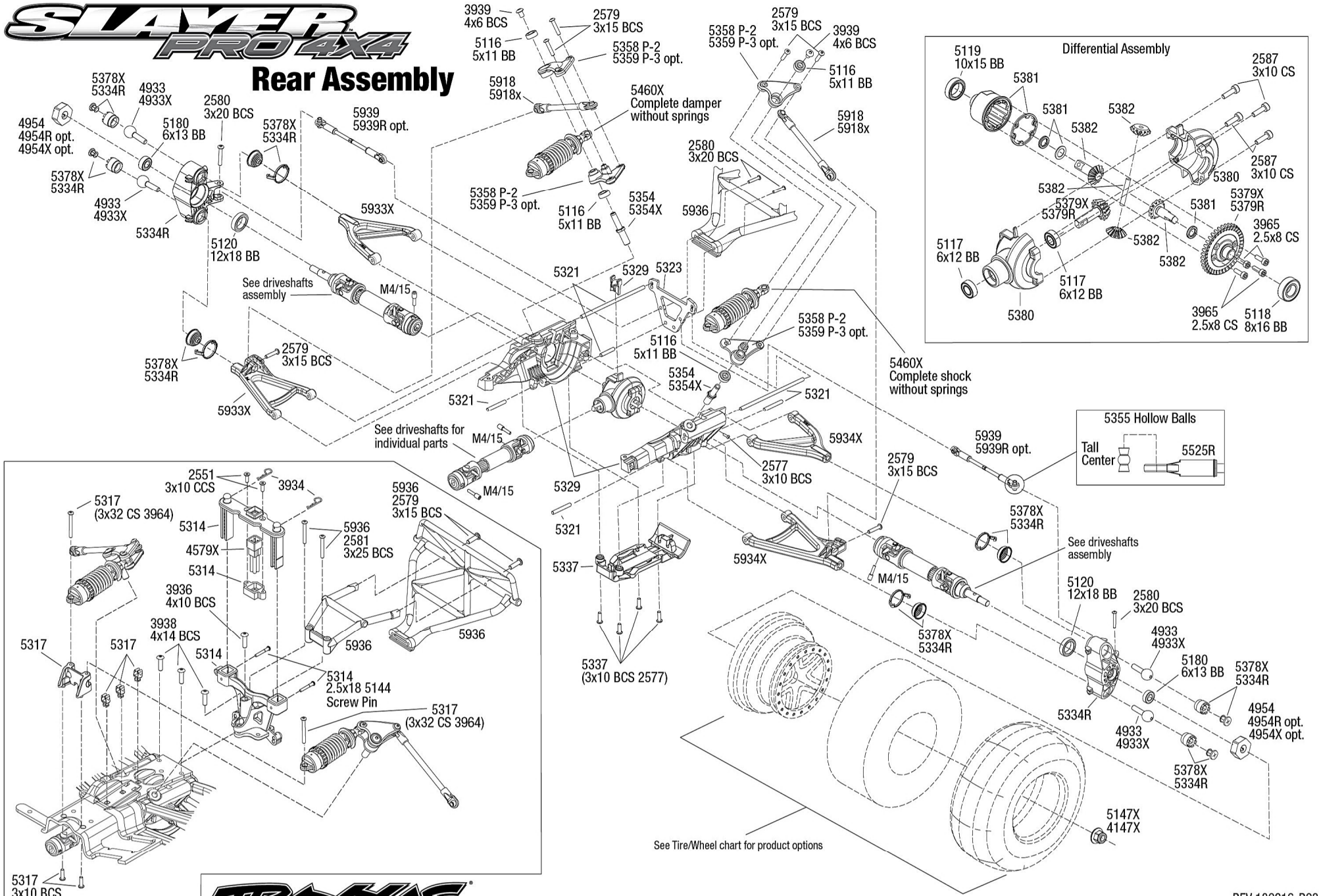

See Parts List for a complete listing of optional accessories.

Specifications on this page are subject to change without notice. Every attempt has been made to ensure the accuracy of this drawing, however Traxxas cannot be held responsible for typographical or other errors.

REV 180216-R03

SLAYER PRO 4X4

Wheel and Tire Chart

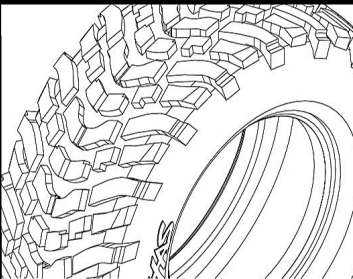
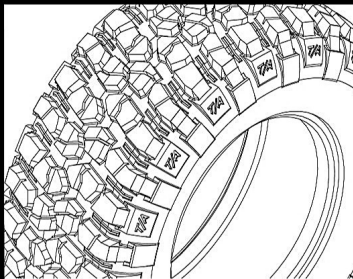
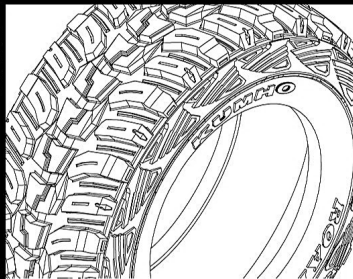
					
Traxxas SCT Tires with Foam Inserts		BFGoodrich® Mud Terrain™ T/A® Tires with Foam Inserts		Kumho Road Venture MT tires with Foam Inserts	
5871	<i>S1 Ultra-Soft Racing Compound</i> 5871R	6871	<i>S1 Ultra-Soft Racing Compound</i> 6871R	6870	<i>S1 Ultra-Soft Racing Compound</i> 6870R

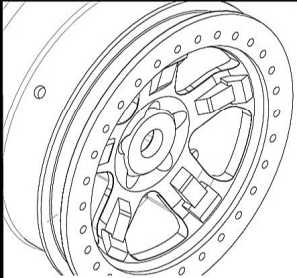
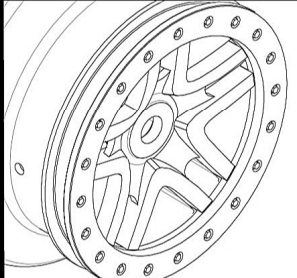
Wheels*		Assembled Wheels and Tires		Assembled Wheels and Tires		Assembled Wheels and Tires	
 Traxxas SCT Wheels (14mm hex)	Satin Beadlock/ Satin Wheel <i>Slayer Front/Rear</i>	5972	5973	-	-	-	-
	Red Beadlock/ Satin Wheel <i>Slayer Front/Rear</i>	5972A	5973A	5973R	-	-	-
 Split Spoke Wheels (14mm hex)	Black Beadlock/ Satin Wheel <i>Slayer Front/Rear</i>	5974	-	-	5975	-	5976
	Red Beadlock/ Chrome Wheel <i>Slayer Front/Rear</i>	5974A	-	-	5975A	5975R	-

* Wheels and/or tires sold in pairs

Specifications on this page are subject to change without notice. Every attempt has been made to ensure the accuracy of this drawing, however Traxxas cannot be held responsible for typographical or other errors. See Parts List for a complete listing of optional accessories.

BFGoodrich® Tires Trademarks are used under license from Michelin Group Companies.

REV 180216-R03

SLAYER PRO 4x4

Chassis Assembly

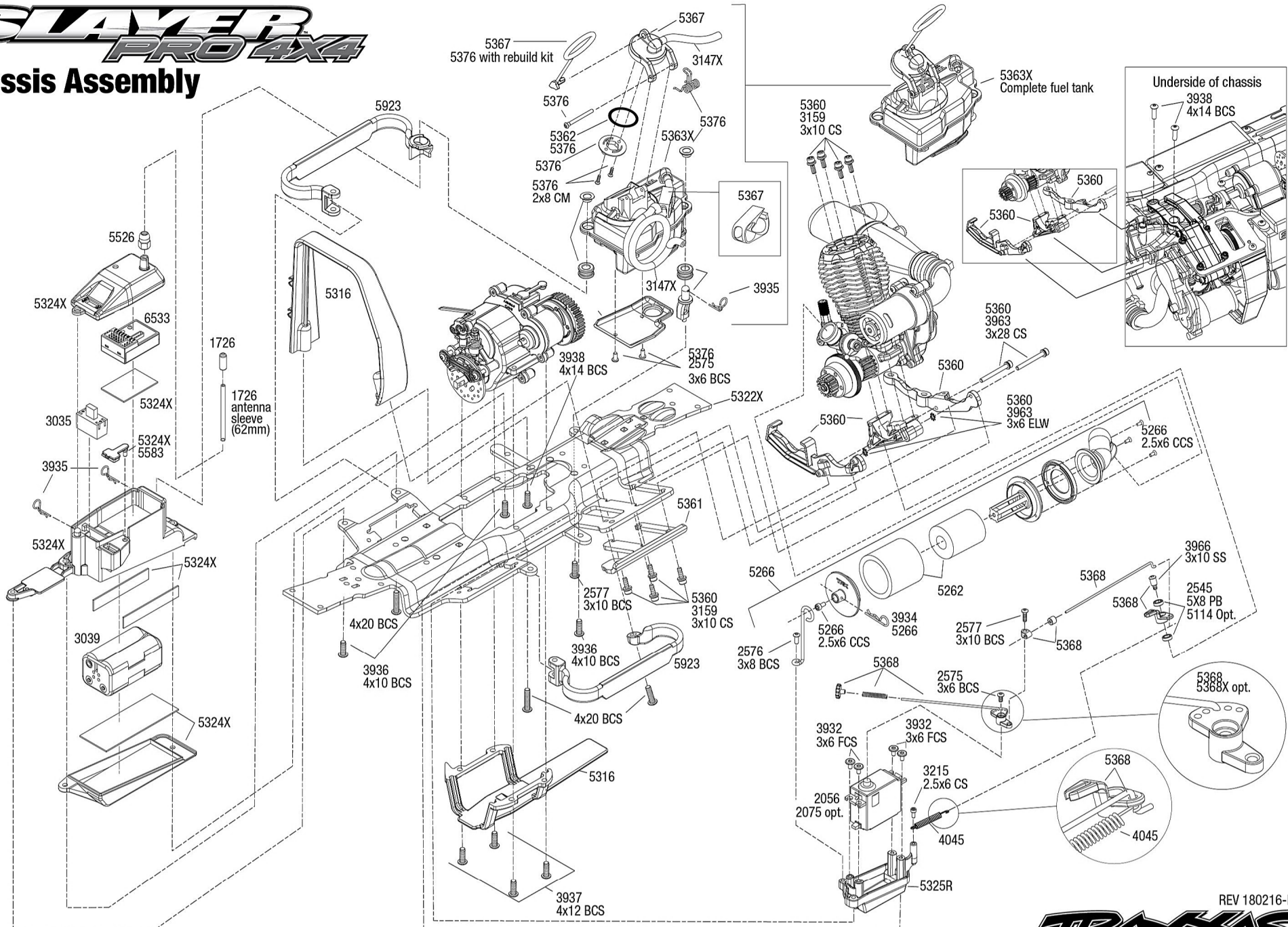

























Specifications on this page are subject to change without notice. Every attempt has been made to ensure the accuracy of this drawing, however Traxxas cannot be held responsible for typographical or other errors.

See Parts List for a complete listing of optional accessories.

REV 180216-R03

TRAXXAS

Abbreviations

	CCS	Countersunk Cap Screw
	CS	Cap Screw
	FCS	Flathead Cap Screw
	BCS	Buttonhead Cap Screw
	CM	Countersunk Machine Screw
	RM	Roundhead Machine Screw
	WM	Washerhead Machine Screw
	SS	Shoulder Screw
	CST	Countersunk Self-tapping Screw
	RST	Roundhead Self-tapping Screw
	WST	Washerhead Self-tapping Screw
	FN	Flange Nut
	NL	Nylon Locknut
	PB	Plastic Bushing
	GS	Set (Grub) Screw
	PW	Plastic Washer
	AS	Aluminum Spacer
	PTW	PTFE Washer
	MW	Metal Washer
	E	E-Clip
	SW	Split Washer
	BB	Ball Bearing
	SLB	Self-lubricating Bushing
	NRB	Needle Roller Bearing
	ELW	External Lock Washer

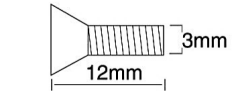

3x12mm Countersunk Machine Screw

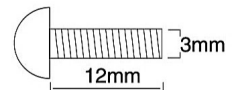

3x12mm Roundhead Machine Screw

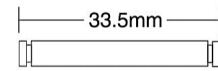

33.5mm Hinge Pin

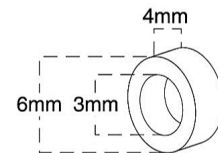

3x6x4mm Spacer

18.5 MM Yoke Pin

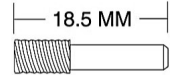

M4/18.5
4mm Thread Total Length

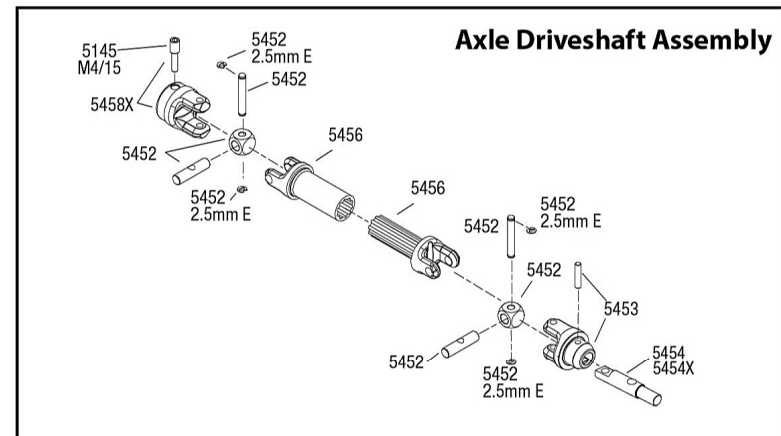
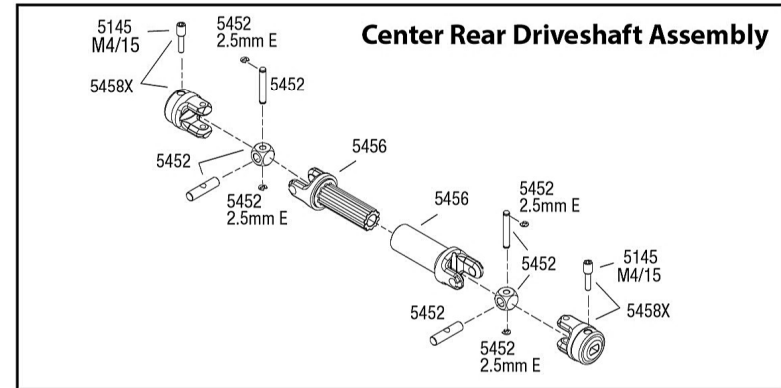
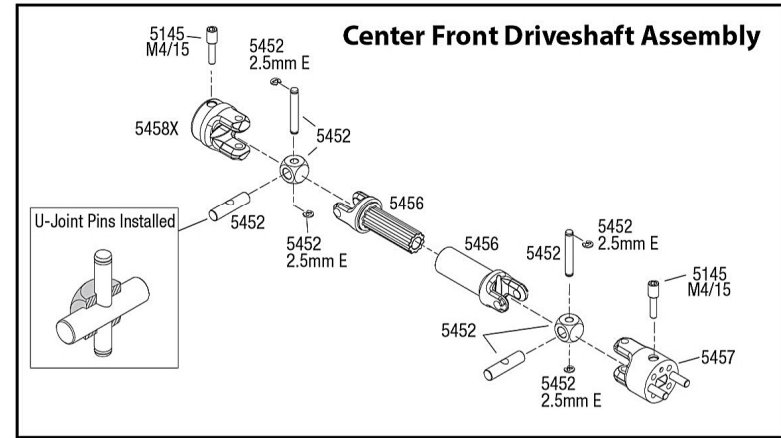

Specifications on this page are subject to change without notice. Every attempt has been made to ensure the accuracy of this drawing, however Traxxas cannot be held responsible for typographical or other errors. See Parts List for a complete listing of optional accessories.