

TRAXXAS

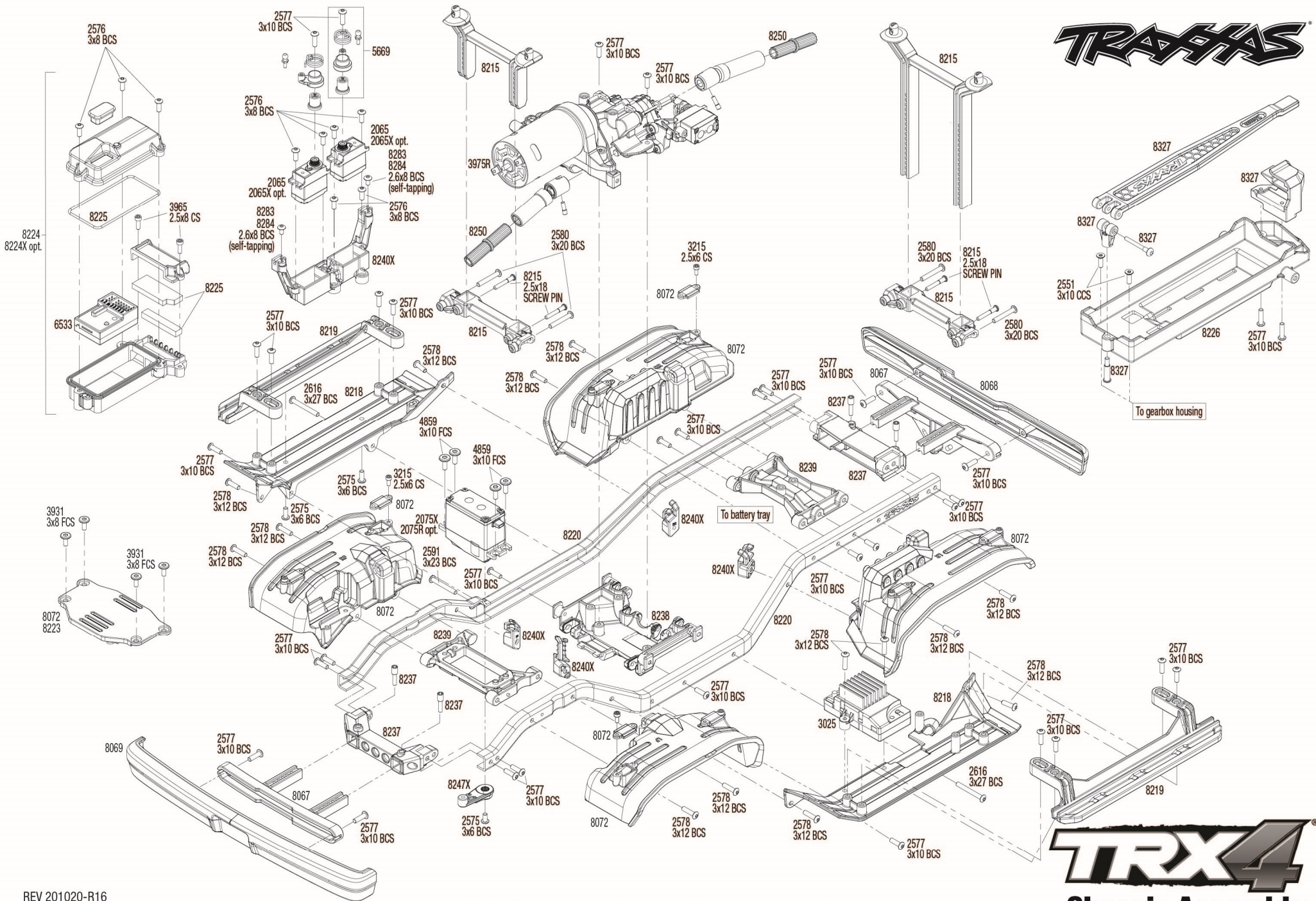

REV 201020-R16
See Parts List for a complete listing of optional accessories.

Specifications on this page are subject to change without notice. Every attempt has been made to ensure the accuracy of this drawing; however, Traxxas cannot be held responsible for typographical or other errors.

TRX4

Chassis Assembly



Link Dimensions

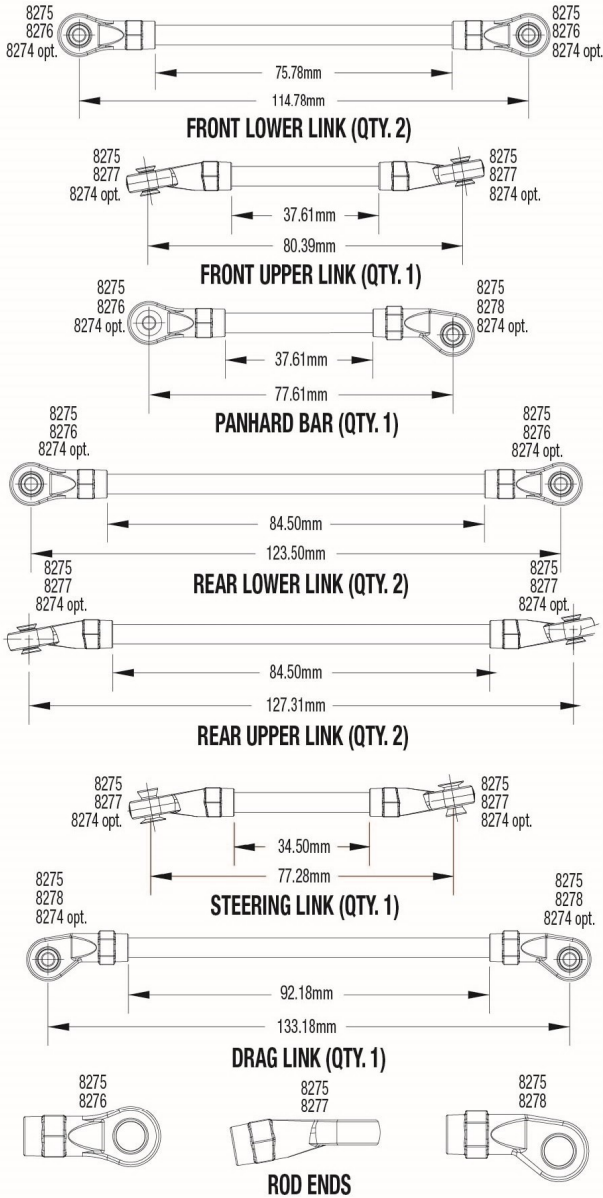

For standard hollow ball replacement, use part #5349.

Modular Assembly

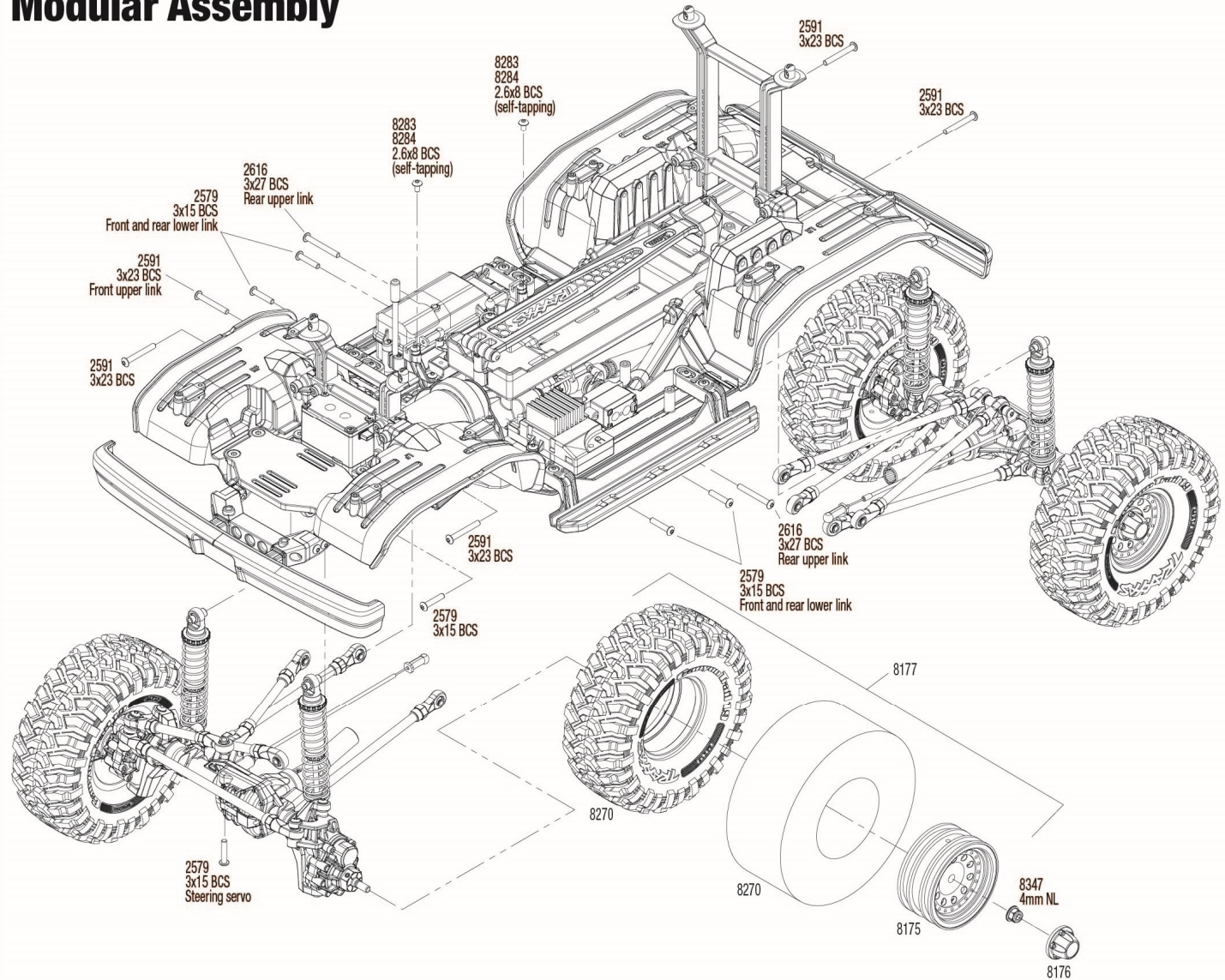

See Parts List for a complete listing of optional accessories.

Specifications on this page are subject to change without notice. Every attempt has been made to ensure the accuracy of this drawing; however, Traxxas cannot be held responsible for typographical or other errors.



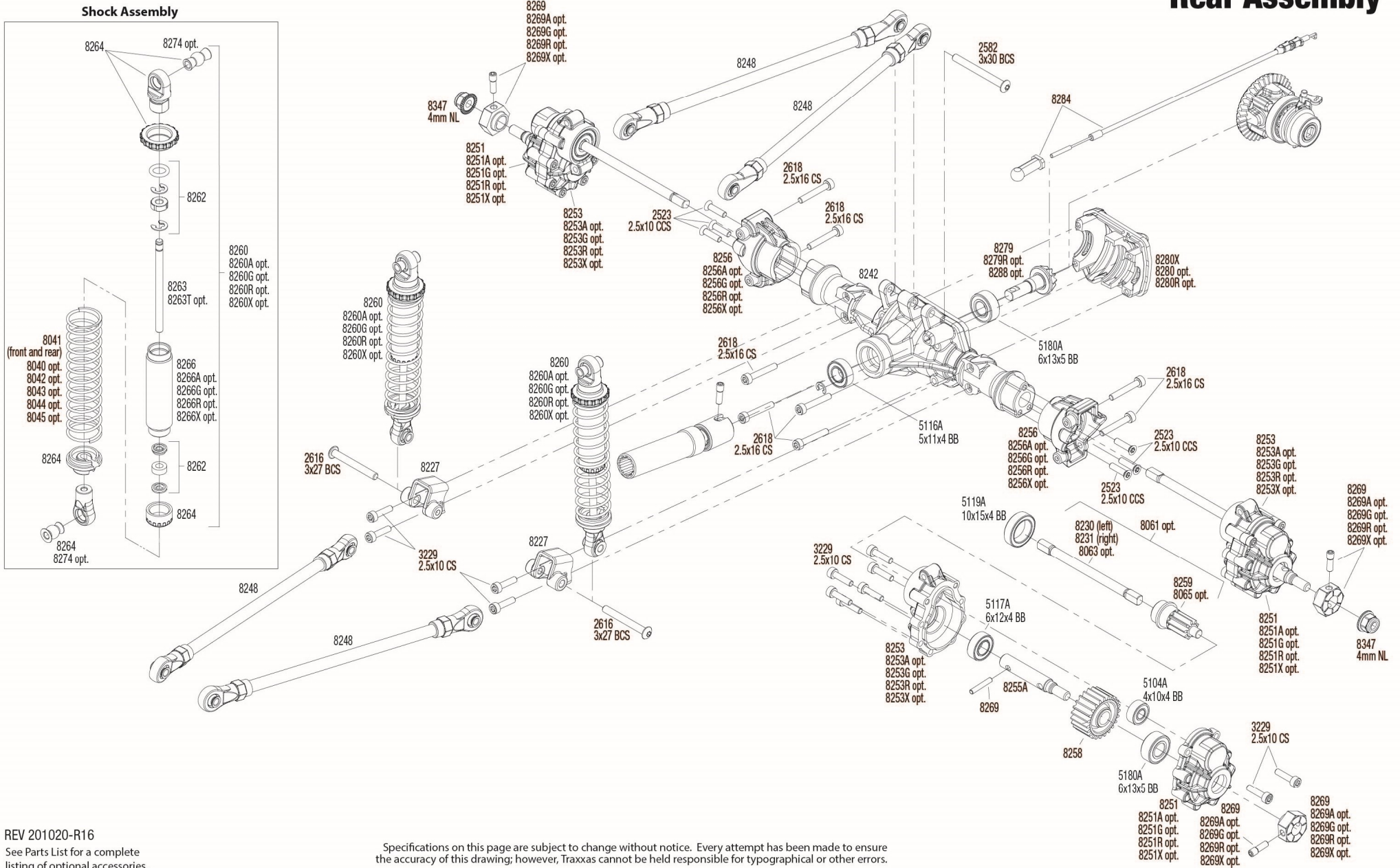



Transmission and Transfer Case Gears

Note the orientation of the gears

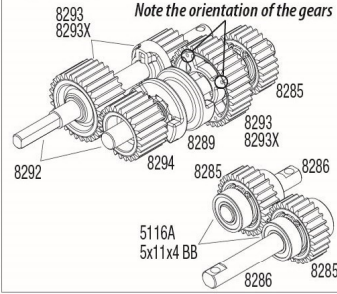

Transmission Assembly

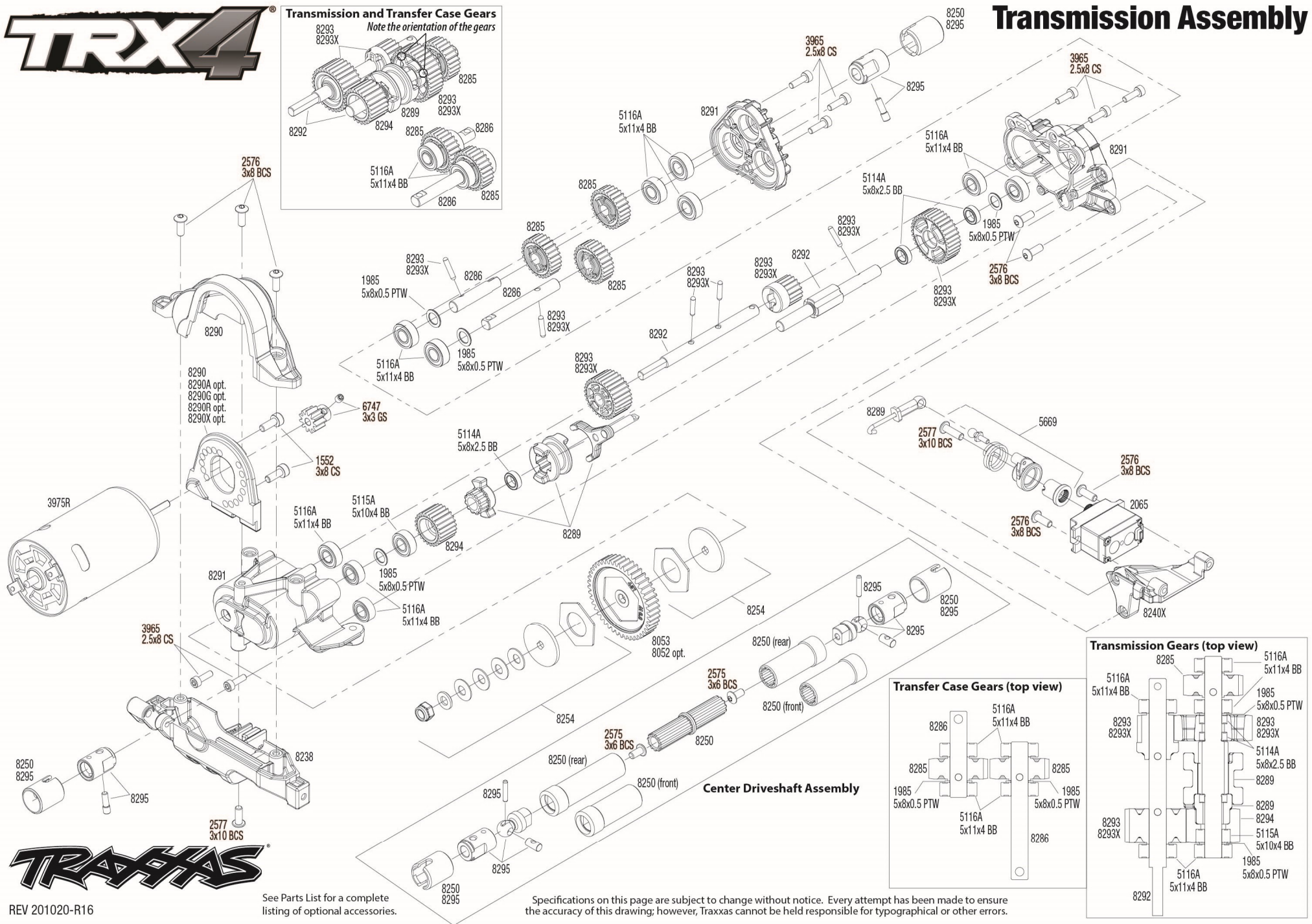

REV 201020-R16

See Parts List for a complete listing of optional accessories.

Specifications on this page are subject to change without notice. Every attempt has been made to ensure the accuracy of this drawing; however, Traxxas cannot be held responsible for typographical or other errors.

Transmission Gears (top view)

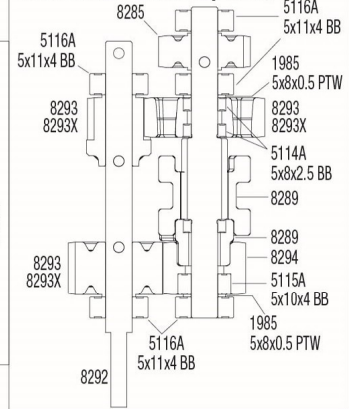

Transfer Case Gears (top view)

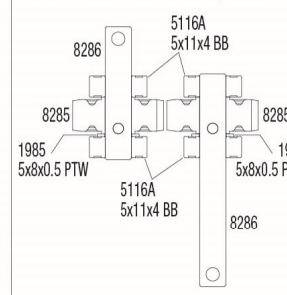

Center Driveshaft Assembly

